



BUILDING STRENGTH™

**CONDENSED
ACCESSORY HANDBOOK**

**CONCRETE
CONSTRUCTION
PRODUCTS**





Dayton Superior – We’re Here To Meet Your Needs...

Dayton Superior Concrete Accessories is one of the fine construction related divisions of the Dayton Superior Corporation. By combining quality products, service and expertise, Dayton Superior is able to serve the needs of the concrete construction industry quickly and efficiently.

Dayton Superior offers the industry the most comprehensive line of concrete accessories and construction chemicals. Dayton Superior has a full complement of accessories and equipment for light and heavy forming, form and deck hangers, inserts and anchors, rebar supports, precast, tilt-up and rebar splicing. All told, there are over 5,000 standard concrete accessory products and construction chemicals. Dayton Superior also has the capability to design and fabricate special concrete accessory items, when the need presents itself.

Dayton Superior has combined service of over 200 years in the concrete accessory field and technical expertise ready to assist you with any concreting problem that may arise. Quality products, experience, coast-to-coast plants and service centers and the industry’s largest dealer network — available to you as a valued Dayton Superior customer.

Safety Notes and Product Application

Do not use any Dayton Superior product before reading and understanding the product instructions in the appropriate Dayton Superior product publication. For maximum safety, product information must be extended to field personnel. Contractors must make sure that their employees are properly instructed in the use and installation of all concrete accessories.

The safety factor applied to a particular product is a variable, dependent on the degree of hazard or risk involved in the application of that product. In concrete construction, various job site conditions can often increase the degree of risk. Concentrated loads on the formwork, unsymmetrical placement of concrete, using a crane inadequate for the job, uplift, impact, use of motorized carts, formwork height, jerking the crane during lifting or handling, are job site conditions that may raise the degree of risk. Dayton Superior lists minimum safety factors. If a job site condition exists that increases job site risks, such as those previously stated, the user must increase the product safety factor to compensate for the job site conditions.

Dayton Superior develops products for the concrete construction industry and has stressed that the products it supplies meet or exceed all pertinent safety requirements. All tests on the products shown in this publication have been performed by Dayton Superior or independent testing laboratories.

Dayton Superior recommends that the provisions of the American National Standards Institute (Standard ANSI A 10.9), Occupational Safety and Health Administration (OSHA Part 1926) and American Concrete Institute (ACI 347 Guide to Formwork for Concrete) be strictly followed when considering safety factors and safe working loads. The minimum safety factors listed in the table below are a guide and should not be compromised. When unusual job conditions exist, these minimum safety factors must be increased by the user.

Safety Factors

ACCESSORY	MIN. SAFETY FACTOR	TYPE OF CONSTRUCTION
Form Ties	2.0	All Applications
Form Anchors	2.0	Formwork supporting form weight and concrete pressures only
	3.0	Formwork supporting weight of forms, concrete, live loads and impact
Form Hangers	2.0	All Applications
Anchoring Inserts (Used as Form Ties)	2.0	Precast concrete panels when used as formwork
Lifting Inserts	2.0	Tilt-up concrete panels
	4.0	Precast concrete elements

Dayton Superior recommends the following minimum safety factors and the provisions of OSHA Part 1926 and ANSI 10.9 when considering safety factors.

If a different safety factor is required for any reason, a product’s safe working load must be changed accordingly. The following equation is used to increase or reduce a safe working load.

$$\text{New Safe Working Load} = \frac{\text{Original Working Load} \times \text{Original Safety Factor}}{\text{New Required Safety Factor}}$$

Note: Users of Dayton Superior products must evaluate the product application, calculate induced loads, determine the necessary safety factor, calculate the safe working load and then control field conditions to prevent application of loads in excess of the calculated safe working loads.

Table of Contents

General and Technical Information.....	1
Light Forming	2
Heavy Forming	5
Form Anchorage.....	8
Form Hanger	9
Inserts	10
Other Forming Products	11
Bridge Deck Forming	12
Rebar Splicing.....	15
Bar Support — Metal.....	17
Bar Support — Plastic.....	18
Continuous Bar Support.....	19
Tilt-Up.....	20
Bracing.....	23
Precast.....	24
Paragon.....	28

A2 Plastic Cone Snap Tie

Dayton Superior's Plastic cones can be added to A3, A4, A44, A46 or A48 ties and act as positive form spreaders to aid in reducing concrete leakage. Plastic cones are available in 1", 1-1/4" and 1-1/2" nominal setbacks.

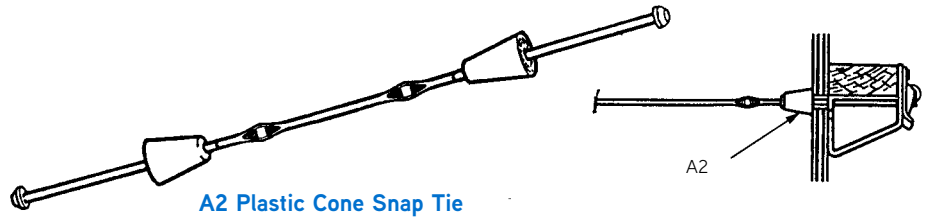

A2 Plastic Cone Snap Tie

A3 Snap Tie Standard and Heavy

Dayton Superior's A3 Snap Ties, Standard and Heavy, are equipped with 15/16" flat washers and are manufactured for specified wall thicknesses. A3 Snap Ties provide a 1" breakback from the concrete surface. Other breakbacks are available on special order.

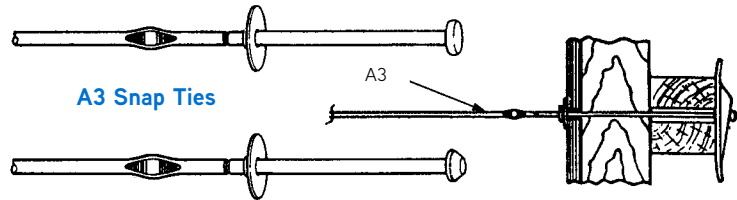

A3 Snap Ties

A4 Sure-Snap Hex Head Tie

Dayton Superior's A4 Sure-Snap Hex Head Tie is produced with hot forged hexagon heads that permit easy breakback of short-end snap ties while the formwork is still in place.

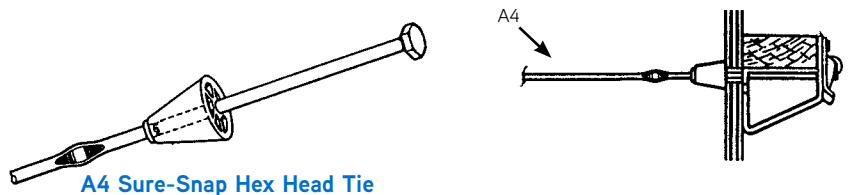

A4 Sure-Snap Hex Head Tie

A16 Omni Wedge

Dayton Superior's A16 Heavy Steel Wedge is used with any standard or heavy Dayton Superior's Snap Tie to provide a quick and easy wedging action to securely hold the tie and formwork in place.

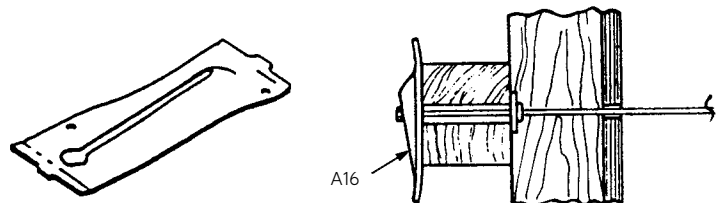

A16

A21 Flat Tie

Dayton Superior's A21 Flat Ties are available in several styles and breakbacks for use with various modular steel frame forming systems.

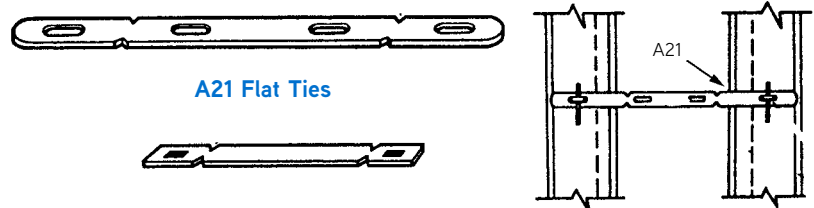

A21 Flat Ties

A27 Turnbuckle Form Aligner

Dayton Superior's A27 Turnbuckle Form Aligner is designed to align and position all types of vertical forms. It is combined in the field with any size stud to allow easy adjustment for final form positioning and alignment.

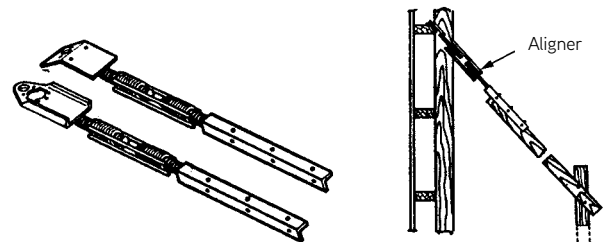

A27 Turnbuckle Form Aligners

A46 Loop Panel Tie, Standard and Heavy

Dayton Superior's A46 Loop Panel Ties are designed for use with standard modular panel forming systems; available with various breakbacks, plastic cones and and/or water resistant washer.

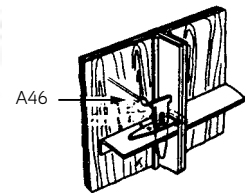

A48 Gang Loop Panel Tie, Standard and Heavy

Dayton Superior's A48 Gang Loop Panel Ties are similar to the A46 Ties, above, but have longer ends to allow them to be used with various modular systems' gang form bolts.

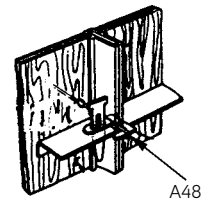

A55 Sure-Lock Tie

Dayton Superior's A55 Sure-Lock Tie is a short-end loop tie fitted with high-impact, self-centering plastic cones. The A55 Sure-Lock Tie is used with the A56 Sure-Lock Clamp or the A56A Speedy Bracket, shown below, for loose plywood forming.

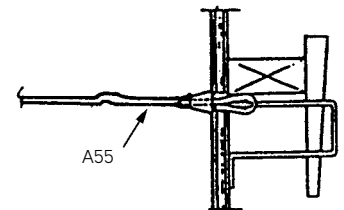
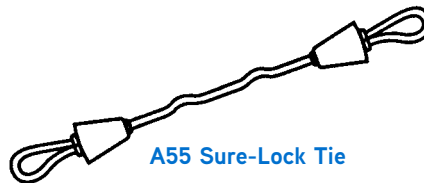

A56 Sure-Lock Bracket and A56A Speedy Bracket

Dayton Superior's A56 Sure-Lock Bracket and A56A Speedy Bracket are rugged units designed to accept the A55 Sure-Lock Tie. They will accommodate a single 2x4, 3x4 or 4x4 waler; horizontally or vertically.

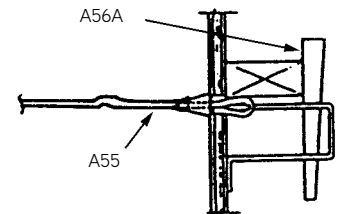
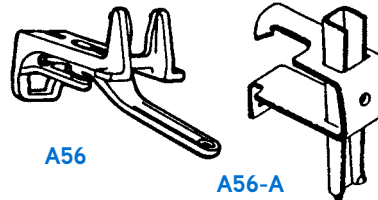

A57 Sure-Lock Strongback Clamp and A57A Stiffback Bracket

Dayton Superior's A57 Sure-Lock Strongback Clamp and A57A Stiffback Bracket are used in conjunction with the Sure-Lock Bracket or the Speedy Bracket, respectively, to securely hold 2x4 strongbacks to the form. This provides added strength and alignment to the form.

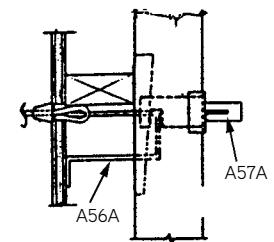
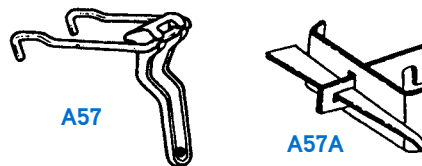

A81 Jahn® “A” Bracket

Dayton Superior’s A81 Jahn “A” Bracket is designed to be used with any standard Dayton Superior short-end snap tie. This durable bracket can be used with horizontal walers or vertical studs.

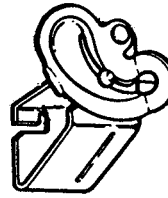

A81 Jahn “A” Bracket

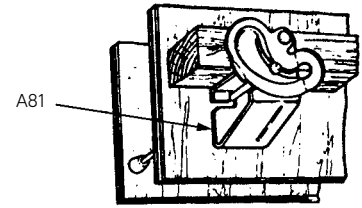

A82 Jahn® “C” Bracket

Dayton Superior’s A82 Jahn “C” Bracket is used to attach vertical strongbacks to the formwork for added strength and alignment.



A82 Jahn “C” Bracket

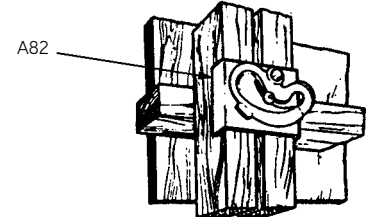

A90 Scaffold Bracket

Dayton Superior’s A90 Scaffold Bracket is used to support scaffolding on nearly any type of formwork. It can be flush mounted or adjusted to fit the various size vertical or horizontal walers or strongbacks. The Scaffold Bracket has a safe working load of approximately 1,000 pounds.

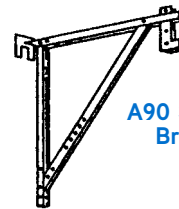

A90 Scaffold Bracket

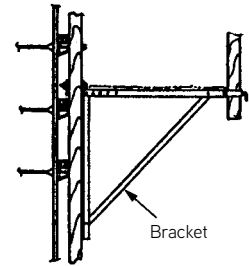

A93 Sure Guard® Rail Post System

The Sure Guard Rail Post System opens wide and tightens quickly, allowing for application to practically any project. The post is easily installed utilizing a top adjusting wing nut which creates the ability to tighten from a standing position. A specially designed base adds to the simplicity of setup with predrilled holes providing trouble-free fastening to decks.

This post can adjust to any floor slab thickness between 4” - 29”. A drop pin makes the Sure Guard Rail Post System simple and efficient to use. The 30 lb. Sure Guard Rail Post System is also hot-dipped galvanized for durability and designed to withstand the toughest jobsite conditions.

* WARNING: Rail Post must be secured to deck with proper fasteners to ensure safety.

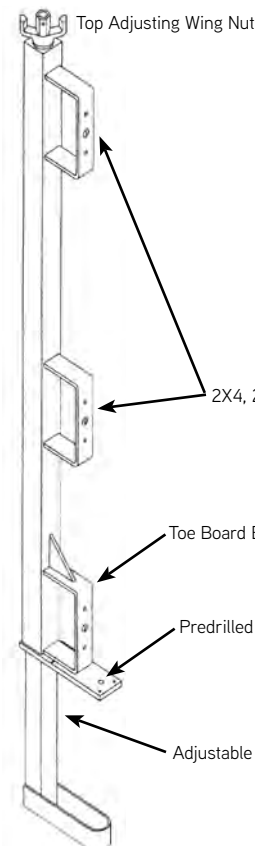

A93 Sure Guard Rail Post System

B1, B2, B3 Coil Tie

Dayton Superior's Coil Ties are strong, resistance welded ties designed for medium and heavy forming applications. Coil tie products are available in two or four struts, with screw-on plastic cones and water-resistant versions. 1/2", 3/4", 1" and 1-1/4" diameters are available.

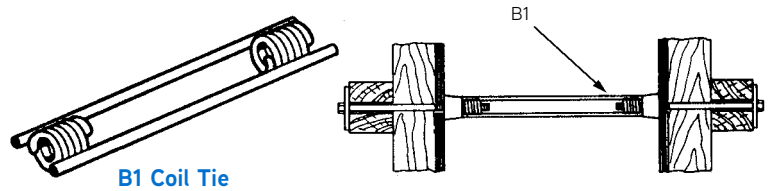

B12 Coil Rod

Dayton Superior's B12 Coil Rod is continuous coil threaded rod available in 1/2" to 1-1/2" diameters in 1/4" increments. Available in special cut-to-length sizes or in standard 12' lengths, Coil Rod and threaded bar are used with other coil tie products in many different combinations and applications. Available with galvanized and stainless steel finishes.

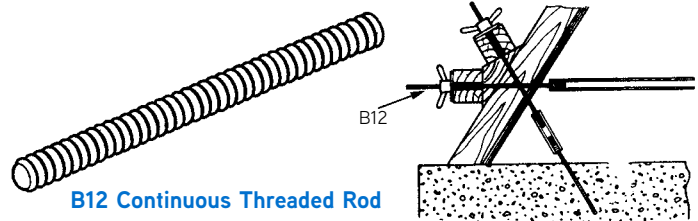

B12A D/R® Thread Bar and B12AD D/R® Euro Thread Bar

D/R Thread Bar is a high strength, 15mm and 20mm ductile steel with a full length, cold-rolled contour thread. The 2-1/2 threads per inch offers fast installation and stripping. D/R Thread Bar is available in 20'-0" standard lengths and can be cut to specific project requirements. Field cutting, with Carborundum blades, is easily accomplished without thread damage.

The D/R Euro Thread Bar is a hot-rolled high strength steel with two flat sides in the thread pattern. This bar has been used in Europe on all types of projects for years. The flat sides provide self-cleaning and allow a gripping surface for turning the bar. Euro Thread Bar is available in 15mm (5/8") and 20mm (7/8") diameters, in standard in 19'-1" lengths. It is bendable and weldable.



B12A D/R Thread Bar

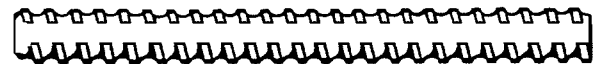

B12-AD D/R Euro Thread Bar

B12ACN Cast Hex Nut and B12ASN D/R® Steel Hex Nut

15mm and 20mm hex nuts, in cast and steel versions, are available with 2-1/2 threads per inch to be used in conjunction with the appropriate D/R Thread Bar.

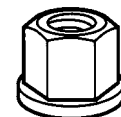

B12-ACN
Cast Hex Nut

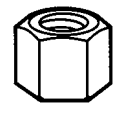

B12ASN
Steel Hex Nut

B12AW D/R® Wing Nut, B12ASW D/R® Swivel Wing Nut, and B12AWN D/R® Cast Nut Washer

15mm, 20mm and 32mm Wing Nut is a high strength malleable steel nut with 2-1/2 threads per inch for use with the D/R Thread Bar. For added versatility, the Swivel Wing Nut features a heavy duty, ribbed washer base, reducing the number of loose working parts required. Made with electro galvanized finish per ASTM B633 SCI Type II.

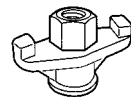

B12AW Wing
Nut

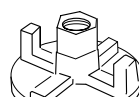

B12AWN D/R
Cast Nut Washer

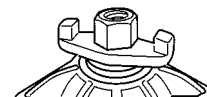

B12ASW
Swivel Wing Nut

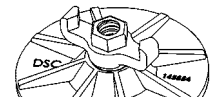

Swivel Wing Nut with a
Round Plate.

B12AC D/R® Hex Coupler

15mm and 20mm Hex Couplers are available to couple two D/R Thread Bars. The Hex Coupler is supplied with 2-1/2 threads per inch and a positive stop. This coupler is weldable.

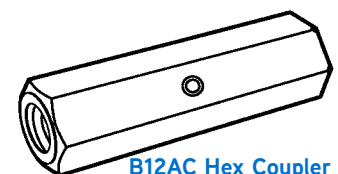

B12AC Hex Coupler

B14 Coil Bolt

Dayton Superior's B14 Coil Bolts are hex head bolts threaded for the contour of the coil tie helical coil. Available in 1/2", 3/4", 1", 1-1/4" and 1-1/2" diameter and length as required in 1" increments.



B14 Coil Bolt

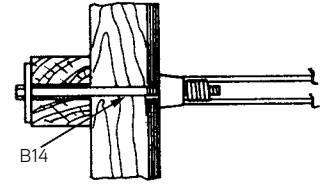

B14A Adjustable Coil Bolt

Dayton Superior's B14A Adjustable Coil Bolt is adaptable for special applications at corners, batter walls, etc., where one-size Adjustable Coil Bolt may replace several different lengths of the standard Coil Bolt.

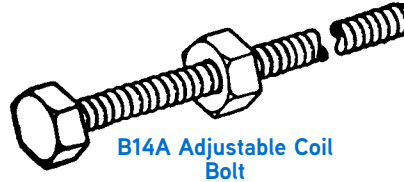

B14A Adjustable Coil Bolt

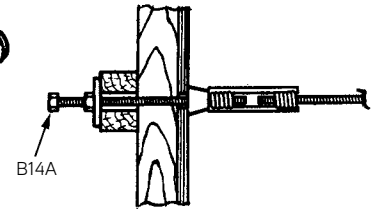

B11 Flat Washer

Dayton Superior's B11 Flat Washers - flat steel plate available in sizes to fit all coil bolt, she-bolt and taper tie applications.

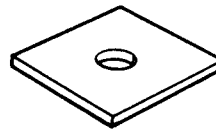

B11 Flat Washer

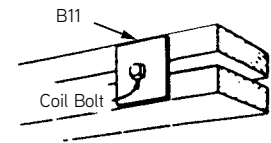

B13 Coil Nut and B32 Handle Coil Nut

Dayton Superior's B13 Coil Nut and B32 Handle Coil Nut are available in 1/2", 5/8", 3/4", 7/8", 1", 1-1/8", 1-1/4" and 1-1/2" diameters with coil thread. The Handle Coil Nut eliminates the need for a wrench and makes installation and stripping fast and simple. B32 is MTO (made to order.)



B13 Coil Nut

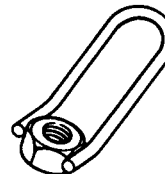

B32 Handle Coil Nut

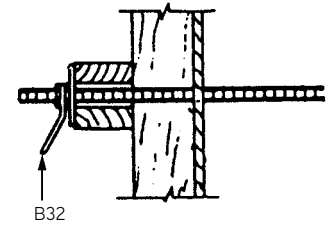

D2, D30 She-Bolt

Dayton Superior's She-Bolts are high strength units suitable for heavy concrete construction. Manufactured with either Acme or Coil external threads, for use with gang and/or steel forms. She-Bolts are used in conjunction with inside tie rods (D1, D18).

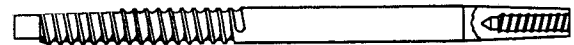

D2 She-Bolt

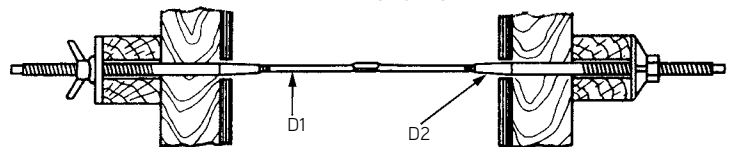

D1, D18 Inside Tie Rod

Dayton Superior's D1 and D18 Inside Tie Rods for She-Bolts are manufactured in three styles; plain, with flats and continuous threaded. Positive stops and/or water-resistant models are available.

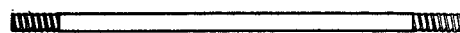

Standard D1



Standard D18

Flat - Location May Vary

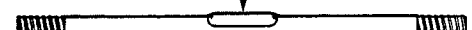

D1 with Flat

D30A Thread Bar She-Bolt

The Dayton Superior D/R Thread Bar She-Bolt is a heavy duty, reusable form ties for medium and heavy concrete construction. Two she-bolts are used with a length of D/R Thread Bar to tie formwork for any wall thickness. D30A She-Bolts are available in 15mm and 20mm diameter. Other sizes available on request.

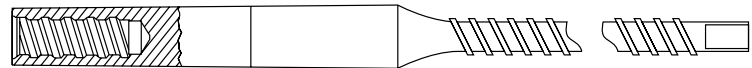

D30A Thread Bar She-Bolt

D9, Taper Tie

Dayton Superior's D9 and Taper Ties are used where specifications permit complete removal of the form tie from the concrete. They are manufactured with coil thread and with up to 90" of taper.

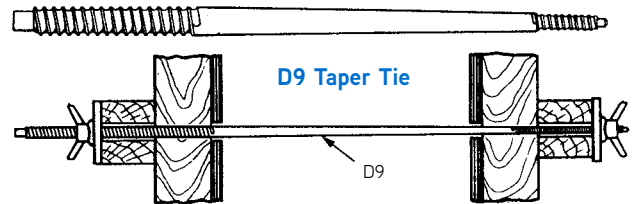

D9 Taper Tie

D9A Thread Bar Taper Tie

Dayton Superior D/R Thread Bar Taper Ties (D9A) are used when specifications require or permit complete removal of the form tie from the concrete. The D9A features the D/R Thread Bar's 2-1/2 threads per inch for rapid installation and stripping. Standard 15mm, 20mm and 32mm diameter taper ties are available in 41", 49", 58" and 66" overall length.

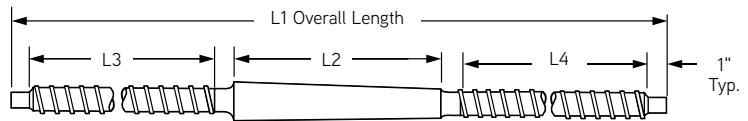

D9A Thread Bar Taper Tie

D40 He-Bolt

He-Bolts are used in conjunction with one of the many form anchorage units to provide an economical method of anchoring cantilever forms.

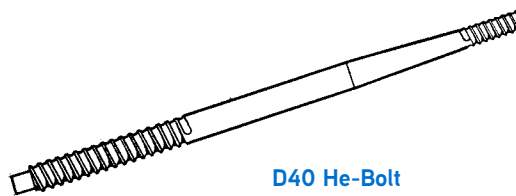

D40 He-Bolt

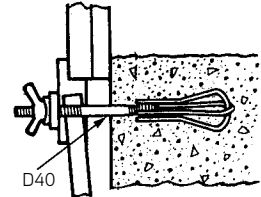

B39 Wing Nut

Dayton Superior's B39 Wing Nuts are available in 1/2" through 1-1/2" diameters. Wing Nuts are normally supplied with coil threads. Acme thread is available on special order. Wing Nuts are typically used with she-bolts, he-bolts, taper ties and through bolting in heavy forming applications.

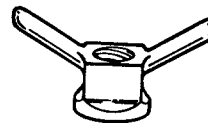

B39 Wing Nut

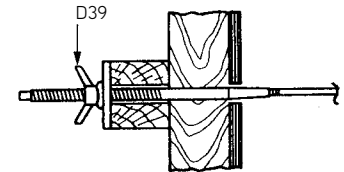

B42, D22 Batter Washer

Dayton Superior's B42 Batter Washers are designed to swing freely to any desired angle up to 45°. They are available in 1/2" through 1-5/8" diameters. Nail holes permit nailing to the waler and multiple grips on the underside help prevent slippage.

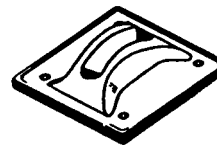

B42 Batter Washer

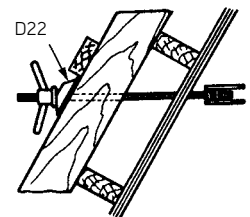

B18, B33, B43 Flared Coil Loop Insert

Dayton Superior's Flared Coil Loop Inserts are used with coil thread bolts to effectively anchor formwork. Available in several configurations with 3/4", 1", 1-1/4" and 1-1/2" diameter coil thread.

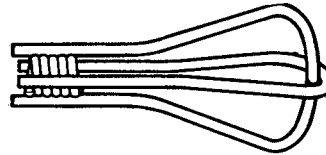

B33 Flared Coil Loop Insert

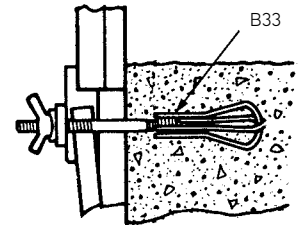

D24 Adjustable Weld Angle Bracket

Dayton Superior's D24 Adjustable Weld Angle Bracket is designed to tie single-sided forming to steel piles, metal beams, etc. The brackets provide 110° of bolt adjustability and are available in 1/2", 5/8", 3/4", 7/8", 1" and 1-1/8" diameter coil thread as well as 15mm and 20mm D/R thread.

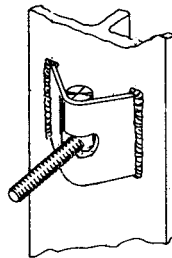

D24 Adjustable Weld Angle Bracket

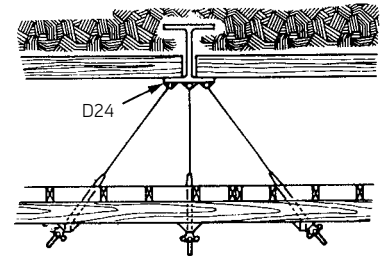

B31 Rock Anchor

Dayton Superior's B31 Rock Anchor is designed for use in sound rock or concrete to secure one-sided forming. Available in 1/2", 3/4" and 1" nominal diameters with coil thread.

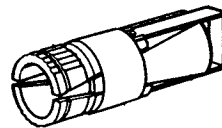

B31 Rock Anchor

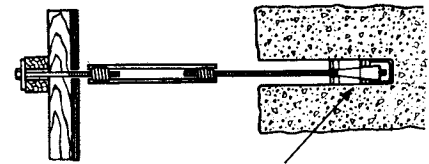

F1 Screw Anchor and F2 Screw Anchor Bolt

Dayton Superior's F1 Screw Anchor is a helical coil used in conjunction with the skein thread F2 Screw Anchor Bolt. Available in 3/4" to 1-1/2" diameters, the screw anchor is very effective supporting cantilever forms and transferring the bolt load into the concrete.

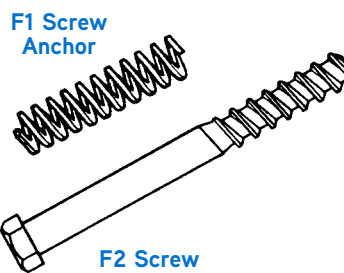

F2 Screw Anchor Bolt

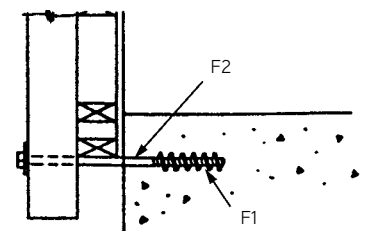

C1B, C1C Wedge Hanger

Dayton Superior's Wedge Hangers are standard snap ties bent to fit over the flanges of a steel beam to support deck formwork. Standard breakback is 1", other breakbacks can be furnished on special order.

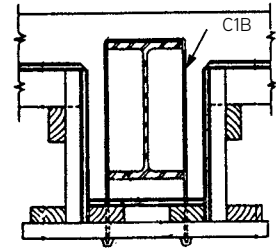
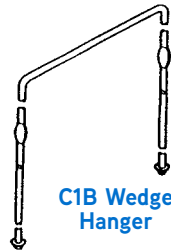

C2 Coil Hanger, Saddle Type

Dayton Superior's C2 Coil Hanger is similar to the Wedge Hanger, above. It utilizes a two strut coil tie to support heavier forming loads.

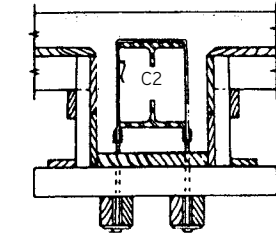
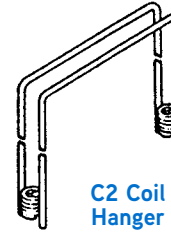

C3 Coil Half Hanger

Dayton Superior's C3 Coil Half Hanger is designed to be welded to an exterior steel beam or bent around an exterior steel beam flange to support double ledgers.

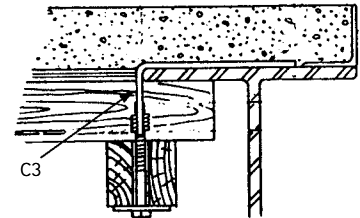
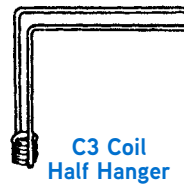

C13 Plate Saddle Hanger

Dayton Superior's C13 Plate Saddle Hanger is placed over a beam to provide support for joists on both sides of the beam. Plate Saddle Hangers can be ordered with any drop and/or beam width to fit the application.

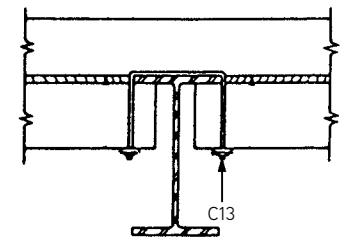
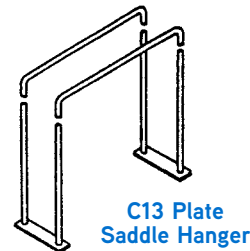

C13A All-Wire Saddle Hanger

Dayton Superior's C13A All-Wire Saddle Hanger is similar in design and function to the C13 above but without the plate.

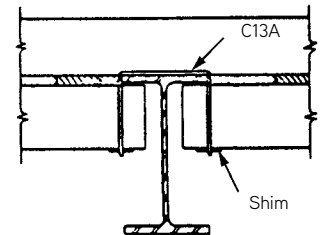

C14 Channel Saddle Hanger

Dayton Superior's C14 Channel Saddle Hanger is similar in design and use as the C13 Hanger above but utilizes channels in place of the plates to reduce crushing of wood joists.

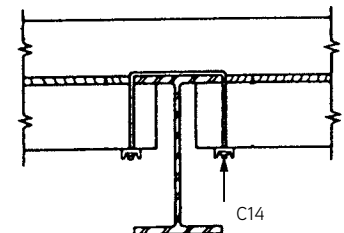
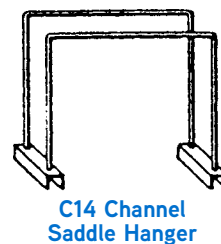

B16, B17, B18, B33 Coil Loop Insert

Dayton Superior's Coil Loop Inserts are made of a single or multiple looped wires welded to a helix coil. They are available in 1/2" to 1" diameters suitable for many concreting applications.

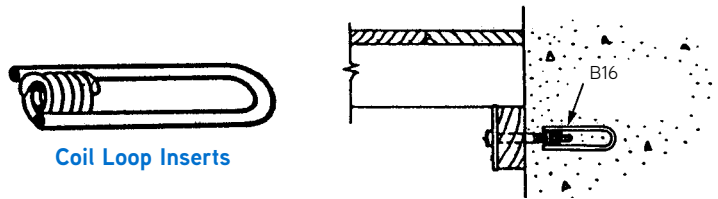

Coil Loop Inserts

F56, F57, F58, F59, F60, F61 Expanded Coil Insert

Dayton Superior's Expanded Coil Inserts are coil or closed ferrule structural connection inserts available in two, four or six strut versions, in 1/2" through 1-1/2" diameters, with or without nailing washer.

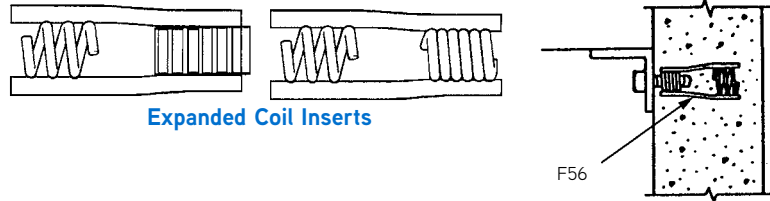

Expanded Coil Inserts

F42 Loop Ferrule Insert

Dayton Superior's F42 Loop Ferrule Insert is a versatile insert suited for structural connections and suspension of equipment, ceilings, piping, etc. Available in 1/4" to 1" diameter closed ferrules in 1/8" increments.

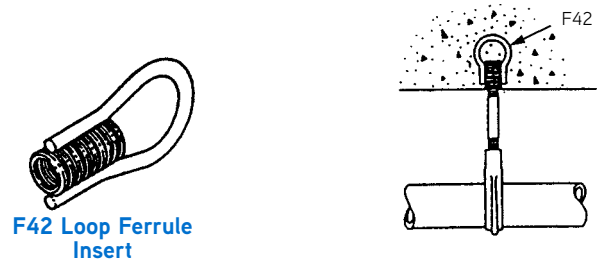

F42 Loop Ferrule Insert

F44 Thin Slab Ferrule Insert

Dayton Superior's F44 Thin Slab Ferrule Insert is used where the depth of embedment is limited. The F44 is specially designed to develop good working loads in very thin concrete slabs. Available in 1/4" through 1" diameter, in 1/8" increments, closed ferrules.

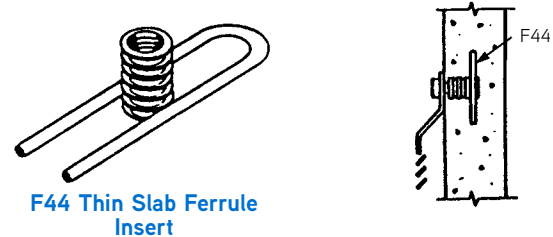

F44 Thin Slab Ferrule Insert

F54 Ductile Embed

Dayton Superior's F54 Ductile Embed is a structural embed available in 5/8" through 1-1/4" diameters and is available in several configurations. This is an integrally forged embed with no welds. It is designed to develop pullout and shear loads exceeding A325 bolt capacities.

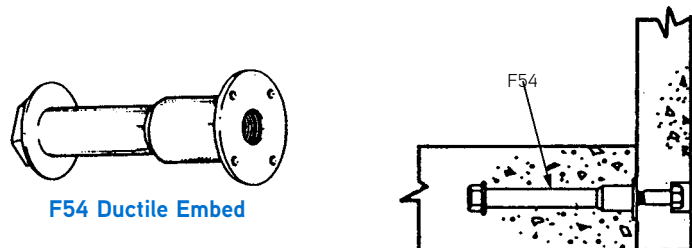

F54 Ductile Embed

D12A Pencil Rod

Dayton Superior's D12A Pencil Rod is available in .225" and .375" mild steel smooth rod for use with the rod clamps shown below. Pencil rod is available in rolls or straightened and cut to length.

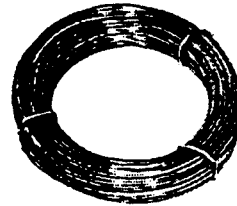

D12A Pencil Rod

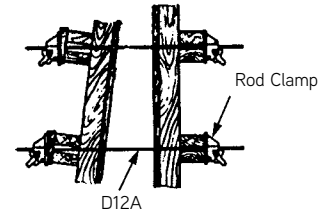

D12 Rod Clamp

Dayton Superior's D12 Rod Clamps are available for use with .1/4" through 3/8" smooth or deformed rod to tie various types of concrete forms. Rod clamps are especially useful on battered and curved wall applications.

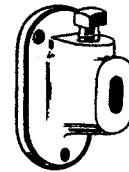

D12 Rod Clamp

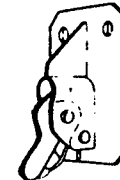

D12F Form Clamp

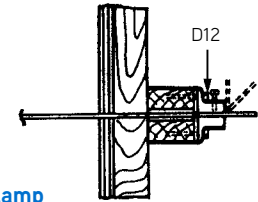

B27 and D6 Nut Washer

Dayton Superior's B27 and D6 Nut Washers are one-piece ductile steel designs combining the washer and nut in a single unit. Nail Holes are provided to secure the washer to the formwork. B27 Nut Washers are furnished with coil thread in 1/2" through 1" diameters for use with any coil thread device. The D6 Nut Washer has 3/4" Acme thread and is used with the D2 She-Bolt.

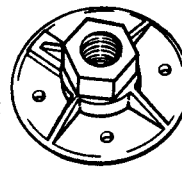

B27 Nut Washer

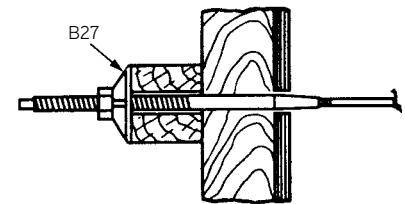

A95 Dayton Bar

Dayton Superior's A95 Dayton Bar is a heavy duty pry bar ideally suited for use by tilt-up erectors to strip forms and to "jockey" a panel into position. The Dayton Bar is available in 3" and 5" blade widths.



A95 Dayton Bar

A100 Speed Step® Bracket

The Dayton Superior A100 SpeedStep Bracket is a reusable bracket designed to simplify layout, set-up and stripping of concrete stair forming. One size fits all standard stairs.

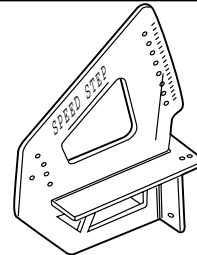

A100 SpeedStep Bracket

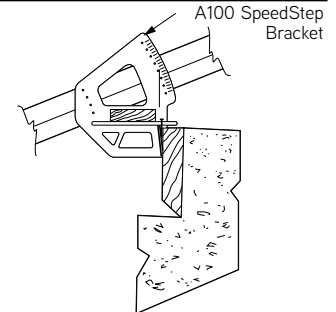

A100 SpeedStep Bracket

PC110 Rebar Safety Caps and D48 Sure-Guard® Rebar Protectors

The patented PC110 meets OSHA requirements. It contains a curved steel plate which provides extra protection in falls that occur from an angle, preventing hazardous impalement.

- Protects workers from protruding rebar
- Impalement protection
- One size fits #3 through #11 rebar
- Safety orange color
- Fully tested and approved (OSHA C-1730)
- Meets Cal OSHA max. drop test requirements
- Complies with Cal OSHA, Section 1712

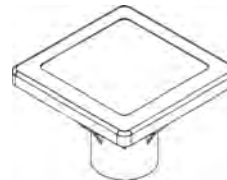

PC110 Rebar Safety Cap



D48 Sure-Guard® Rebar Protector

The D48 Sure-Guard Rebar Protector is a rebar safety cap used to prevent bar end contact in applications where impalement protection is not required.

- Fits size #3 available up to #18
- Safety orange color
- Usable on most jobsites
- Faster product fulfillment times

C60 Pres-Steel Hanger, Type 1

Dayton Superior's C60 Pres-Steel Hanger, Type 1 permits installation and adjustment from above the deck. C60 Pres-Steel Hanger, Type 1 has a nominal 3/8" setback and is used to support deck formwork on interior bridge beams.

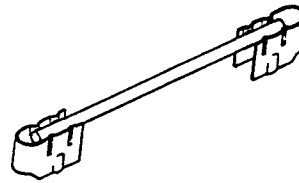

C60 Pres-Steel Hanger, Type 1

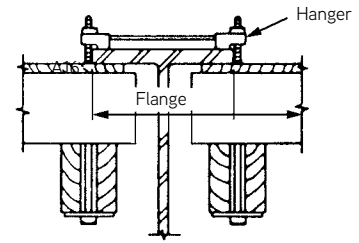

C60 Pres-Steel Hanger, Type 2, Type 3 and Type 7

Dayton Superior's C60 Pres-Steel Hangers, Type 2 and Type 7 are similar to Type 1 hanger, above, except Type 2 and Type 7 hangers provide for 1" to 2-1/2" haunch conditions, respectively.

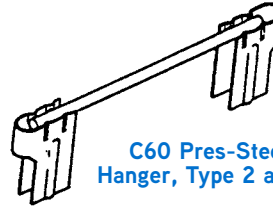

C60 Pres-Steel Hanger, Type 2 and 7

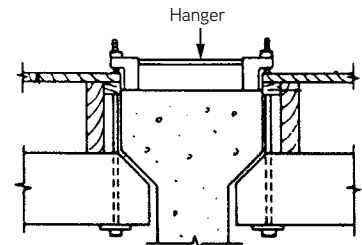

C60 Pres-Steel Hanger, Type 4

Dayton Superior's C60 Pres-Steel Hangers, Type 4 are used on steel interior bridge beams to support deck formwork. The hanger's end sections extend over the edge of the beam to resist shifting.

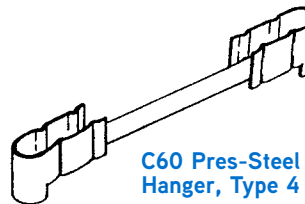

C60 Pres-Steel Hanger, Type 4

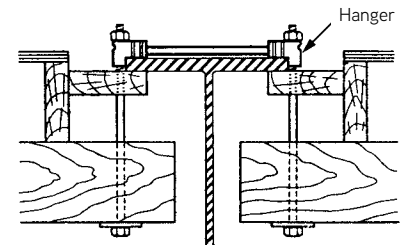

C24 Pres-Steel Half Hanger

Dayton Superior's C24 Pres-Steel Half Hangers are designed to be field welded to a steel bridge beam or to bridge beam rebar stirrups and provide one-sided forming support.

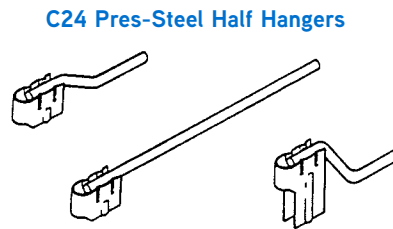

C24 Pres-Steel Half Hangers

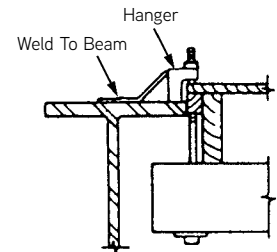

C25 Adjustable Half Hanger

Dayton Superior's C25 Adjustable Half Hanger attaches to a bridge beam stirrup and is designed to support one-sided forming on applications where welding is not an option.



C25 Adjustable Half Hanger

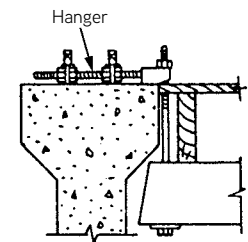

C41 Coil Rod Hanger

Dayton Superior's C41 Coil Rod Hanger is designed to support interior forming on both sides of a bridge beam and to breakback inside the concrete. The C41 Coil Rod Hanger can be used effectively with any haunch height condition.

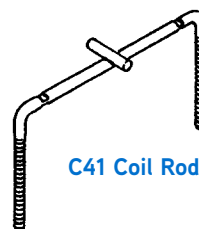

C41 Coil Rod Hanger

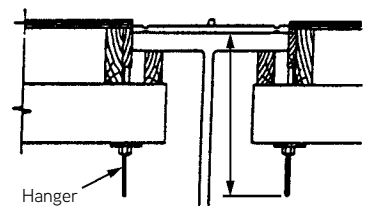

C60 Pres-Steel Hanger, Type 1-A

Dayton Superior's C60 Pres-Steel Hanger, Type 1-A is designed with a 45° end section at one end and is used to support fascia overhang formwork.

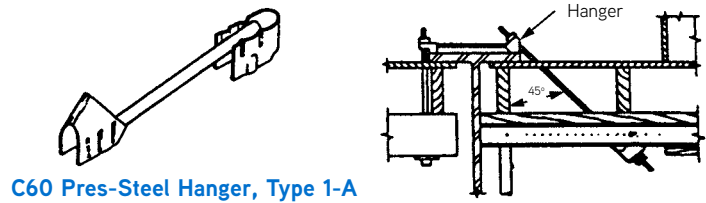

C60 Pres-Steel Hanger, Type 1-A

C62 45° Pres-Steel Hanger

Dayton Superior's C62 Pres-Steel Hanger is designed with a 45° end section at one end and is used to support fascia overhang formwork. Haunch heights up to 2-3/4" can be accommodated.

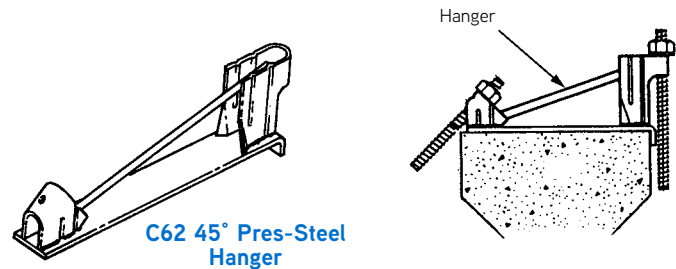

C62 45° Pres-Steel Hanger

C60 45° Pres-Steel Hanger, Type 4-A and Type 5-A

Dayton Superior's C60 Pres-Steel Hangers, Type 4-A and Type 5-A are designed with a 45° end section at one end to support fascia overhang formwork. The 90° end section extends over the edge of the bridge beam for added support and resistance to shifting.

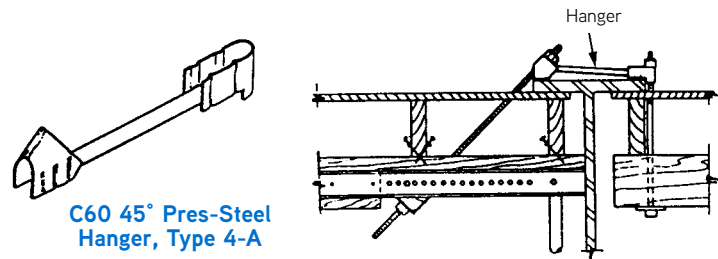

C60 45° Pres-Steel Hanger, Type 4-A

C24 45° Pres-Steel Half Hanger

Dayton Superior's C24 45° Pres-Steel Half Hanger is designed to be field welded to a steel beam or to concrete beam rebar stirrups to provide one-sided forming support.

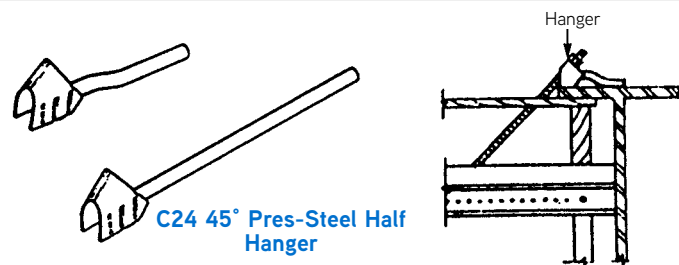

C24 45° Pres-Steel Half Hanger

C25 45° Adjustable Half Hanger, Type 1-A

Dayton Superior's C25 45° Adjustable Half Hanger, Type 1-A attaches to a bridge beam rebar stirrup to support one-sided forming applications where welding is not an option.

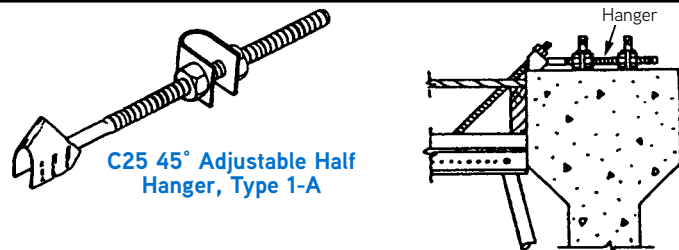

C25 45° Adjustable Half Hanger, Type 1-A

C41 45° Coil Rod Hanger, Type 1-A

Dayton Superior's C41 45° Coil Rod Hanger, Type 1-A is designed to support interior forming on one side of a bridge beam and fascia forming on the other. The C41 45° Coil Rod Hanger, Type 1-A can be used effectively with any haunch height condition and can be broken back inside the concrete.

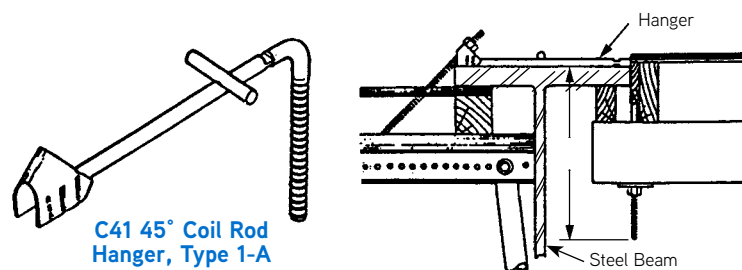

C41 45° Coil Rod Hanger, Type 1-A

C49 Bridge Overhang Bracket

Dayton Superior's C49 Bridge Overhang Bracket supports bridge deck fascia formwork. It can be mounted to steel or concrete girders using an appropriate hanging device.

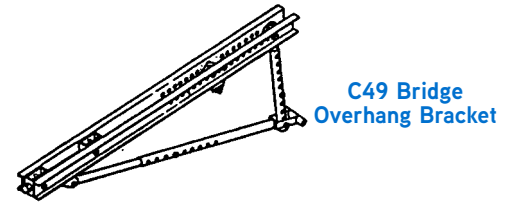

C49 Bridge Overhang Bracket

C49D Bridge Overhang Bracket For Deep Girders

Dayton Superior's C49D Bridge Overhang Bracket for deep girders supports bridge deck fascia formwork. It has been designed to mount to deep steel or concrete girders, using an appropriate hanging device.

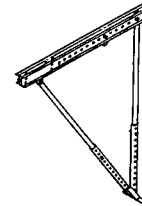

C49D Deep Overhang Bracket

C49W Bridge Overhang Bracket

Dayton Superior's C49W Bracket aids in preventing web of beam from bending during construction of bridge deck. Constructed with all-steel support frame to improve stability and resist movement. Meets ANSI Specification A 10.9, Sections 6.5.1, 6.6.1, 7.2.1 and ACI 347 Specification 2.4 Screw Jacks extend up to 6".

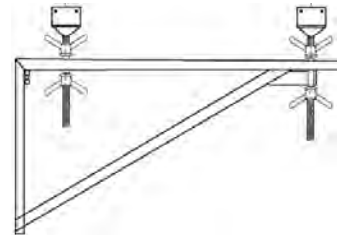

C49W Bridge Overhang Bracket

C89 Heavy Duty Bridge Overhang Bracket

Dayton Superior's C89 Heavy Duty Bridge Overhang Bracket supports bridge deck fascia formwork. The bracket, available in 72" or 90" versions, can be utilized on steel or concrete girders using the appropriate 3/4" hanging device.

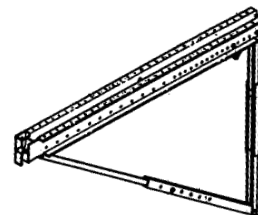

C89 Heavy Duty Bridge Overhang Bracket

C52P Guard Rail Speed Bracket Assembly

The C52P Guardrail Speed Bracket Assembly is designed for fast and easy attachment to the C49 Bridge Overhang Bracket. The C52P's Speed Bracket bolts securely to the C49 Bridge Overhang Bracket and provides a base to simply install the Guardrail Post. The Guardrail Post has a nail down feature to prevent uplift. The C52P is compatible with lumber or cable railings. The Guardrail Assembly weighs a convenient 15.6 lbs.

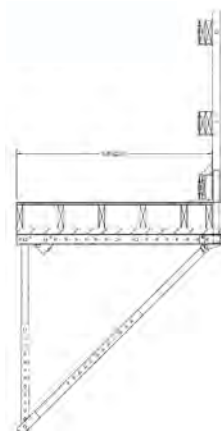

C52P Guardrail Speed Bracket Assembly

D101A, D102A, D103A and D104A Dowel Bar

Dayton Superior's D101A through D104A DBSAE Splicers are one-piece forged units made from grade 60 rebar and are supplied with NC or UNC threads depending on size. Splicers are available in bar sizes #4 through #11 in straight, hooked, double-ended and bolt-headed configurations.



Dowel Bar

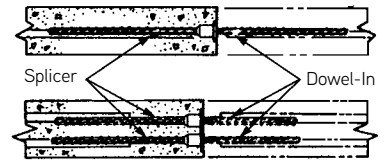

D101, D102, D103 and D104 Dowel-In

Dayton Superior's D101 through D104 Dowel-Ins are manufactured from grade 60 rebar material and are available in sizes #4 through #11 for use with the DBSAE Splicer shown above. Dowel-Ins are available in straight, 90° hooked, 180° hooked and double-ended configurations.

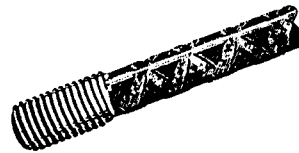

Dowel-In

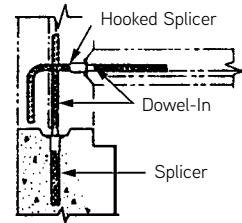

D158 End Anchor

Dayton Superior's D158 End Anchors are available in all rebar sizes and in various configurations to aid in situations where rebar congestion or other difficult concreting conditions restrict placement of hooked rebar or long lap splices.

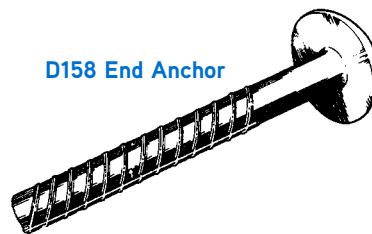

D158 End Anchor

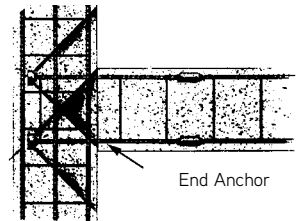

End Anchor

D250 Bar Lock® Couplers

Dayton Superior's D250 Bar Lock Couplers provide a simple, quick, cost effective method for splicing rebar in tension and/or compression. Bar Lock Couplers are available for use with smooth or deformed bars in sizes #4 through #18.

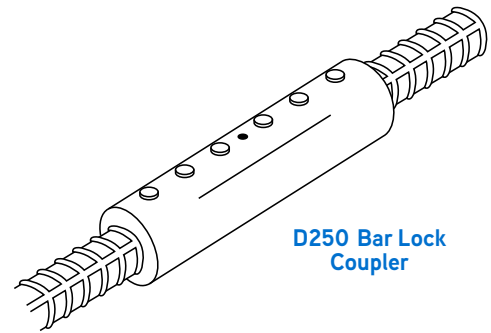

Taper-Lock®

Dayton Superior is proud to offer the portable, high-speed taper cut solution! Turn the system that has already been proven on sites throughout Europe into your on-site advantage. Dayton Superior is the only company able to bring the reliable Taper-Lock design to North American fabricators and contractors.

Taper-Lock's portable design allows you to take the system wherever you need it. Its revolutionary high-speed taper cut more than doubles the production of conventional cutters, allowing you to beat deadlines. The system uses conventional water-soluble cutting fluid. The strong unit withstands tough projects. Its straightforward process makes operation and repair easy.



D410 Sleeve-Lock® Grout Sleeve

The Dayton Superior D410 Sleeve-Lock Grout Sleeve is a one-piece mechanical coupler designed to butt-splice reinforcing steel in concrete structures. The Grout Sleeve is available in seven (7) sizes to accommodate deformed bar sizes #4 through #18. Bars of like size or of different sizes can be effectively spliced by the System. Typical sleeve applications include precast and cast-in-place concrete structures.

The D410 Sleeve-Lock Grout Sleeve is a ductile casting with a minimum yield strength of 55,000 psi and a minimum tensile strength of 80,000 psi. It exceeds all known building codes and agency standards. The System achieves a full type 2 grade 60 splice, meeting the 160% f_y strength criteria with the Dayton Superior Sleeve-Lock Grout D490, a high strength, non-shrink grout.

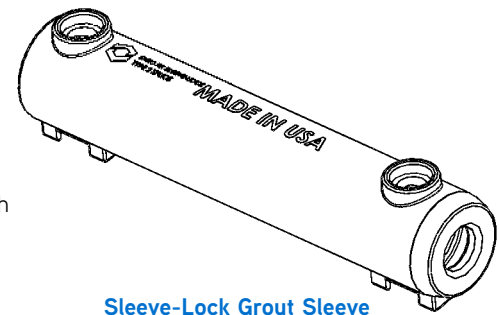

Slab Bolster

Dayton Superior's Slab Bolster is used to support lower slab steel from the slab form. Legs are spaced on 5" centers. Available in 3/4" to 3" heights in 5' lengths and in bright basic, galvanized, plastic protected, epoxy coated or stainless steel protected.

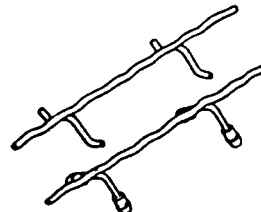

Slab Bolster

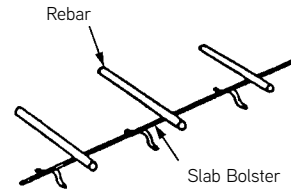

Rebar
Slab Bolster

Beam Bolster

Dayton Superior's Beam Bolster is used to support lower beam steel from the soffit form. Legs are spaced on 2-1/2" centers. Available in 1-1/2" to 5" heights in 5' lengths. Manufactured in bright basic, plastic protected, epoxy coated, galvanized or stainless steel protected.

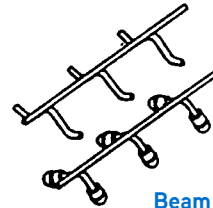

Beam Bolster

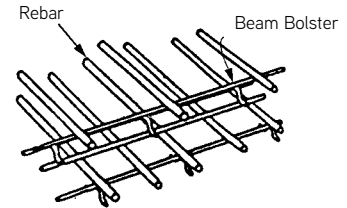

Rebar
Beam Bolster

Continuous High Chair

Dayton Superior's Continuous High Chair provides support for upper slab steel eliminating the need for carrier bars. Fabricated in 2" to 15" heights in 5' lengths with legs spaced on 7-1/2" centers. Available in bright basic, plastic protected, epoxy coated, galvanized and stainless steel protected.

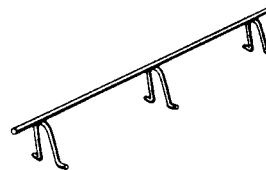

Continuous High Chair

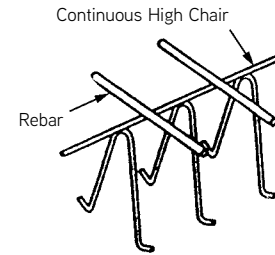

Continuous High Chair
Rebar

Individual High Chair

Dayton Superior's Individual High Chair is used to support upper steel directly or by means of a carrier bar. Available in 2" to 15" heights in bright basic, plastic protected, epoxy coated, galvanized and stainless steel protected.

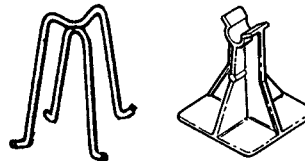

Individual High Chair

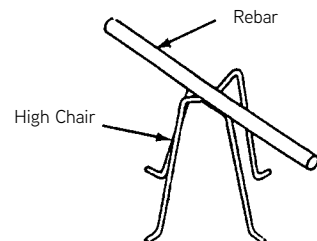

High Chair
Rebar

Bar Chair

Dayton Superior's Bar Chair is used to support wide spaced light steel in slab construction. Available in 3/4" to 2" heights in bright basic, plastic protected, epoxy coated, galvanized and stainless steel protected.



Bar Chair

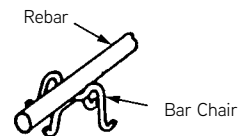

Rebar
Bar Chair

Joist Chair

Dayton Superior's Joist Chair is used to support two bottom bars in the ribs of joist or grid type slabs. Available in 4", 5" and 6" overall widths; 3/4", 1" and 1-1/2" heights; and in bright basic, plastic protected, epoxy coated, galvanized and stainless steel protected.



Joist Chair

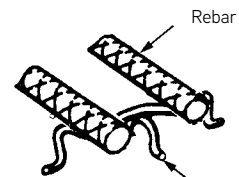

Rebar
Joist Chair

Aztec® E-Z Chair® – PEZ*

The Aztec E-Z Chair is the most popular on the market. It features Standard “Concrete Gray” color (custom colors available-inquire), minimal surface contact and is designed for maximum aggregate flow and concrete consolidation. It provides high load capacity, fits up to #8 rebar, but does not straddle the bottom rebar mat in double mat applications (for straddle applications, see Aztec Tower Chair).

Applications: Single Mat -Rebar or Wire Mesh, Bottom Layer Double Mat Rebar or Wire Mesh, Tilt-Wall, Side-Form Spacer, On-Grade: when used with Sand Plate

Cover Height: From 3/4" to 6" (1/4" increments).

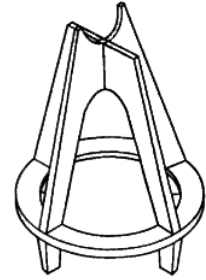

E-Z Chair (PEZ)

Aztec® EZ Set Chair™ – PEZS*

The Aztec EZ Set Chair supports an upper reinforcement mat with the ability to straddle lower reinforcement mats

Applications: Single Mat -Rebar or Wire Mesh, Bottom Layer Double Mat-Rebar or Wire Mesh, Tilt-Wall, Side-Form Spacer, On-Grade: when used with Sand Plate.

Cover Height: From 2.75" to 14" (1/4" increments)

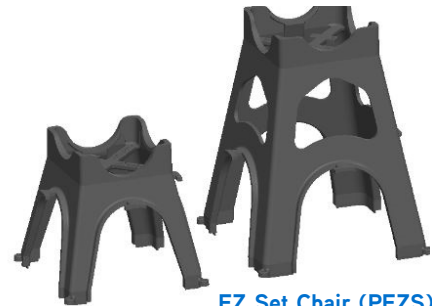

EZ Set Chair (PEZS)

Aztec® Castle Chair – PCC*

The Aztec Castle Chair is the most stable on-grade chair available. It features a heavy-duty, smooth bottom, stackable design, ideal for use on insulating foam or vapor barriers. It fits up to #8 rebar and supports 500 lbs. + loads. Each chair comes in two height combinations reducing inventory.

Application: On-Grade, Single Mat - Rebar or Wire Mesh, Bottom Layer Double Mat-Rebar or Wire Mesh, Precast/Tilt-Wall, Insulated “Sandwich” Panels.

Cover Height: From 1-1/2" to 6-1/4" (1/4" increments)

Castle Chair Round Base 1-1/2" to 4-1/4" tall, Castle Chair Square Base 4-1/2" to 6-1/4" tall.

*Meets all requirements and qualifies as a CRSI Class 1 Bar Support.



Castle Chair (PCC)
Square Base

Castle Chair (PCC)
Round Base

Snap-On Paving Chair (#3, #4)

Plastic, snap-on paving chairs are available for #3 and #4 Rebar. They are manufactured in 1" through 6" heights and are also available with a square base.

Snap-On Paving Chair (#4, #5, #6)

Plastic, snap-on paving chairs are available for #4, #5, and #6 Rebar. They are manufactured in 1" through 7" heights and are also available with a square base.

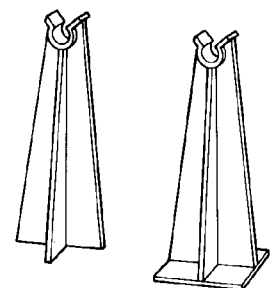

Snap-On Paving Chairs

Aztec® StrongBack Slab / Beam Bolster – PSBB*

The Aztec StrongBack Slab / Beam Bolster is high load strength and impact resistant, it qualifies for use as a Beam Bolster with 2-1/2" leg spacing, and can be used individually or locked together to create any length. The Strongback Slab is manufactured in 30" lengths in standard boxes. Special packaging available in 5' or 10' sections, bundled and palletized.

Application: Elevated Slab, Tilt Wall, Precast, Post-Tension, Parking Garage Decks, Side-Form Spacer

Cover Height: From 3/4" to 3" (1/4" Increments)

Meets all requirements and qualifies as a CRSI Class 1 Bar Support.



StrongBack Slab Beam Bolster (PSBB)

Aztec® StrongBack SBU Slab Bolster Upper – PSBU*

The Aztec StrongBack Slab Bolster Upper is designed for use with Epoxy-Coated/FRP/ Stainless Steel/Galvanized rebar and is intended for use in corrosive environments, it is as strong as metal SBU. The Strong Back Slab Bolster Upper spans corrugations in elevated deck applications, is suitable for use on Vapor Barriers or Insulating Foam, no overlap required, manufactured in 30" lengths in standard boxes. special packaging available in 5' or 10' sections, bundled and palletized.

Application: Supports top layer in Double Mat application, Rebar or Wire Mesh, Slabs, Heavy Duty On-Grade, Corrugated Decking, Side-Form Spacer-below-grade applications only, Precast

Cover Height: From 1" to 3-1/4" (1/4" increments)

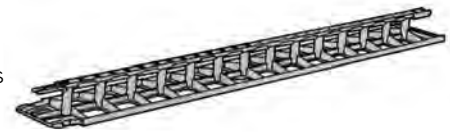

StrongBack SBU Slab Bolster Upper (PSBU)

Continuous Mesh Support

Continuous mesh supports are manufactured in 5' 0" lengths and 3", 4", 5", 6", and 7" heights.

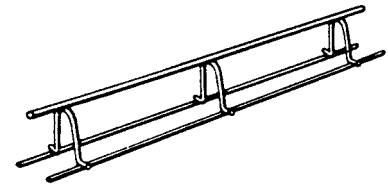

Continuous Mesh Support

Continuous High Chair Upper (CHCU)

These continuous supports are available in 2" through 25" heights. They are fabricated in Bright Basic Wire (CHCU-3) or Epoxy-coated Wire. Per 100 Ft. or Per 100 Pcs.

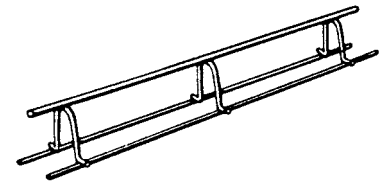

Continuous High Chair Upper (CHCU)

Continuous Support

A continuous metal bar support used to maintain the elevation of rebar in reinforced concrete. Continuous supports are available for wire mesh support in 2" through 16" heights in 1/2" increments. .

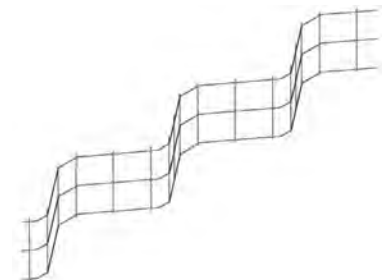

Continuous Support

T41 Ground Release Lifting Insert

Dayton Superior's T41 Ground Release Lifting Insert is a 4 ton insert designed to accommodate the T43R Lifting Hardware shown below. The insert is complete with plastic void and wire or plastic protected base.

T41 Ground Release Lifting Insert



T43L Ground Release Lifting Hardware

Dayton Superior's T43L Ground Release Lifting Hardware is designed to lift and place tilt-up wall panels quickly and efficiently. The unit offers high safe working loads, ease of operation and a positive ground release.

T43L Ground Release Lifting Hardware



T49 Gyro Tilt Plus® Insert

Dayton Superior's T49 Gyro Tilt Plus Insert is a 4 ton insert designed to accommodate the T50 Gyro Tilt Plus Hardware shown below. The insert is complete with plastic void and plastic protected wire base.

T49 Gyro Tilt Plus Insert

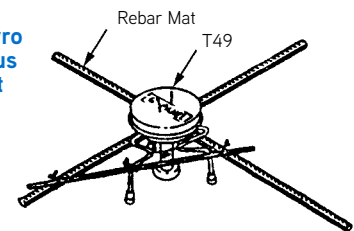
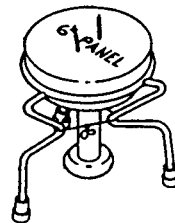

T50 Gyro Tilt Plus® Hardware

Dayton Superior's T50 Gyro Tilt Plus Hardware is designed to lift and place tilt-up wall panels quickly and efficiently. The system is easy to use, quick and has a positive ground release.



T50 Gyro Tilt Plus Hardware

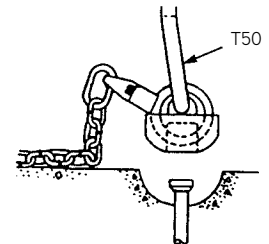

T110H (Gen 2) Superior Lift System

The Dayton Superior T110H (Gen 2) Superior Lift Insert consists of a forged foot anchor, plastic leave-in void former, and plastic base. The insert is positioned with the void direction to the top of the panel and then is tied in place to the rebar cage. The T120 Superior Lifting Hardware allows quick attachment to the insert and remote ground release after the panel has been erected and braced. The T110H Superior Lift Inserts are shipped assembled and ready to go.

T110H (Gen 2) Superior Lift System



T275 Tilt-Up Anchor

The Dayton Superior T275 Tilt-Up Anchor consists of a dual forged foot anchor assembled with a plastic recess plug and two plastic supports. The insert is a directional insert used parallel to the height of the panel. The T275 inserts are shipped assembled, ready to install and sized to the panel thickness. It is installed in concrete tilt-up panels and used for lifting applications.

T275 Tilt-Up Anchor



T120 Superior Lift Hardware

The Dayton Superior T120 Superior Lift Hardware is designed to easily attach to the insert by engaging the curved clutch handle into the opening in the anchor. The ball of the hardware is designed to readily align itself to the pull of the rigging. Once engaged and under load, it can not be disengaged by remote ground release until the load has been removed in lowering the rigging. The T120 is used for both face and edge lift system conditions.



Wall Brace

Dayton Superior's Wall Braces are all steel, heavy duty wall braces designed to quickly and easily align and brace tilt-up wall panels. Wall braces are available in several models that span brace lengths of 5'-0" to 62'-0" with ultimate load rating 2,025 to 36,000 lbs.

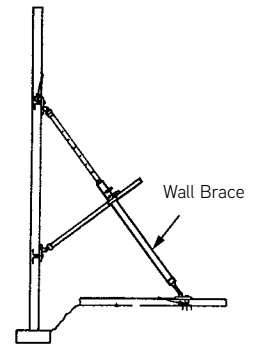

Brace Insert

Dayton Superior's Brace Inserts are available in several versions. They are designed to be cast-in-place in the concrete panel and used to anchor tilt-up wall braces during the construction sequence.

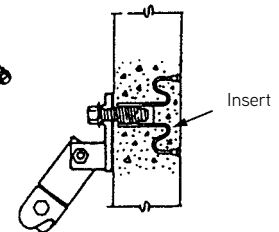
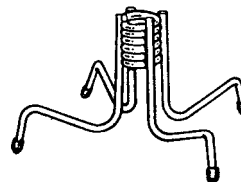

Wall Brace Inserts

T6B Brace Anchor

Dayton Superior's T6B Brace Anchors are 3/4" diameter coil inserts that are designed to easily position and tie into the rebar mats of the tilt-up panel. Comes with a pre-installed bolt for quick and easy installation.



T6B Brace Anchor

T28 Superior Plate Dowel System

Dayton Superior's The Superior Plate Dowel System is comprised of two components that consist of a plastic sleeve and a steel plate. These components are used together to provide stability at the concrete joint by allowing the positive transfer of load to offer a smooth slab-to-slab transition.



T28 Superior Plate Dowel

T13 Coil Anchor

Dayton Superior's T13 Coil Anchor is a drill-in anchor designed for use in the floor slabs of tilt-up buildings to attach and anchor wall braces during panel erection or to secure emergency lift plates.



T13 Coil Anchor

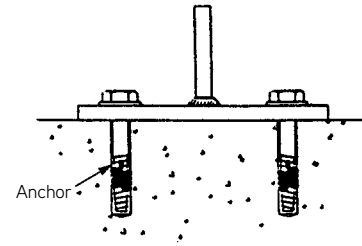

Bearcat™ Bolt Multi-Use

The Dayton Superior Bearcat™ Bolt Multi-Use is a high strength, reusable drill-in screw anchor. This anchor utilizes a pre-drilled hole and self-taps into the concrete, creating a mechanical connection between the concrete and the anchor threads.

Designed specifically for tilt-up construction applications and the high strength carbon steel allows for multiple reuses. The yellow electro-galvanized zinc coating keeps the anchor from corroding between and during uses.



Bearcat Bolt Multi-Use

Bearcat™ Bolt Single-Use

The Dayton Superior Bearcat™ Bolt Single-Use is a high-strength drill-in screw anchor designed specifically for use in tilt-up construction applications.

The Single-Use Bearcat utilizes a pre-drilled hole and then self-taps into concrete to create a mechanical connection between the concrete and the anchor threads. This one-time-use bolt is available in a blue electro galvanized zinc finish to prevent rust and corrosion.



Bearcat Bolt Single-Use

T12 and T26 Swivel Lift Plate

Dayton Superior's T12 and T26 Swivel Lift Plates are designed for use with 3/4" through 1-1/2" lifting bolts to attach to coil lift inserts cast in a tilt-up wall panel.

T12



T26

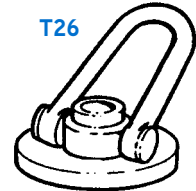

T8 Lifting Angle, T27 Edge Lifting Plate

Dayton Superior's T8 Lifting Angle and T27 Edge Lifting Plate are designed for use with 3/4" or 1" tandem lifting inserts to lift and position tilt-up panels.

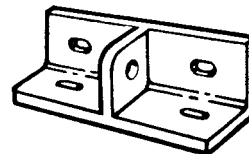

T8 Lifting Angle

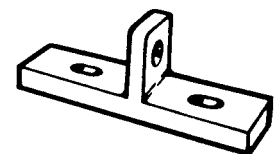

T27 Edge Lifting Plate

Helical Ground Anchors

The Helical Ground Anchor (HGA) is part of a total bracing system designed for rapid installation and the ability to immediately load the helical ground anchor for unsurpassed speed and efficiency on any tilt-up or pre-cast project.



Helical Ground Anchor (HGA)

HGA Extension

Certain sites where the foundation soils are lower strength may require the use of an HGA Extension. This shaft is the same section (1½" square bar) but is 4' in length and has a 10" helical plate set at 10" from the top of the extension.



HGA Extension

Transition Brace Connector

The Transition Brace Connector (TBA) connects the brace to the HGA. It leads to quicker installation and better alignment of the brace center-line to the HGA center-line.



T14 Pipe Brace

T24 Adjustable STBC Connector

The Adjustable STBC Connector features 3 hole adjustments and offers quicker installation and better alignment of brace to HGA without removing the foot plate from the brace.

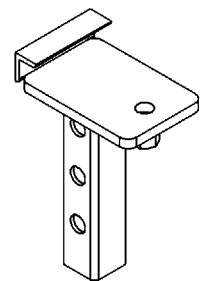

T24 Adjustable STBC Connector Extension

Twin STBC Connector

The Twin STBC Connector quickly connects the braces to the HGA. Twin STBC Safe Working Load is a total of 15,000 lbs. with 2:1 Safety Factor (*Safe Working Load per side is 7,500 lbs*)



Twin STBC Connector

P50 Swift Lift® Universal Lifting Eye and P51 Swift Lift® Lifting Eye

Swift Lift lifting eyes are used with the Swift Lift anchors shown below to strip, transport and erect precast concrete elements. The P50 units are available in 1, 2, 4, 8 and 20-ton safe working load capacities. The P51 units are available in 2T, 4T and 8T units only.

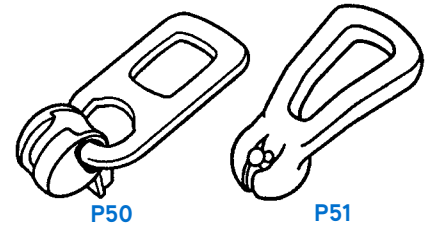

P52 Swift Lift® Anchor and P53 Swift Lift® Eye Anchor

Swift Lift anchors may be used with either of the above Swift Lift lifting eyes. Swift Lift anchors are available in various lengths and capacities to meet the requirements and needs of the precast industry.

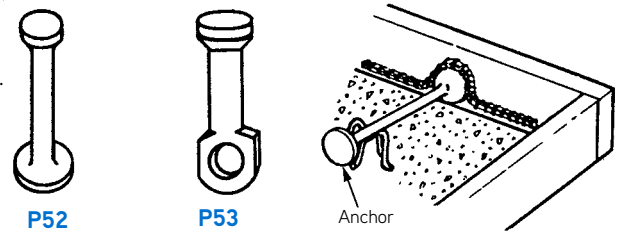

P56PL Swift Lift® Recess Plug and P69M Swift Lift® Magnetic Setting Plate

Use Swift Lift Recess Plugs to securely hold Swift Lift anchors in place during placement of the concrete. The plugs also form a void around the anchor's head, which allows for easy attachment of the lifting hardware.

The P69M Magnetic Setting Plate offers the precaster a fast and secure method of attaching Swift Lift anchors to the side or bottom of steel forms.

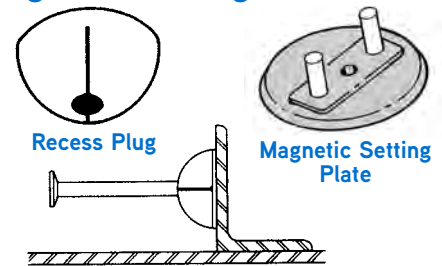

P91S and P91NC Fleet-Lift™ Hardware

Dayton Superior's Fleet-Lift Hardware is used with Fleet-Lift Anchors to face-lift or edge-lift precast concrete elements. Units are designed to connect and disconnect quickly and to rotate for easy alignment.

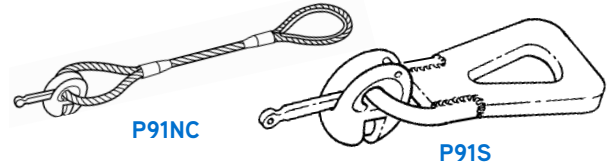

Fleet-Lift Anchors

Fleet-Lift anchors are available in 1, 2, 3, 4, 6, 8, 10, and 12-ton capacities and are used with the above hardware to strip, transport and erect precast concrete elements.

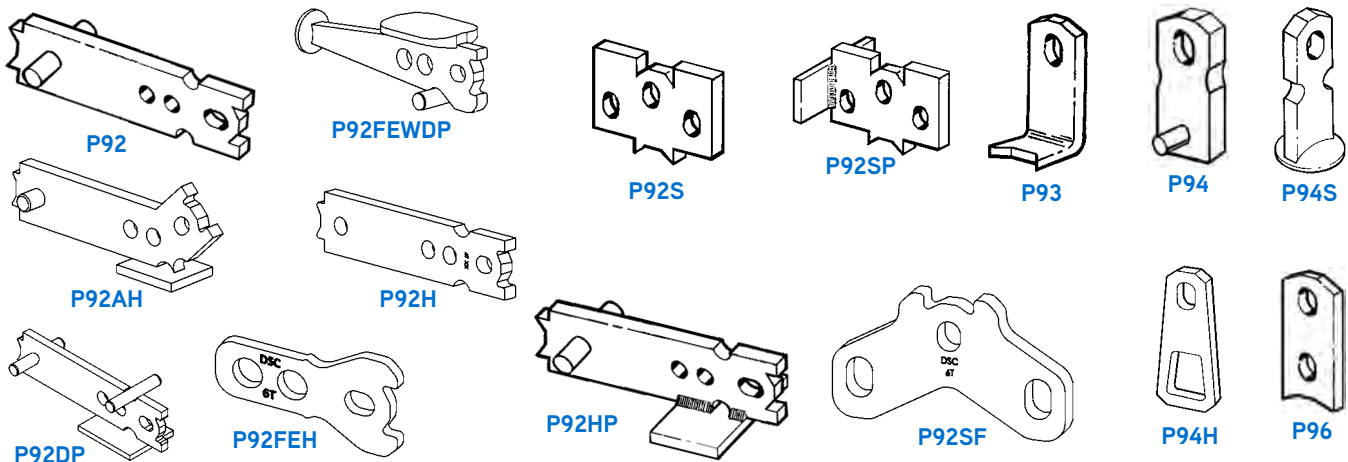

P92FE and P92FEW Fleet-Lift Forged Erection Anchors

The Fleet-Lift Forged Erection Anchor is specifically designed to provide greater lifting capacities for horizontal to vertical edge lifts. They are available in 3T, 6T and 10T SWLs. The anchors are forged to provide 20% greater safe working loads. This anchor utilizes the Fleet-Lift lifting hardware and the P99 Recess Plugs. Available in plain or hot-dipped galvanized finishes.



P99 Fleet-Lift™ Recess Plug and P100M Fleet-Lift™ Magnetic Plate

Fleet-Lift Recess Plugs are designed to hold Fleet-Lift anchors securely in place during the placement of the concrete. They also form a void around the anchor head, which allows for easy attachment of the lifting hardware.

A fast and secure method of attaching Fleet-Lift anchors to steel forms is available with the P100-M Magnetic Plate.

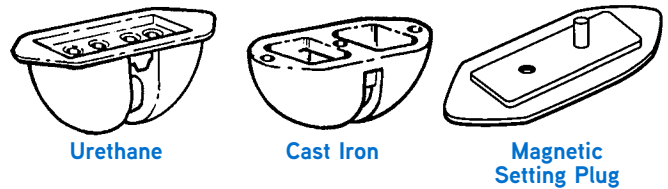

P75 Utility Anchor, P75H Utility Anchor Heavy, P76 Utility Anchor Setting Plug

The Dayton Superior Utility Anchors are designed to economically simplify the stripping, transporting and installation of underground or other types of utility precast concrete elements. As special lifting hardware is not required for use with these utility anchors, they offer not only economic advantages, but versatility and ease of use.

The P75 units are available in several safe working load capacities, up to 10,000 lbs SWL in tension. The P75H anchor has a safe working load of 24,000 lbs in tension.

Reusable setting plugs, used with either 3/8" coil threaded rods or setting plates, are available to set anchors in place in the forms.

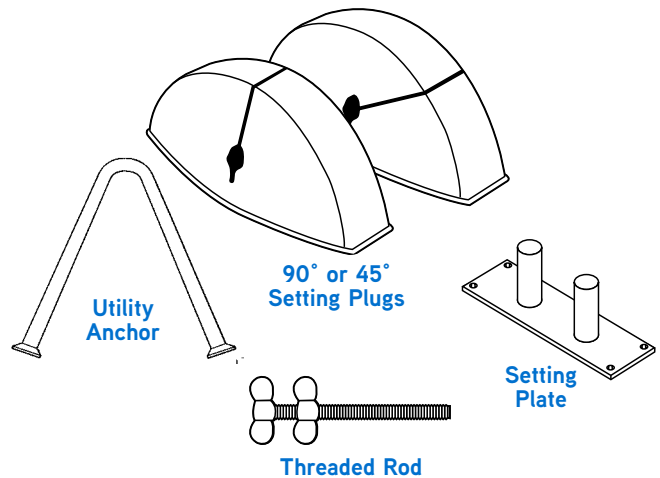

P76D and P76P Disposable Void Former

The Dayton Superior P76D 7.5 T Disposable Void Former was created to allow a large enough void to utilize Crosby Hooks for lifting precast products. The 7.5T Disposable Void Former is a 2 part recess plug fabricated from high density polyethylene plastic. The two-piece design snaps together around the head of the anchor to securely grasp the anchor. The tight fit eliminates the concrete entering into the void. The design secures the anchor in proper position and maintains 1/2" clearance between top edge of the anchor and the top surface of the concrete. The tabs on the ends of the void former provide a convenient method to nail the assemble to a form. The Void Former is removed and discarded after usage.



P80 / P81 Superior Shimpak

Dayton Superior’s shimming material is an engineered multipolymer plastic which provides an optimum combination of physical properties for a shim in applications where high compressive strength and load bearing is important. It facilitates the placement of architectural members.

Popular sizes are 4" x 6" and 4" x 4" paks which are 1-1/16" thick. Shimpaks are made up of shims in the following thickness sequence; one 1/16th, three 1/4ths and two 1/8ths.

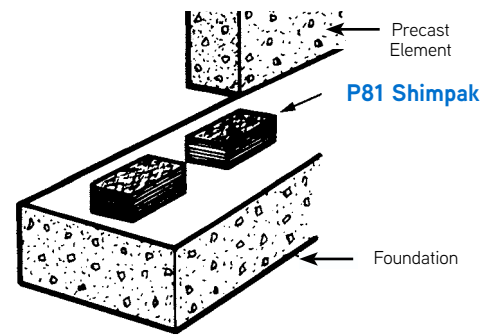

P24 Delta Tie Insulated Concrete Panel Tie

Dayton Superior offers a unique composite panel tie for use in connecting the exterior and interior wythes of precast concrete insulated “sandwich” panels. The use of the P24 Delta Tie offers quick and easy tie installation resulting in stiffer panels, increased load bearing and material, labor and transportation cost savings.

Larger P24XL also available.

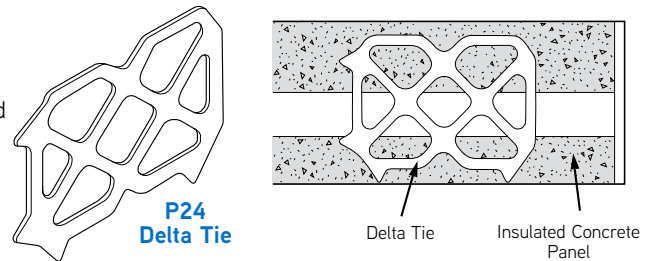

P38 Corewall® Slotted Insert II

The Corewall Slotted Insert II is the next generation product in the Corewall legacy. The design has been updated to create a higher load capacity and greater ease of installation. With six different product options and two different finishes, the Corewall Slotted Insert II will meet any application. This Product is an addition to the Corewall Slotted Inserts which have been specified and used by precasters for over 20 years. The existing styles of Corewall Inserts remain available.



Corewall Insert

Formliner and Rustication

Over 120 formliner patterns are available in several different materials and thicknesses, each providing a distinct surface treatment. Dayton Superior’s rustications are available in various shapes, materials and sizes to meet the needs of the precaster.

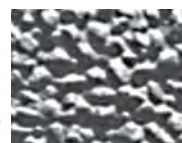

Formliner

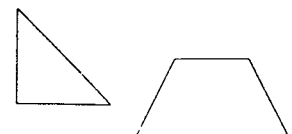

Rustications

P27 Yeti-Anchor®

The P27 Yeti-Anchor® is a high performance, non-conductive, non-corrosive continuous glass-fiber reinforced polymer anchor used as a wythe connector for concrete insulated sandwich panel construction.

The Yeti-Anchor is offered for 1.5" (YS) and 2" (YL) concrete embedment and insulation thicknesses of 2" - 4" (see size chart for more information). Additional insulation thicknesses can be offered upon request. The Yeti-Anchor was tested in accordance with ICC-ES AC320, Acceptance Criteria for Fiber-Reinforced Composite Anchors in Concrete. The Yeti also has a 4-hour ASTM E-119 fire rating and passed the NFPA 285 fire testing.



P27 Yeti-Anchor



Prestress Strand Restraint Devices

Dayton Superior's has a large comprehensive line of prestress strand "hold down" units that have been thoroughly tested and broadly accepted as the Standard of the Precast/Prestressed Concrete Industry. They are fabricated without welds, using only positive mechanical connections between the various components of each device.

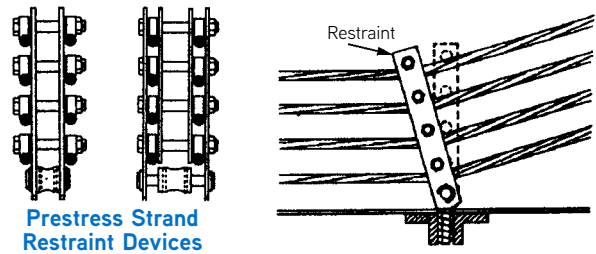

P12G Welded Wire Girder

Welded Wire Girder is used as a shear connection for insulated sandwich panels. Welded Wire Girder not only connects the concrete widths through the insulation material, but has the resiliency to expand and contract with the independent thermal-induced movement of the outer width. Available in plain or hot dip galvanized finishes.



P12 Dur-O-Web® Shear™ Reinforcement

Dur-O-Web is a prefabricated structural web reinforcement assembly that replaces conventional stirrups in prestressed tees. It allows the spacing of the smooth, round vertical and horizontal wires to vary, meeting various design requirements.

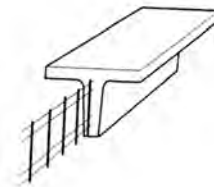

Steel Forms for Precast

Dayton Superior's offers precasters in various types and sizes of steel forms as may be required. For medium barriers, utility poles, pile forms, girder forms and double tee forms.

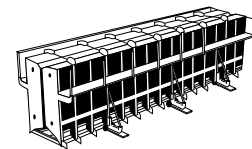

Magnets

Dayton Superior offers a complete line of integrated magnetic components designed to help save time and money in precast forming applications. The Dayton Superior Magnetic Precast Forming System includes On/Off Magnets, Loaf Magnet, Button Magnets, Chamfer and Reveals, Embedment and Insert Magnets, Manhole Step Magnets and Custom Magnets for any application.

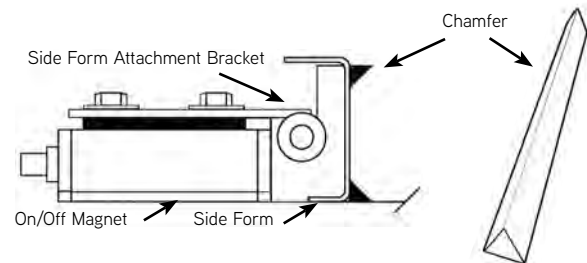

Paragon Test Cylinders

Application: Test cylinders are used in every application where concrete is used. They are used to test and monitor concrete strength in those applications where minimum strength is required.

Features

- Reinforced lip and bottom
- Concrete gray color (4"x8" size has yellow option available)

Sizes: 2"x4", 3"x6", 4"x8", 6"x12"



Test Cylinder

Paragon Hole Covers

Application: Hole-in-one covers adjust to fit various sizes holes in on-grade applications

Features

- Prevents accidents and injuries
- Beveled edges prevent tipping hazards
- No sawing, pre-drilling, or bolting into concrete necessary
- Reusable
- Hardware includes

Sizes: 15" round, 7" round, 15"x15" square, 8"x15" rectangle



Hole Covers



Paragon Intersectional Chairs

Application: Designed to support 3/8" or 1/2" diameter strand in post-tension applications

Features

- Holds cables from both directions
- Tips hold chairs securely in place
- On-grade Paragon products come in various colors

Sizes: 1.5" through 5" in 1/2" increments



Intersectional Chairs

Paragon Mesh Chairs

Application: Used for supporting reinforcement bar in tilt-up panels

Features

- Designed for optimal aggregate flow
- Minimal footprint does not show after panel is erected
- High-strength plastic
- Dual height
- Concrete gray

Sizes: 1.5" through 5" in 1/2" increment



Mesh Chair

Paragon Tilt-Up Chairs

Application: Used for supporting reinforcement bar in tilt-up panels

Features

- Designed for optimal aggregate flow
- Minimal footprint does not show after panel is erected
- High-strength plastic
- Dual height
- Concrete gray

Sizes: Various options ranging from 3/4" through 5-3/4"



Tilt-Up Chairs

Paragon Precast Wire Chairs

Application: Supports wire mesh in precast applications

Features

- Supports wire mesh
- Minimal footprint and concrete gray color make it excellent for architectural concrete
- Open design allows for maximum aggregate flow

Sizes: 1-1/2" & 2"



Precast Wire Chairs

Paragon Centralizers

Application: Centralizers are designed to ensure a central location of rebar in a column form and intended for drilled shafts and piling applications

Features

- Made from lightweight, durable plastic that will not rust or corrode
- Thin profile slips through grout with ease
- Engineered for #7-#11 reinforcing bar with 1/4" off center variance

Sizes: 11" and 15" diameters



Centralizer

Paragon Hog Slat Chair

Application: Hog Slat Chairs hold two reinforcing bars to provide proper placement of rebar in hog slat forms.

Features

- Manufactured from non-corrosive material
- Securely holds rebar in place
- Holds 2 pieces of rebar

Sizes: 3/8" x 1/2" x 3/4", 3/8" x 1/2" x 1", 3/8" x 3/8" x 1"

***first value denotes the bar size that snaps into the top of chair, second value denotes the bar size that snaps into the middle, and the third value denotes the distance between the middle bar and the bottom of the chair*



Hog Slat Chairs

A2	2	Bridge Overhang Bracket	14	D102A	15
A3	2	Bridge Overhang Bracket For Deep Girders.	14	D103	15
A4	2	C1B.....	9	D103A.....	15
A16.....	2	C1C.....	9	D104	15
A21.....	2	C2.....	9	D104A	15
A27.....	2	C3.....	9	D158.....	15
A46.....	3	C13.....	9	D250	16
A48.....	3	C13A	9	D410	16
A55.....	3	C14.....	9	Dayton Bar.....	11
A56.....	3	C24.....	12	Delta Tie Insulated Concrete Panel Tie	26
A56A	3	C24 45°	13	Disposable Void Former	25
A57.....	3	C25.....	12	Dowel-In.....	15
A57A	3	C25 45°	13	D/R Cast Nut Washer.....	5
A81.....	4	C41.....	12	D/R Euro Thread Bar.....	5
A82.....	4	C41 45°	13	D/R Hex Coupler	5
A90.....	4	C49.....	14	D/R Steel Hex Nut.....	5
A93.....	4	C49D	14	D/R Swivel Wing Nut	5
A95.....	11	C49W	14	D/R Thread Bar	5
A100	11	C52P.....	14	D/R Wing Nut	5
Adjustable Coil Bolt	6	C60.....	12, 13	Ductile Embed.....	10
Adjustable Half Hanger.....	12, 13	C60 45°	13	Dur-O-Web® Shear™ Reinforcement.....	27
Adjustable STBC Connector	23	C62 45°	13	Edge Lifting Plate.....	22
Adjustable Weld Angle Bracket.....	8	C89	14	End Anchor	15
Aztec	18	Cast Hex Nut	5	Expanded Coil Insert	10
B1.....	5	Castle Chair	18	E-Z Chair.....	18
B2.....	5	Centralizers (Paragon).....	29	E-Z Set Chair	18
B3.....	5	Channel Saddle Hanger	9	F1.....	8
B11.....	6	CCHCU	19	F2.....	8
B12.....	5	Coil Anchor	22	F42	10
B12A.....	5	Coil Bolt	6	F44	10
B12AC.....	5	Coil Half Hanger.....	9	F54	10
B12ACN.....	5	Coil Hanger, Saddle Type	9	Fabric Stake.....	30
B12AD	5	Coil Loop Insert.....	10	Flared Coil Loop Insert.....	8
B12ASN.....	5	Coil Nut.....	6	Flat Tie	2
B12ASW	5	Coil Rod.....	5	Flat Washer.....	6
B12AW.....	5	Coil Rod Hanger	12, 13	Fleet-Lift Anchors.....	24
B12AWN.....	5	Coil Tie.....	5	Fleet-Lift Forged Erection Anchor	25
B13.....	6	Continuous Bar Support	19	Fleet-Lift Hardware.....	24
B14.....	6	Continuous High Chair	17	Fleet-Lift Magnetic Plate.....	25
B14A.....	6	Continuous High Chair Upper	19	Fleet-Lift Recess Plug.....	25
B18.....	8	Continuous Mesh Support.....	19	Form Anchorage.....	8
B27.....	11	Continuous Support	19	Form Hanger	9
B31.....	8	Corewall Slotted Insert II	26	Formliner	26
B32.....	6	D1.....	6	Gang Loop Panel Tie.....	3
B33.....	8	D2.....	6	Ground Release Lifting Hardware.....	20
B39.....	7	D6.....	11	Ground Release Lifting Insert	20
B42.....	7	D9.....	7	Grout Retention Ring.....	32
B43.....	8	D9A.....	7	Guard Rail Speed Bracket Assembly.....	14
Bar Chair.....	17, 18	D12.....	11	Gyro Tilt Plus Hardware	20
Bar Lock Couplers.....	16	D12A.....	11	Gyro Tilt Plus Insert	20
Bar Support — Metal.....	17	D18.....	6	Handle Coil Nut	6
Bar Support — Plastic.....	18	D22.....	7	Heavy Duty Bridge Overhang Bracket.....	14
Batter Washer	7	D24.....	8	Heavy Forming Accessories	5
Beam Bolster.....	17	D30.....	6	He-Bolt.....	7
Bearcat Bolt, Single Use	22	D30A.....	7	Helical Ground Anchors.....	23
Bearcat Bolt, Multi Use.....	22	D40.....	7	HGA	23
Brace Insert	21	D48.....	11	HGA Extension.....	23
Brace Anchor	21	D101.....	15	Individual High Chair	17
Bracing Products.....	23	D101A	15	Inserts	10
Bridge Deck Forming.....	12	D102	15	Inside Tie Rod.....	6

Ground Release Lifting Hardware.....	20	P92SP.....	24	Swift Lift Magnetic Setting Plate.....	24
Ground Release Lifting Insert.....	20	P93.....	24	Swift Lift Recess Plug.....	24
Grout Retention Ring.....	32	P94.....	24	Swift Lift Universal Lifting Eye.....	24
Guard Rail Speed Bracket Assembly.....	14	P94H.....	24	Swivel Lift Plate.....	22
Gyro Tilt Plus Hardware.....	20	P94S.....	24	T8.....	22
Gyro Tilt Plus Insert.....	20	P96.....	24	T12.....	22
Handle Coil Nut.....	6	P99.....	25	T13.....	21
Heavy Duty Bridge Overhang Bracket.....	14	P100M.....	25	T24.....	23
Heavy Forming Accessories.....	5	PC110.....	11	T26.....	22
He-Bolt.....	7	PCC.....	18	T27.....	22
Helical Ground Anchors.....	23	Paragon Products.....	28-29	T28.....	21
HGA.....	23	Pencil Rod.....	11	T41.....	20
HGA Extension.....	23	PEZ.....	18	T43L.....	20
Hog Slat Chair (Paragon).....	29	PEZS.....	18	T49.....	20
Hole Covers (Paragon).....	28	Plastic Cone Snap Tie.....	2	T50.....	20
Individual High Chair.....	17	Plate Saddle Hanger.....	9	T110H.....	20
Inserts.....	10	Precast Products.....	24	T120.....	21
Inside Tie Rod.....	6	Precast Wire Chairs.....	29	T275.....	20
Intersectional Chairs (Paragon).....	28	Pres-Steel Half Hanger.....	12, 13	T6B.....	21
Jahn "A" Bracket.....	4	Pres-Steel Hanger.....	12, 13	Taper-Lock.....	16
Jahn "C" Bracket.....	4	Prestress Strand Restraint Devices.....	27	Taper Tie.....	7
Joist Chair.....	17	PSBB.....	19	TBA.....	33
Lifting Angle.....	22	PSBU.....	19	Test Cylinders (Paragon).....	28
Light Forming Accessories.....	2	PSC.....	18	Thin Slab Ferrule Insert.....	10
Loop Ferrule Insert.....	10	Rebar Safety Caps.....	11	Thread Bar She-Bolt.....	7
Loop Panel Tie.....	3	Rebar Splicing.....	15	Thread Bar Taper Tie.....	7
Magnets.....	27	Rock Anchor.....	8	Tilt-Up Anchor.....	20
Mesh Chairs (Paragon).....	28	Rod Clamp.....	11	Tilt-Up Chairs (Paragon).....	29
Nut Washer.....	11	Rustication.....	26	Tilt-Up Products.....	20
Omni Wedge.....	2	Saddle Hanger.....	9	Transition Brace Connector.....	23
P12.....	27	Safety.....	1	Transverse Bar Assembly.....	33
P12G.....	27	Scaffold Bracket.....	4	Turnbuckle Form Aligner.....	2
P24.....	26	Screw Anchor.....	8	Twin STBC.....	23
P27.....	26	Screw Anchor Bolt.....	8	Utility Anchor.....	25
P38.....	26	She-Bolt.....	6	Utility Anchor Heavy.....	25
P50.....	24	Slab Bolster.....	17	Utility Anchor Setting Plug.....	25
P51.....	24	Sleeve-Lock Grout Sleeve.....	16	Wall Brace.....	21
P52.....	24	Snap-On Chair.....	18	Wedge Hanger.....	9
P53.....	24	Snap-On Power Chair.....	18	Wing Nut.....	7
P56PL.....	24	Snap Tie.....	2	Yeti-Anchor.....	26
P69M.....	24	Speed Step Bracket.....	11		
P75.....	25	Speedy Bracket.....	3		
P75H.....	25	Splicer.....	15		
P76.....	25	STBC.....	23		
P76D 7.5 T.....	25	Steel Forms for Precast.....	27		
P80.....	26	Stiffback Bracket.....	3		
P81.....	26	StrongBack SBU Slab Bolster Upper.....	19		
P91NC.....	24	StrongBack Slab / Beam Bolster.....	19		
P91S.....	24	Superior Lift Hardware.....	21		
P92.....	24	Superior Lift System.....	20		
P92AH.....	24	Superior Plate Dowel.....	21		
P92DP.....	24	Superior Shimpak.....	26		
P92FE.....	25	Sure Guard Rail Post System.....	4		
P92FEH.....	24	Sure-Lock Bracket.....	3		
P92FEW.....	25	Sure-Lock Strongback Clamp.....	3		
P92FEWDP.....	24	Sure-Lock Tie.....	3		
P92H.....	24	Sure-Snap Hex Head Tie.....	2		
P92HP.....	24	Swift Lift Anchor.....	24		
P92S.....	24	Swift Lift Eye Anchor.....	24		
P92SF.....	24	Swift Lift Lifting Eye.....	24		

	<div data-bbox="662 260 1333 352"> WARNING</div> <p data-bbox="618 380 1382 453">Improper Use of Concrete Accessories Can Cause Severe Injury or Death</p> <p data-bbox="581 464 1419 596">Read, understand and follow the information and instructions in this publication before using any of the Dayton Superior concrete accessories displayed herein. When in doubt about the proper use or installation of any Dayton Superior concrete accessory, immediately contact the nearest Dayton Superior Service Center or Technical Service Department for clarification. See back cover for your nearest location.</p>
---	--

Dayton Superior products are intended for use by trained, qualified and experienced workers only. Misuse or lack of supervision and/or inspection can contribute to serious accidents or deaths. Any application other than those shown in this publication should be carefully tested before use. The user of Dayton Superior products must evaluate the product application, determine the safe working load and control all field conditions to prevent applications of loads in excess of a product's safe working load. Safety factors shown in this publication are approximate minimum values. The data used to develop safe working loads for products displayed in this publication are a combination of actual testing and/or other industry sources. Recommended safe working loads given for the products in this publication must never be exceeded.

Worn Working Parts

For safety, concrete accessories must be properly used and maintained. Concrete accessories shown in this publication may be subject to wear, overloading, corrosion, deformation, intentional alteration and other factors that may affect the device's performance. All reusable accessories must be inspected regularly by the user to determine if they may be used at the rated safe working load or should be removed from service. The frequency of inspections depends upon factors such as (but not limited to) the amount of use, period of service and environment. It is the responsibility of the user to schedule accessory hardware inspections for wear and remove the hardware from service when wear is noted.

Shop or Field Modification

Welding can compromise a product's safe working load value and cause hazardous situations. Knowledge of materials, heat treating and welding procedures is necessary for proper welding. Consult a local welding supply dealer for assistance in determining required welding procedures. Since Dayton Superior cannot control workmanship or conditions in which modifications are done, Dayton Superior cannot be responsible for any product altered in the field.

Interchangeability

Many concrete accessory products that Dayton Superior manufactures are designed as part of a system. Dayton Superior strongly discourages efforts to interchange products supplied by other manufacturers with components supplied by Dayton Superior. When used properly, and in accordance with published instructions, Dayton Superior products have proven to be among the best designed and safest in the industry. Used improperly or with incompatible components supplied by other manufacturers, Dayton Superior products or systems may be rendered unsafe.

Installation

WARNING

1. Dayton Superior Corporation products shall be installed and used only as indicated on the Dayton Superior Corporation installation guidelines and training materials.
2. Dayton Superior Corporation products must never be used for a purpose other than the purpose for which they were designed or in a manner that exceeds specific load ratings.
3. All instructions are to be completely followed to ensure proper and safe installation and performance.
4. Any improper misuse, misapplication, installation, or other failure to follow Dayton Superior Corporation's instruction may cause product malfunction, property damage, serious bodily injury and death.

THE CUSTOMER IS RESPONSIBLE FOR THE FOLLOWING:

1. Conformance to all governing codes
2. Use of appropriate industry standard hardware
3. The integrity of structures to which the products are attached, including their capability to safely accept the loads imposed, as evaluated by a qualified engineer.

SAFETY INSTRUCTIONS:

All governing codes and regulations and those required by the job site must be observed. Always use appropriate safety equipment

Design Changes

Dayton Superior reserves the right to change product designs, rated loads and product dimensions at any time without prior notice.

Note: See Safety Notes and Safety Factor Information.



DAYTON[®]
SUPERIOR

1125 Byers Road
Miamisburg, OH 45342
937-866-0711
888-977-9600

**BUILDING
STRENGTH™**

DS15

Print Revised 04/22

Copyright © 2016 Dayton Superior Corporation, All Rights Reserved.