



**THE
POWER
OF RED™**

SYM-PLY®

CONCRETE
FORMING
SYSTEM

APPLICATION GUIDE



SYMONS®
BY DAYTON SUPERIOR



Basic Equipment	2
Form Alignment and Attachments	8
Clamps	9
Sym-Ply Gang Assembly.....	10
Stacking Panels with Stacking Clamps	11
Stacking Panels with Sym-Walers	38
Corner and Bulkhead Details.....	57
Corner and Column Details	58
Typical Details	60
Non-Perpendicular Corners	61
Taper Ties and She-Bolts.....	61
Top Tie Bracket.....	62
Bulkheads.....	63
60" Sym-Waler	64
Stacking Clamp	64
Job-Built Fillers	64
Slip Plate (3" to 12" Fill Range)	65
Lift Bracket.....	66
Walkway Bracket.....	67
Aligning Formwork	68
Columns	69
Other Tying Considerations	70
Index.....	71

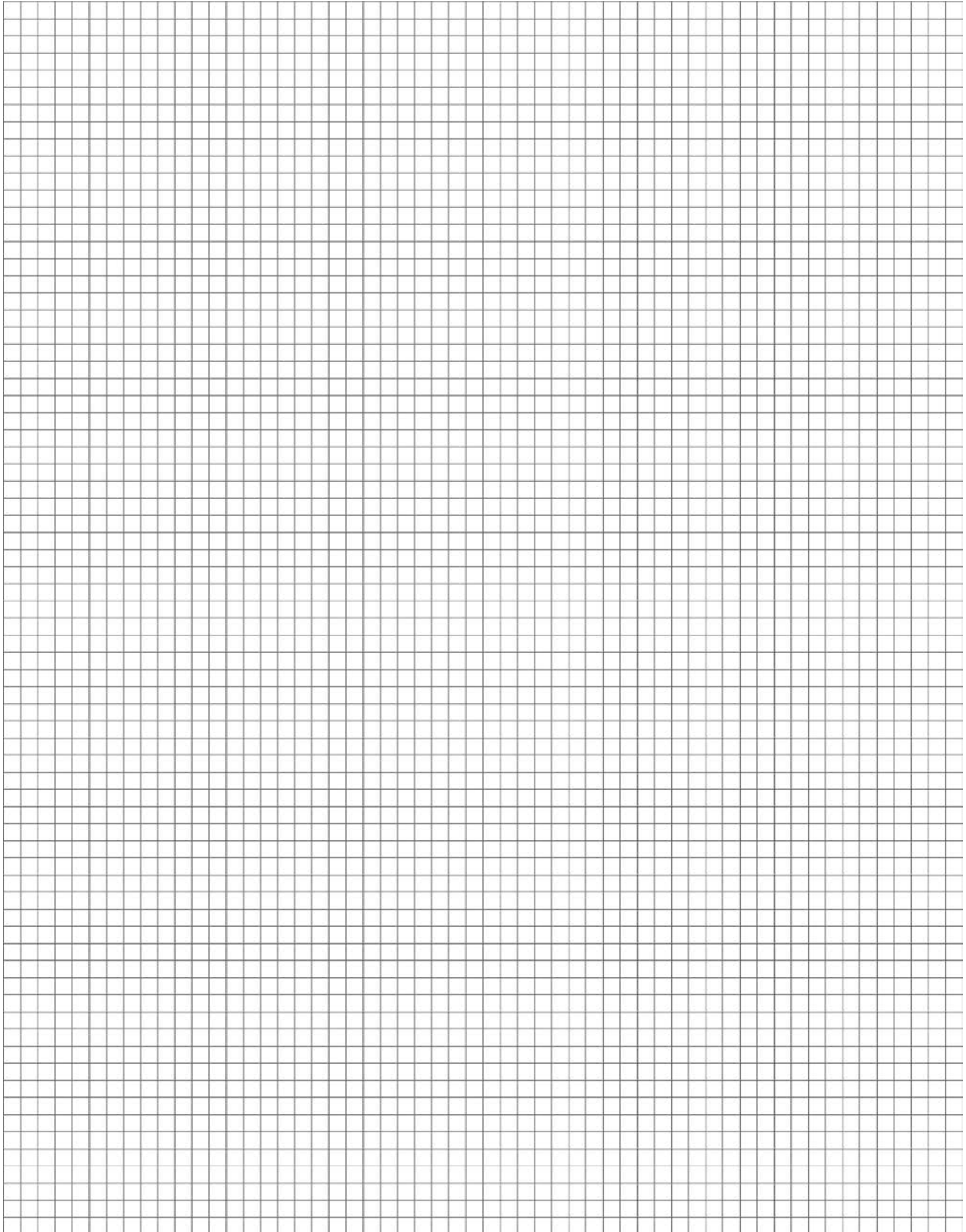

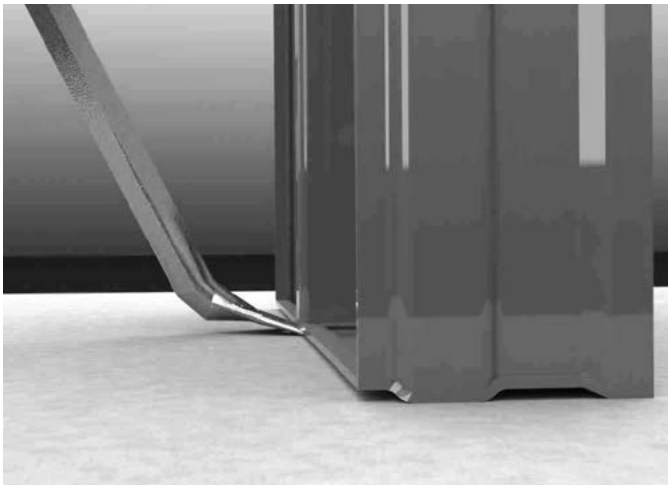

Symons Sym-Ply® concrete forming system is designed and manufactured to the demanding requirements of today's construction projects.

Features

- 1,500psf allowable pressure
- 80ksi steel for strength and durability
- Pins directly to Steel-Ply® panels, fillers, corners, hinges and pilaster forms
- Built-in tie-off holes meet OSHA requirements for fall protection
- Weighs only 8 pounds per square foot
- 5/8" 100/30 plywood face
- Profiled side rail allows pry bar access for adjusting gangs to the chalk line
- Clamp or bolt together for maximum versatility
- 17/16" diameter tie hole accommodates 15mm Taper Ties and She-Bolts
- Plywood protector sleeve plate is buttressed by the tie box for extended sleeve life
- Only 4" deep means more forms per truck
- Manufactured in the U.S.A.
- Manufactured by union workers
- Manufactured by Symons

Note: The drawings in this Application Guide are for illustrative purposes only. Local and federal requirements must be followed when erecting, dismantling or using Sym-Ply formwork. The information contained within this erection instruction is to be used as a guide and is not intended to replace sound engineering practice. Please consult your Symons representative for any application or product use that varies from the specific configurations depicted.

Basic Equipment

Panel Sizes

Sym-Ply panels incorporate 4" deep, high strength 80ksi steel encasing 5/8" 100/30 HDO plywood. The result is a light-weight, high capacity (1,500psf allowable pressure) forming system. The profiled side rail is shaped to allow clamping and has 13/16" diameter holes for wedge bolting directly to Steel-Ply.



P/C	Size	Weight
F56000	9' x 8'	739 lbs
F56001	36" x 8'	172 lbs
F56002	30" x 8'	155 lbs
F56003	24" x 8'	130 lbs
F56005	12" x 8'	73 lbs
F56006	6" x 8'	51 lbs
F56011	36" x 6'	136 lbs
F56012	30" x 6'	118 lbs
F56013	24" x 6'	100 lbs
F56015	12" x 6'	60 lbs
F56016	6" x 6'	39 lbs
F56021	36" x 4'	94 lbs
F56022	30" x 4'	85 lbs
F56023	24" x 4'	68 lbs
F56025	12" x 4'	40 lbs
F56026	6" x 4'	26 lbs
F56041	36" x 2'	53 lbs
F56042	30" x 2'	50 lbs
F56043	24" x 2'	38 lbs
F56045	12" x 2'	20 lbs

Fillers

Sym-Ply fillers are designed to be bolted directly or clamped into position with the Adjustable Sym-Clamp.

P/C	Size	Weight
F56007	2" x 8'	38.4 lbs
F56008	1" x 8'	32.8 lbs
F56017	2" x 6'	29.0 lbs
F56018	1" x 6'	24.0 lbs
F56027	2" x 4'	19.7 lbs
F56028	1" x 4'	16.6 lbs



1" Filler



2" Filler

Slip Plates

Slip Plates are used to fill in a 3" to 12" gap between gangs. They are very useful for reducing the number of different sized fillers required on a project. Slip Filler Plates lap over the panels, creating an indentation of 1/8" in the wall.

P/C	Size	Weight
F56009	14" x 8'	84 lbs
F56019	14" x 6'	64 lbs
F56029	14" x 4'	42 lbs

Steel-Ply Filler Angles

P/C	Size	Weight
F10826	8'	11 lbs
F10626	6'	9 lbs
F10426	4'	5 lbs



4' Slip Plate



Steel-Ply Filler Angle

Outside Corners

Profiled outside corners facilitate quick clamped connections.

P/C	Size	Weight
F56035	Sym-Ply OC x 8'	34 lbs
F56036	Sym-Ply OC x 6'	26 lbs
F56037	Sym-Ply OC x 4'	17 lbs

All-Steel Inside Corners

All-steel construction provides durability and eliminates re-plying.

P/C	Size	Weight
F56031	12" x 12" x 8'	163 lbs
F56032	12" x 12" x 6'	129 lbs
F56033	12" x 12" x 4'	87 lbs

Stripping Panels

Stripping Panels are made of two beveled forms that allow one to easily strip away from the other. They are most useful between gangs, pilasters, and inside corners. They are also used to create stripping cores.

P/C	Size	Weight
F56010	12" x 8'	136 lbs
F56020	12" x 6'	108 lbs
F56030	12" x 4'	73 lbs

Stripping Corners

The Sym-Ply Stripping Corners are a steel three-piece assembly which bolt together through side flanges that are biased 45 degrees relative to the form face. To facilitate stripping, the bolts are removed allowing the biased sides to slip by one another creating the required relief to strip the corners. These corners are most useful in a core application.

P/C	Size	Weight
F56091	12" x 12" x 8'	224 lbs
F56090	12" x 12" x 6'	167 lbs
F56089	12" x 12" x 4'	116 lbs

Sym-Ply Turnbuckle Bracket P/C F56093 3.2 lbs

The Sym-Ply Turnbuckle Bracket is used with the Stripping Corners and 27" Ratchet Turnbuckle in stripping core formwork. This bracket has the same spring loaded connection as other Sym-Ply Accessories so there are no loose parts.



4' Exterior Corner



4' Interior Corner

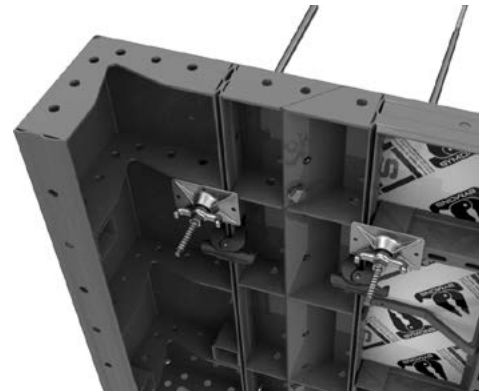

Stripping Panel



Stripping Corner



Sym-Ply Turnbuckle Bracket

Sym-Clamp® P/C F56351 3 lbs
 The Sym-Clamp is the lightest clamp on the market, yet it is extremely durable.

Adjustable Sym-Clamp P/C F56352 5 lbs
 Facilitates clamping plastic or lumber fillers up to 4" wide. It is the lightest adjustable clamp on the market.

Wedge Bolts P/C F60058 0.13 lbs
 Wedge Bolts can be used for quick attachment of Steel-Ply panels, fillers, corners, filler angles and pilaster forms.

¾" Speed Bolts and Nuts P/C F32191 0.54 lbs
 The 1³/₁₆" diameter side and end rail hole accommodate ¾" bolts and nuts if a bolted connection is desired. The nuts and bolts have 1¼" hexagonal heads.

Sym-Ply Handling Bar P/C F56353 1.4 lbs
 The Handling Bar is put into the holes of the panel siderails and used by workers to ease panel shake-out and gang assembly.

Sym-Ply Tie Down Bracket P/C F56395 4.4 lbs
 The Sym-Ply Tie Down Bracket is used to help resist uplift loads from battered wall applications or to simply pin a hang in place on the footing.

T-Head Sym-Bolt Assembly P/C F56062 4.0 lbs
 The T-Head Sym-Bolt attaches short walers for gangs over 16', or 5" walers when using the Space-Lift™ jump form system.

T-Head Sym-Bolt Assembly Long P/C F56096 4.3 lbs
 This longer T-Bolt allows the use of Symons Soldier® and 8" walers with the Sym-Ply Clamp System.

NOTE: When using the T-Head Sym-Bolt Assembly, always be sure that the T-Handle is perpendicular to the slot length and the T-Head is fully engaged. Then hand-tighten the wing nut plus a quarter turn.



Sym-Clamp



Adjustable Sym-Clamp



Wedge Bolt



¾" Speed Bolt and Nut



Sym-Ply Handling Bar



Sym-Ply Tie Down Bracket

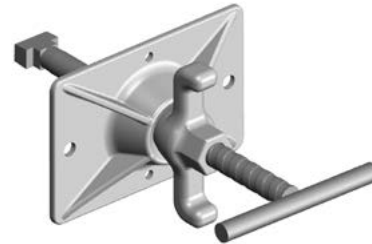

T-Head Sym-Bolt Assembly

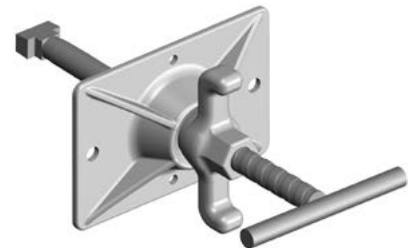

T-Head Sym-Bolt Assembly Long

Bulkhead Sym-Hook Long

P/C F56097 3.6 lbs

Used to attach the Short Waler supporting bulkhead lumber at construction joints.



Bulkhead Sym-Hook Long

Sym-Waler, 5'

P/C F56064 38 lbs

The 60" long Sym-Waler stiffens gangs over 16' tall, supports slip plates, and provides bulkhead support.

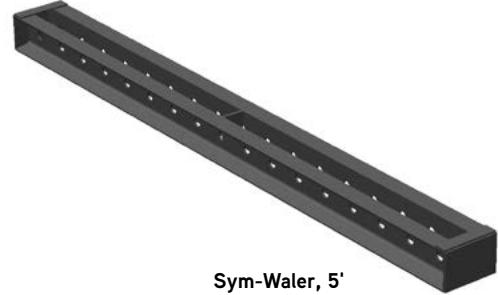

Sym-Waler, 5'

Sym-Waler, 10'

P/C F56098 86 lbs

The 10' and 13' long Sym-Walers are used to stiffen gangs during the picking and placement process.

Sym-Waler, 13'

P/C F56099 112 lbs

Sym-Ply Stacking Clamp

P/C 56914 23.5 lbs

The Sym-Ply Stacking Clamp is used instead of the Sym-Waler to stiffen the gang during picking and placement processes.

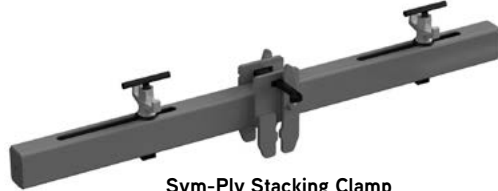

Sym-Ply Stacking Clamp

Sym-Ply Tie-Off Bracket

P/C F56092 1.8 lbs

The Sym-Ply Tie-Off Bracket meets OSHA requirements for fall protection. The connecting hardware is fully integrated so there is no loose hardware. The bracket can be placed during gang assembly and the spring loaded connection allows it to be moved quickly and easily if required.



Sym-Ply Tie-Off Bracket

Plastic Sleeve Plate

P/C F56070 0.05 lbs

The Plastic Sleeve Plate for Sym-Ply provides plywood protection at tie hole locations. The plate design fits behind the tie box and has two holes which can be used to screw the plate in custom locations in the panel. A plastic plug (F56071) can be placed into the opening when a tie hole is not being used.

15mm Sleeve Insert

P/C F56084 0.02 lbs

The Sleeve Insert reduces the tie hole diameter from 1.44" to 1.13", greatly reducing concrete seepage when 15mm Taper Ties are used. The insert snaps into the existing Sleeve Plate. A smaller plastic plug (F56085) can be placed into the insert opening when a tie hole is not being used.



Plug



15mm Sleeve Insert



Plastic Sleeve Plate

15mm x 4" x 6" Tie/Plate Nut F722110 2.2 lbs
 Attaches Short Walers when used in combination with 15mm ties and the Bulkhead Sym-Bolt.



Tie Systems

P/C	Size	Weight
15 MM Ties		
FSW667023	41" Taper Tie	5.1 LBS
FSW667022	49" Taper Tie	6.5 LBS
FSW667021	57" Taper Tie	7.9 LBS
FSW667020	65" Taper Tie	9.3 LBS
F54680	15 MM Taper Tie Hammering Tool	0.5 LBS
F722110	15 MM X 4" X 6" Tie/Plate Nut	2.2 LBS
F54557	15mm Nut	1.01 LBS
20 MM Ties		
145555	20 MM 37" Taper Tie	8.2 LBS
145556	20 MM 47" Taper Tie	11 LBS
145557	20 MM 57" Taper Tie	13.9 LBS
145558	20 MM 67" Taper Tie	15.8 LBS
145554	20 MM Swivel Wing Nut W/ 7" DIA Plate	5.94 LBS
123605	20 MM B12AW Wing Nut	1.51 LBS
20 MM She-Bolt		
123504	D30A - 20 MM X 18" SHE-BOLT	3.29 LBS
123506	D30A - 20 MM X 24" SHE-BOLT	3.96 LBS
145554	B12ASW Swivel Wing Nut W/ Round Plate	5.94 LBS

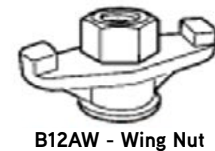
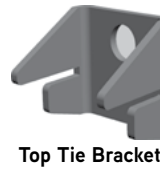
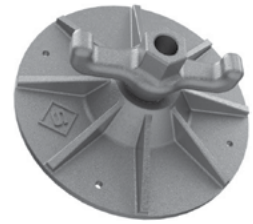

NOTE: 20 MM Taper Ties must be used with 9' x 8' SYM-PLY PANEL to achieve 1,500 lbs. poor pressure. 15 MM ties can be used with the 9' x 8' panel at a reduced concrete poor rate of 1,000 lbs./psf

Family Part Code for MTO sizes of D9A 20 MM TT & D30A She-Bolt - is 43500

Top Tie Bracket P/C F56069 4.3 lbs
 The Top Tie Bracket is used for dry tie application at the top of the panel or in a bulkhead situation. (See sections on Top Tie Brackets, Bulkheads, and Other Tying Considerations) Capacity of 7,000 lbs. at a 2 to 1 factor of safety.

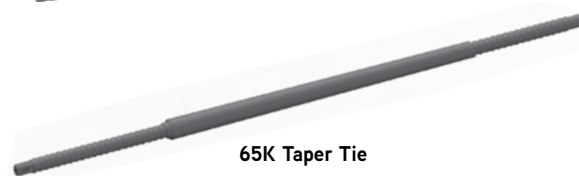
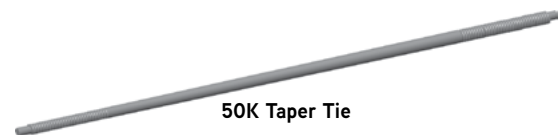
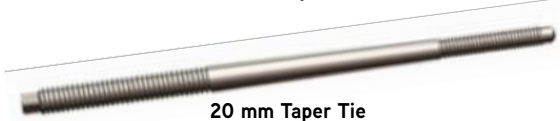

Form Alignment and Attachments

Pipe Form Aligner P/C F33697 111 lbs.
Aligns formwork panels. Connects to panel siderails with Wedge Bolts.

Pier Cap Brace
Aligns formwork panels. Connects to panel siderails with Wedge Bolts.

P/C	Description	Lbs.
F39979	67½" Pier Cap Brace	42
F39980	85½" Pier Cap Brace	48
F39981	56" Extension	16
F39982	92" Extension	26
F40132	5/8" dia. x 4½" Pin	0.4
F36653	Hair Pin Clip	0.2

Brace Kicker Bracket P/C F33693 7.3 lbs.
Acts as an aligner shoe for connecting an aligner and a kicker.

Aligner Bracket P/C F56066 3.3 lbs
The Aligner Bracket uses the same integrated hardware as the other accessories. It is designed to accept multiple types of plumbing and bracing devices.



Attachment to Rails



Attachment to Aligner Bracket



Aligner Bracket

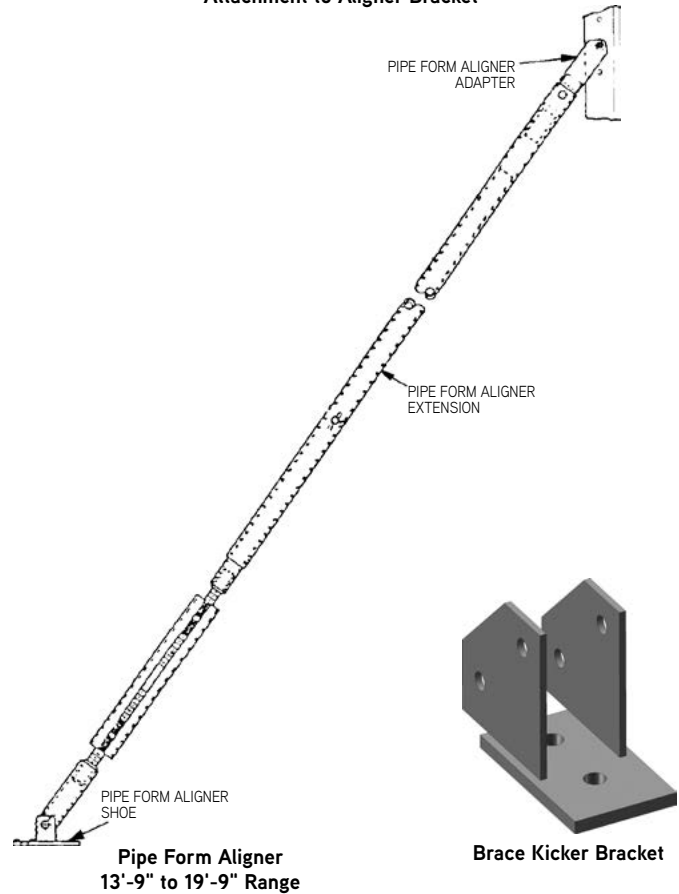
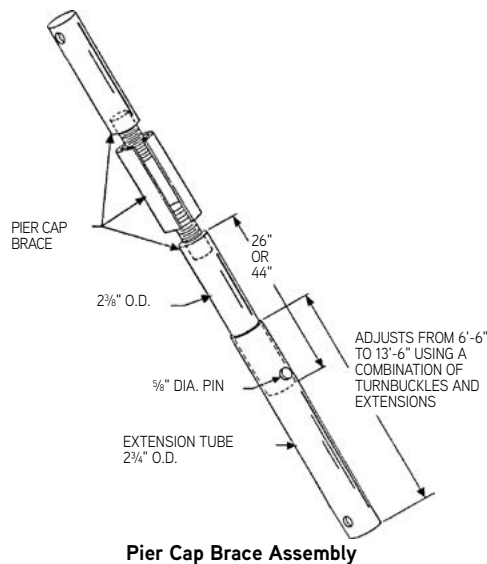

Clamps

Clamps shall be adjacent to tie hole locations.

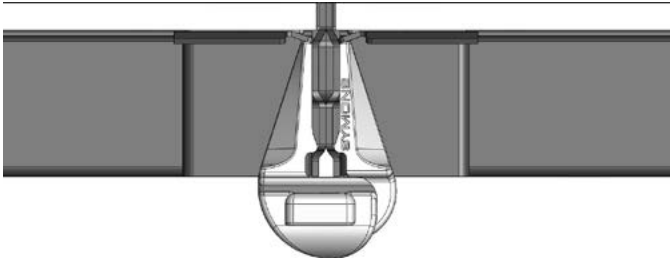

Sym-Clamp Plan View



Adjustable Sym-Clamp with 2" Filler



Clamp Adjacent to Tie Box



Adjustable Sym-Clamp with 4" Filler



Adjustable Sym-Clamp with 1" Filler

Bolts

When using a bolted connection, a $\frac{3}{4}$ " bolt shall be located at the first hole location from crossmembers/endmembers, endrails or tie-off bars.

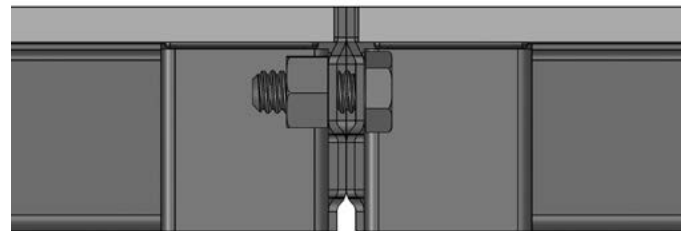

Typical Bolt Connection

Sym-Ply Gang Assembly



1. Ensure lay down area is sufficient for the largest gang to be assembled and any equipment access required during assembly and picking of the gang(s). The lay down area should be clear and flat. It is recommended to place timber under the panels to ease in panel alignment and speed assembly time.
2. Align the bottom and one side of the gang using a snap line or other means.
3. Install one clamp per vertical and horizontal joint to lock in the gang. DO NOT over-tighten the clamps.
4. Install the vertical Sym-Walers at the recommended locations with the shim side bearing on the vertical cross-members and tighten the "J" hook and the T-Head Sym-Bolt Assemblies. Vertical Stacking Clamps may be used in place of Sym-Walers per gang assembly chart options shown in the following pages. If horizontal walers are required, install them after the vertical walers. In some cases, the clamps directly below horizontal walers may need to be placed and tightened first.
5. Install remaining Sym-Clamps as required ensuring panel edges remain flush. A spud bar may aide in alignment at times. DO NOT over-tighten the clamps.
6. Install lift brackets, brace brackets, scaffold brackets, and other accessories as required.
7. Lift and set gang.

IMPORTANT: See following pages for proper clamp and waler or stacking clamp locations. Please consult your Regional Engineer with questions.

Stacking Panels Gang Options with Stacking Clamps

Sym-Waler with T-Head
Sym-Bolt used for
horizontal alignment

Sym-Ply Stacking Clamps

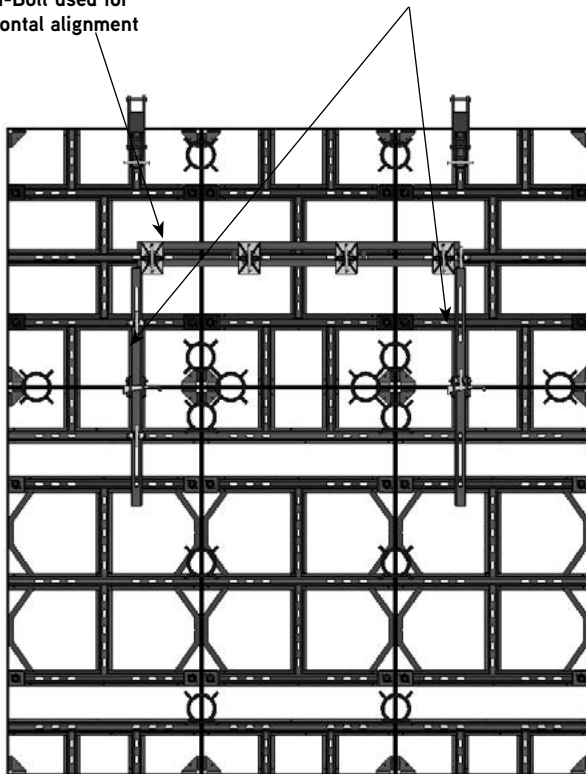

GANG – 3'-0" Wide x 6'-0" High + 4'-0" High x 3 Panels Wide

NOTES:

1. For gangs over 24' high, use 5" or 8" Walers to stiffen. Consult a Regional Engineer.
2. When using the T-Head Sym-Bolt Assembly, always be sure that the T-Handle is perpendicular to the slot length and the T-Head is fully engaged. Then hand-tighten the wing nut plus a quarter turn.
3. Crossed circle (⊗) in drawings indicates Sym-Clamp location.
4. Lift Bracket locations shown help prevent excessive flex during front or back picks.
5. One row of clamps must be placed at the very top edge at panel joints.

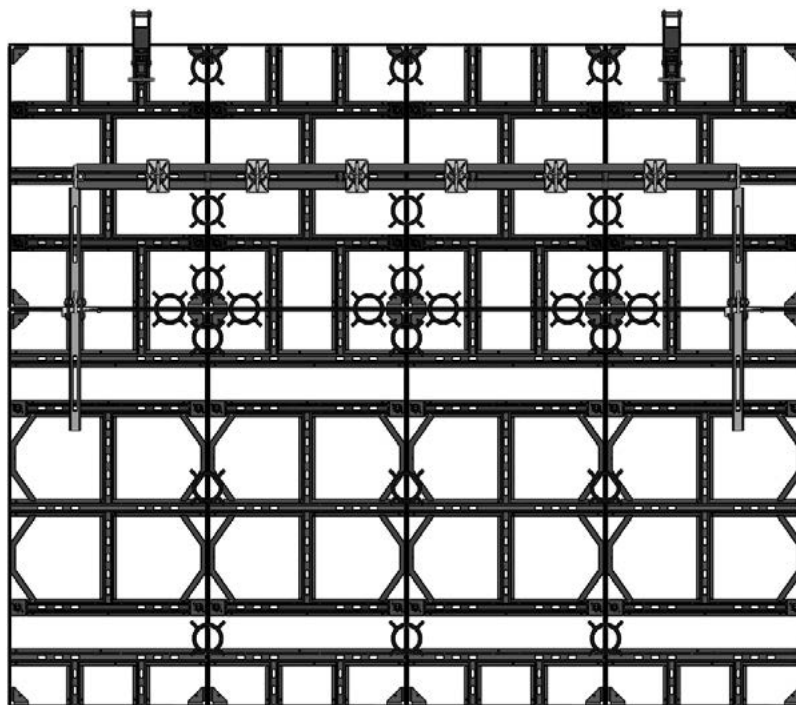

GANG – 3'-0" Wide x 6'-0" High + 4'-0" High x 4 Panels Wide

Sym-Ply Gang Options with Stacking Clamps, continued

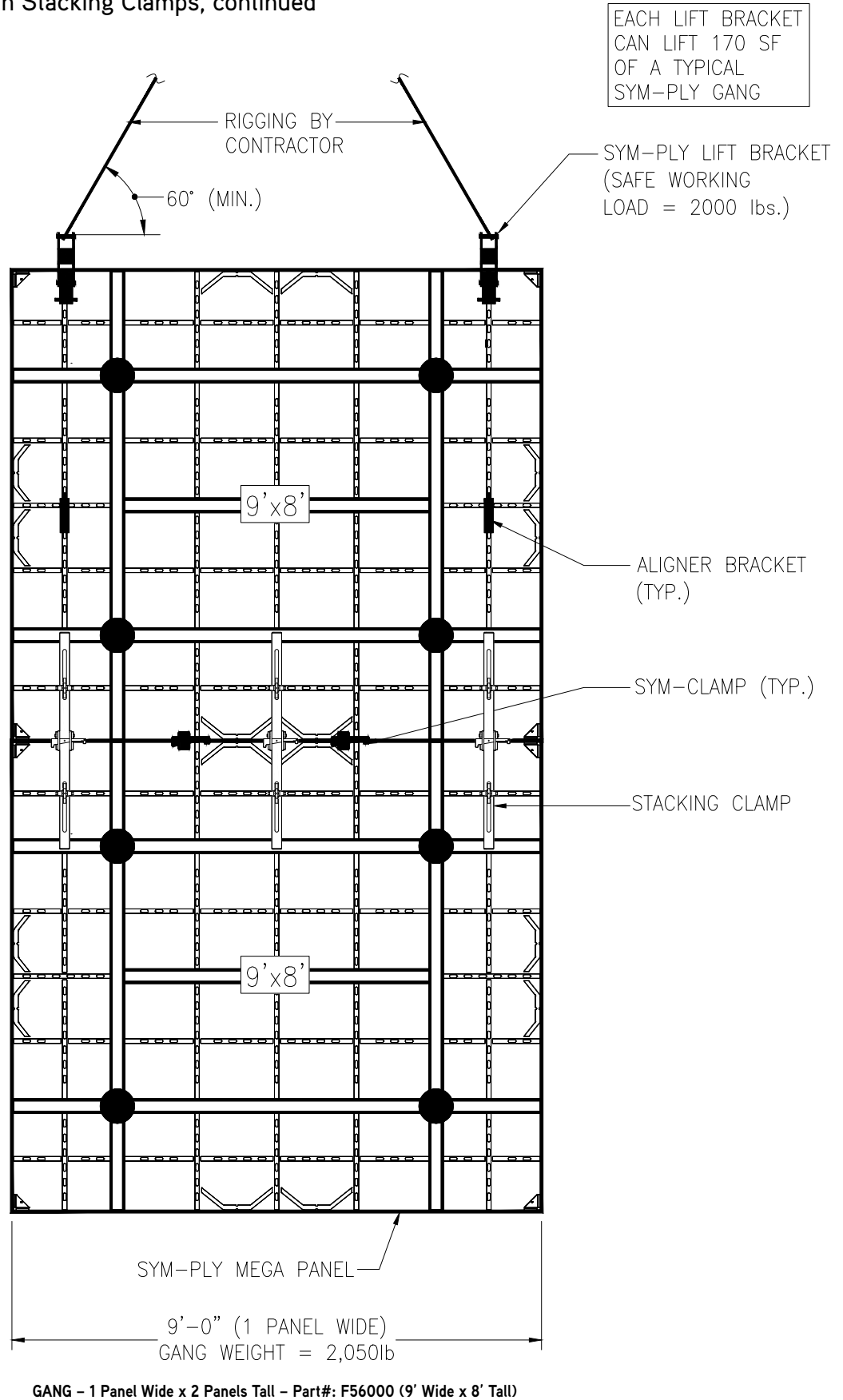

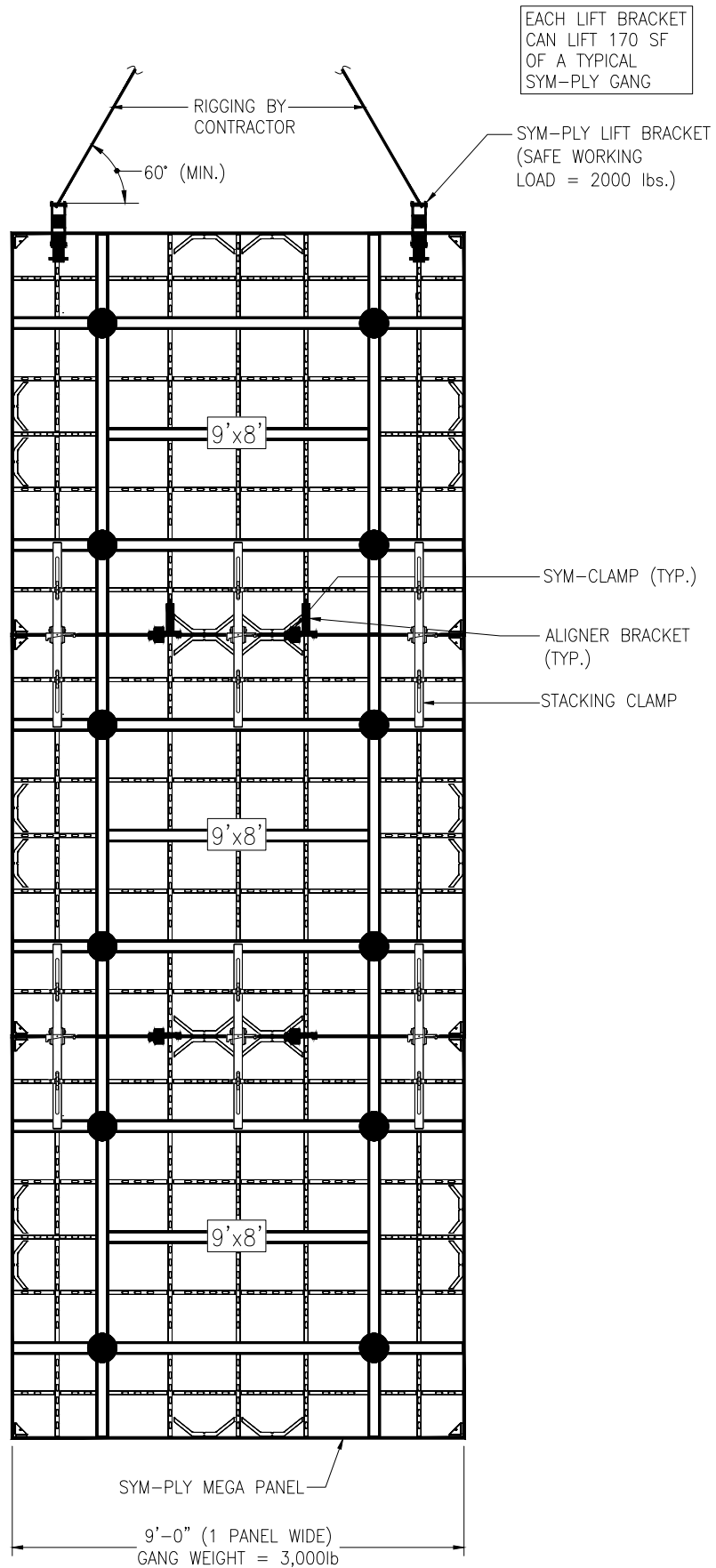

GANG - 1 Panel Wide x 3 Panels Tall - Part#: F56000 (9' Wide x 8' Tall)

Sym-Ply Gang Options with Stacking Clamps, continued

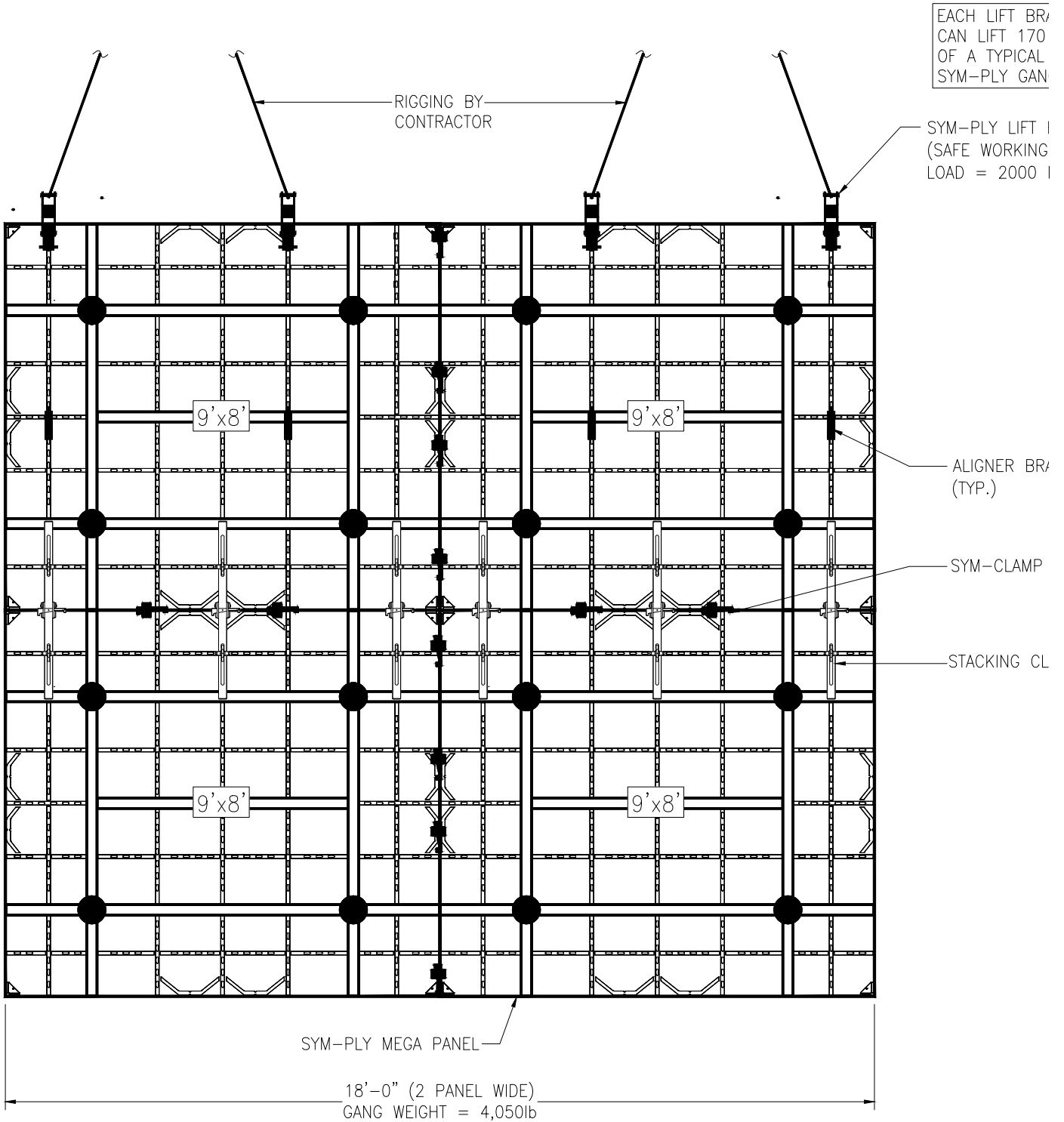

GANG - 2 Panels Wide x 2 Panels Tall - Part#: F56000 (9' Wide x 8' Tall)

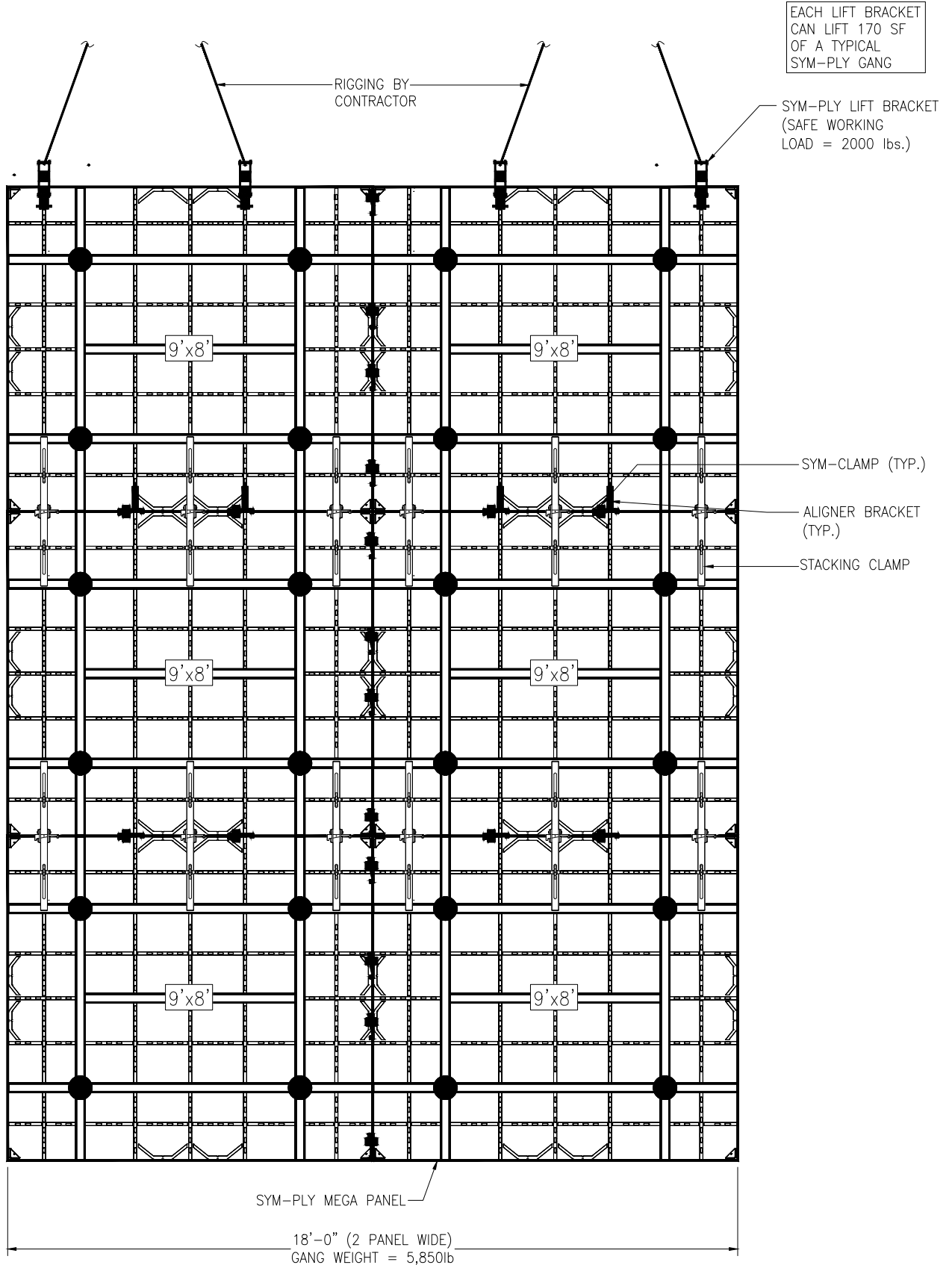

GANG - 2 Panels Wide x 3 Panels Tall - Part#: F56000 (9' Wide x 8' Tall)

Sym-Ply Gang Options with Stacking Clamps, continued

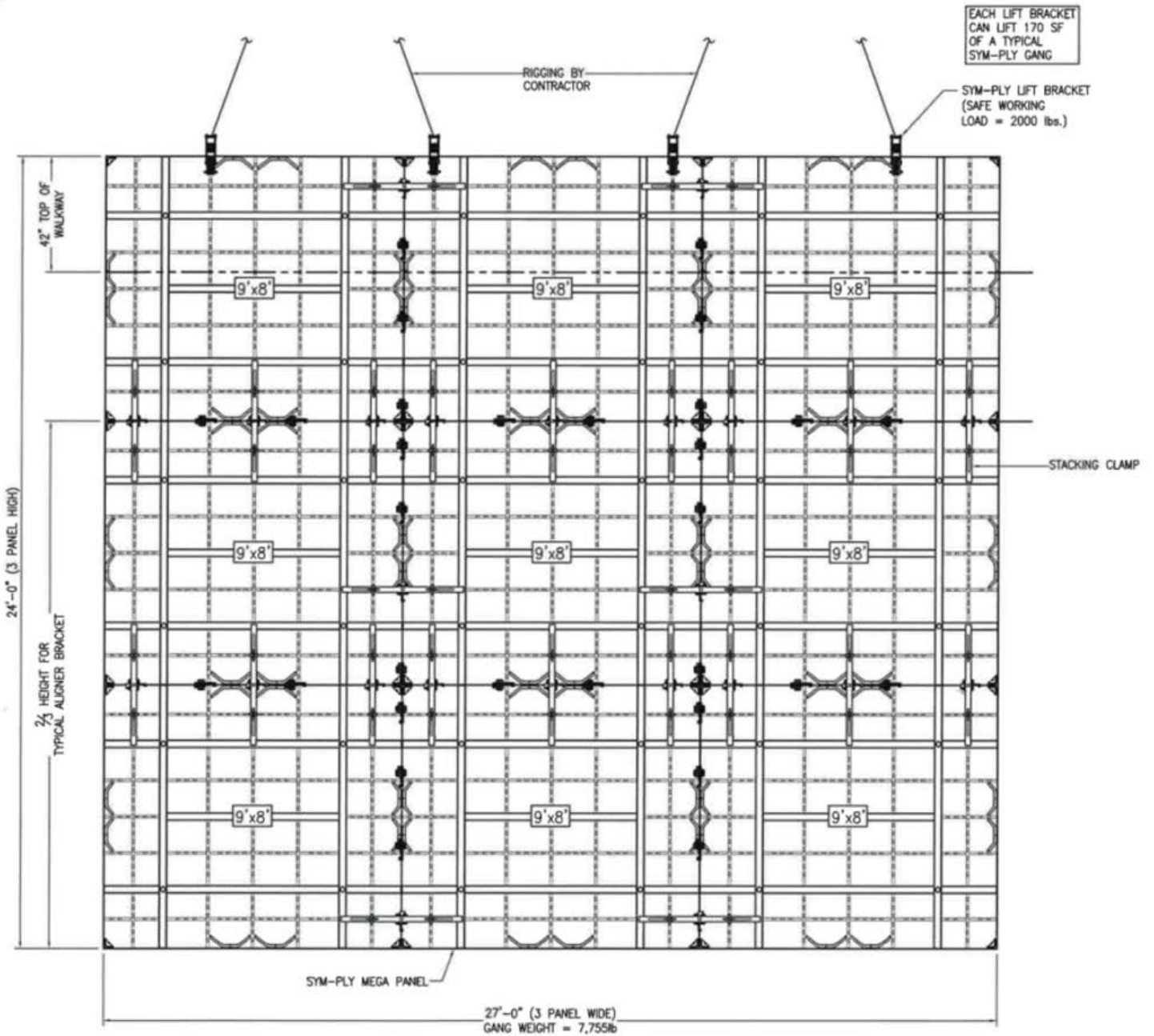

3 (9x8 Panels) Wide x 3 (9x8 Panels) Tall

- Lift Bracket locations help prevent excessive flex during front or back picks
- 60" long horizontal Sym-Waler prevents excess flex when laying panels on back (use 6 T-Head Sym-Bolts)
- One row of clamps **MUST** be placed at the very top edge at panel joints

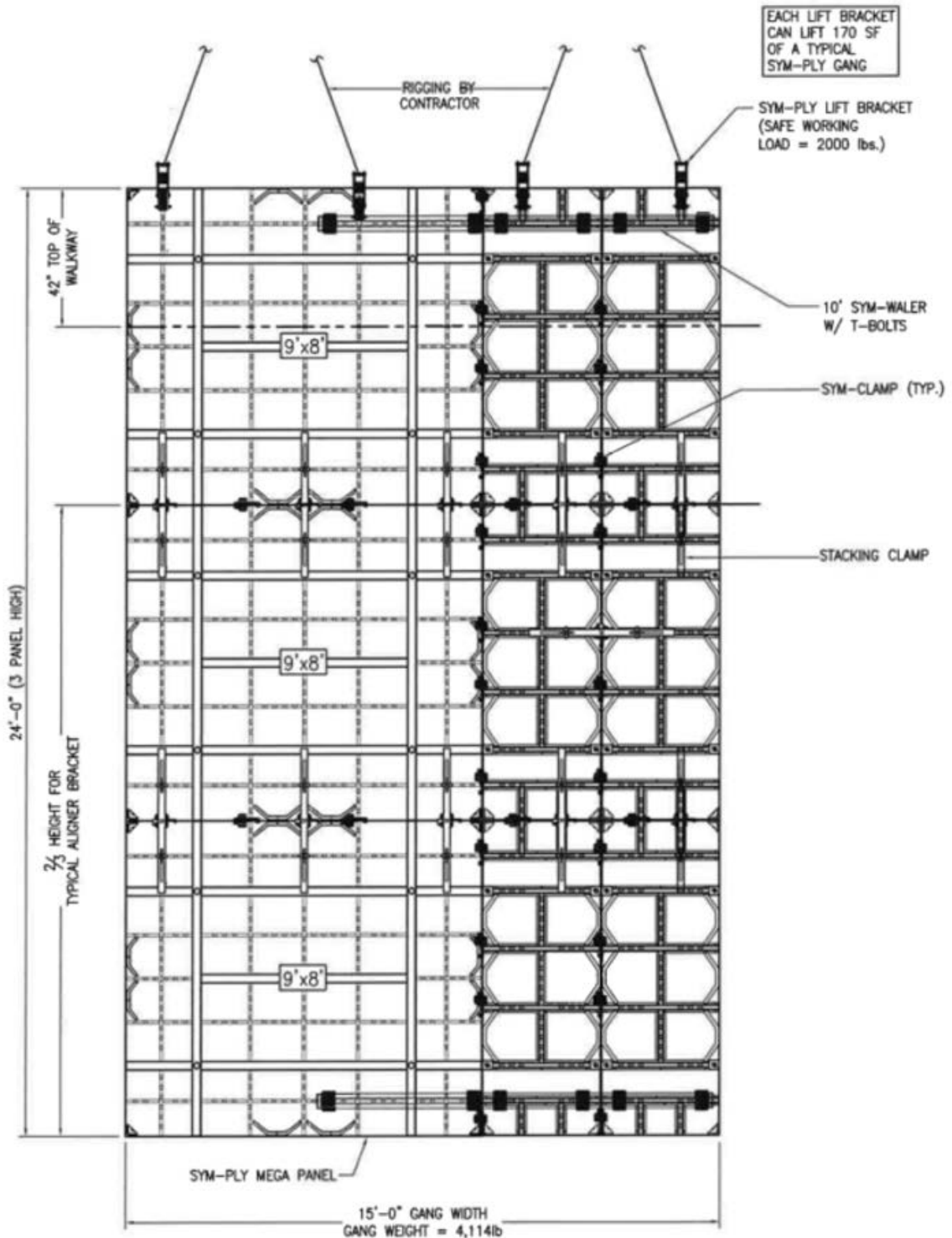

Example Gang Attachment of 9x8 Panel to 3x8 Panel

- Lift Bracket locations help prevent excessive flex during front or back picks
- 60" long horizontal Sym-Waler prevents excess flex when laying panels on back
(use 6 T-Head Sym-Bolts)
- One row of clamps **MUST** be placed at the very top edge at panel joints

Sym-Ply Gang Options with Stacking Clamps, continued

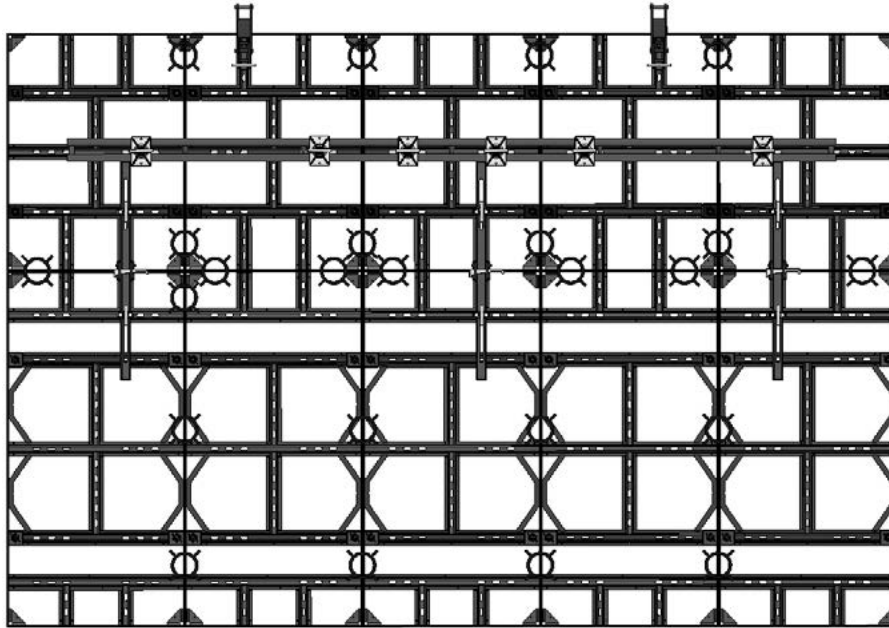

GANG – 3'-0" Wide x 6'-0" High + 4'-0" High x 5 Panels Wide

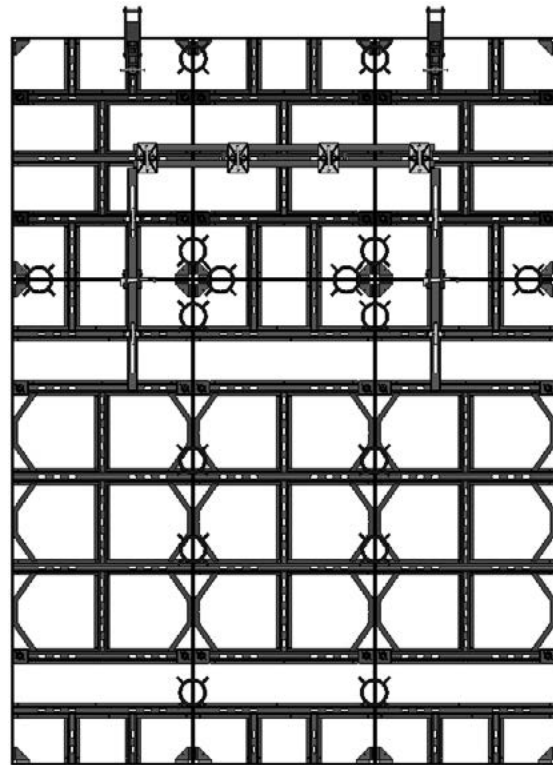

GANG – 3'-0" Wide x 8'-0" High + 4'-0" High x 3 Panels Wide

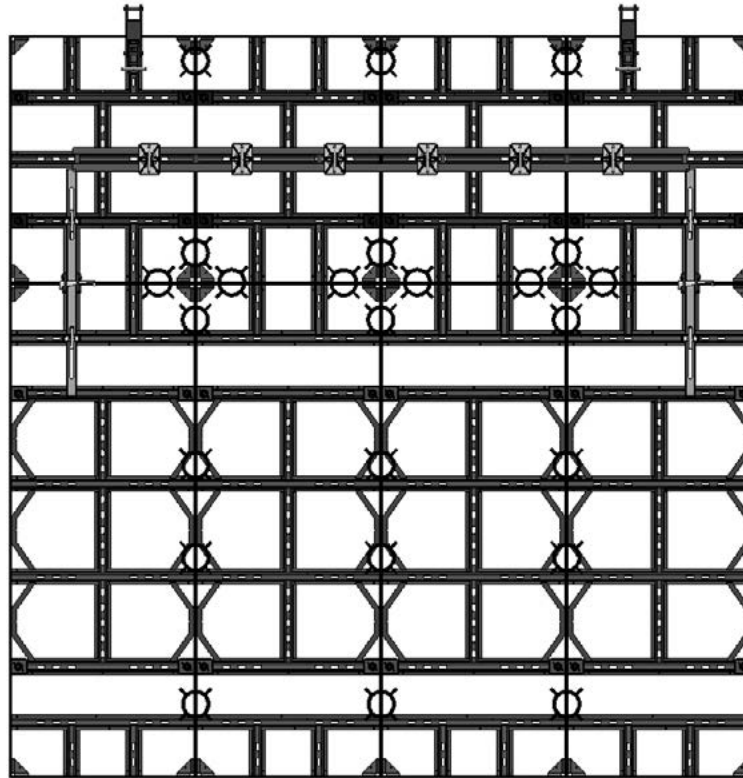

GANG — 3'-0" Wide x 8'-0" High + 4'-0" High x 4 Panels Wide

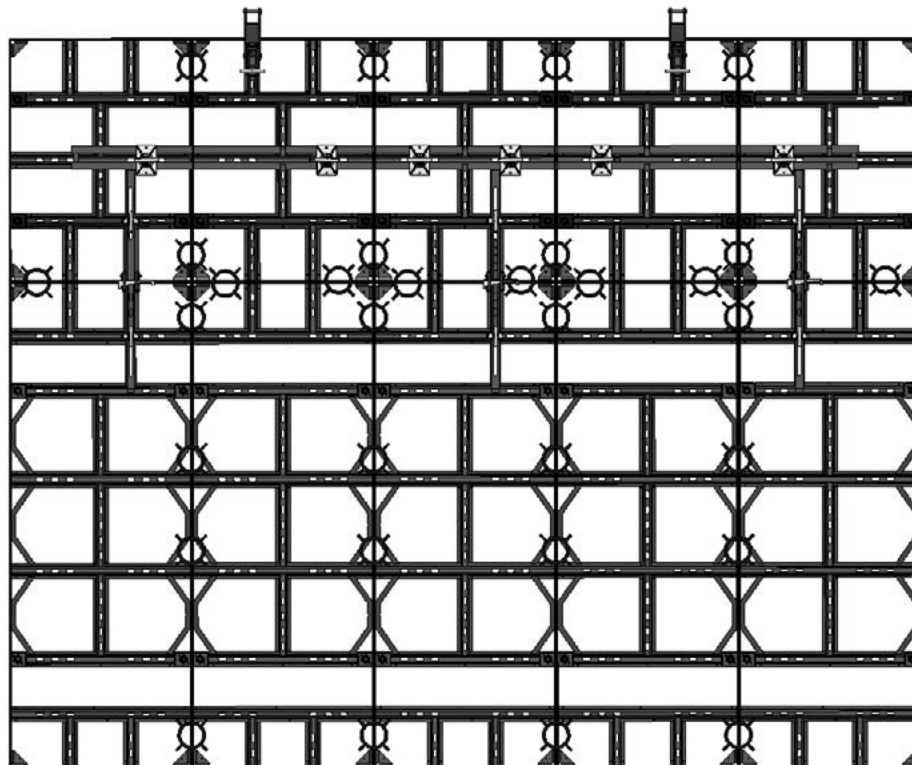

GANG — 3'-0" Wide x 8'-0" High + 4'-0" High x 5 Panels Wide

Sym-Ply Gang Options with Stacking Clamps, continued

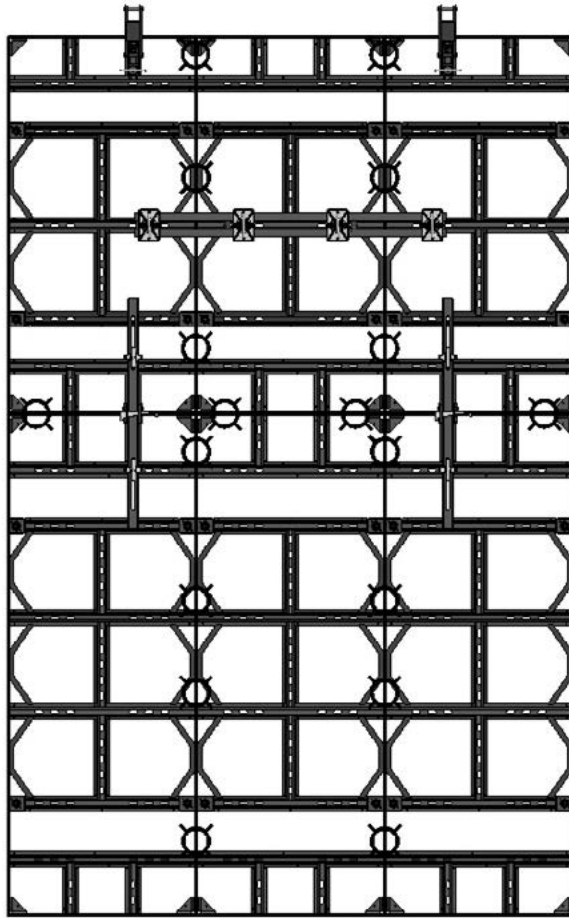

GANG — 3'-0" Wide x 8'-0" High + 6'-0" High x 3 Panels Wide

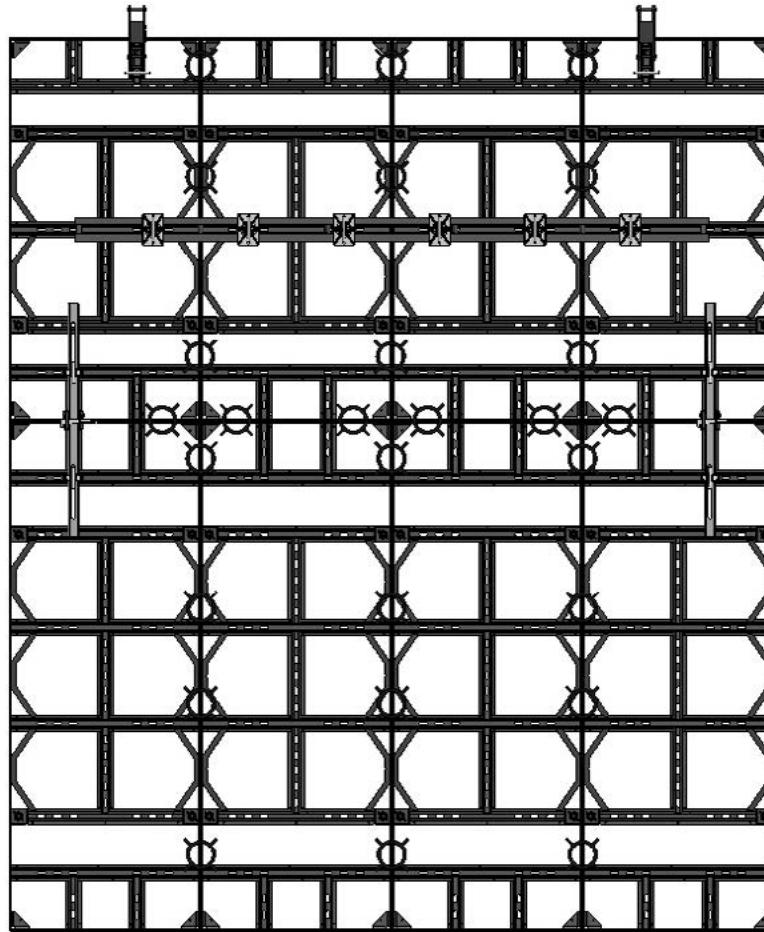

GANG — 3'-0" Wide x 8'-0" High + 6'-0" High x 4 Panels Wide

Sym-Ply Gang Options with Stacking Clamps, continued

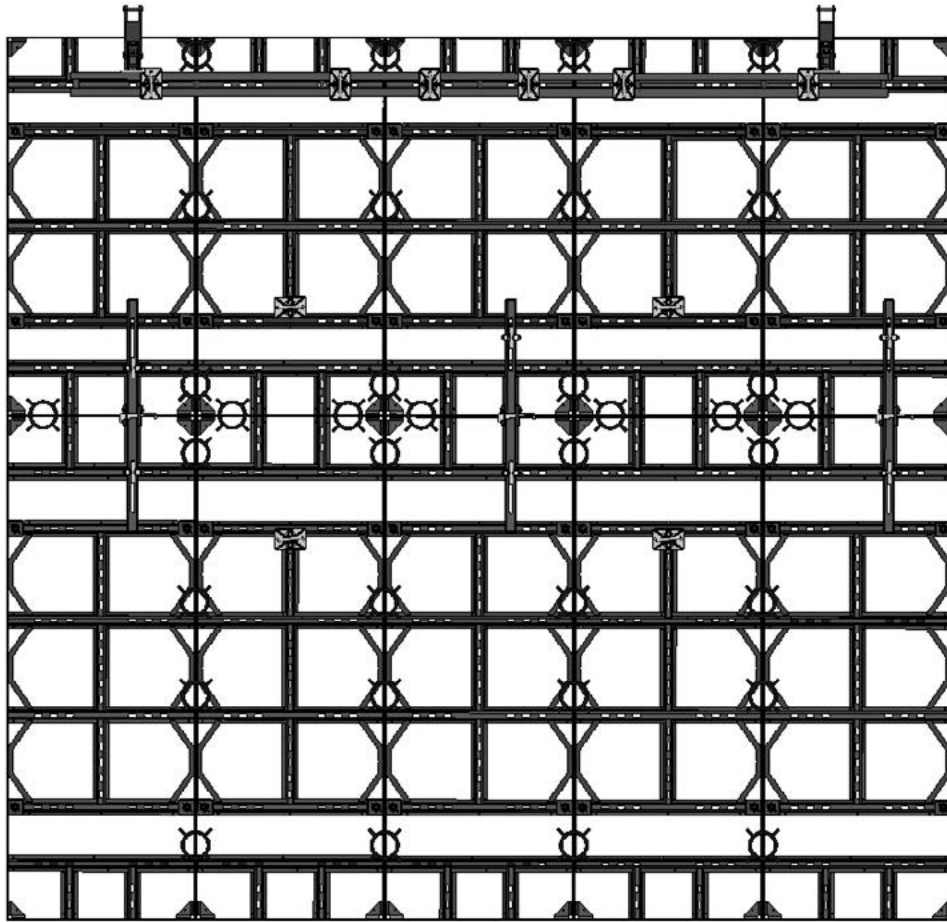

GANG — 3'-0" Wide x 8'-0" High + 6'-0" High x 5 Panels Wide

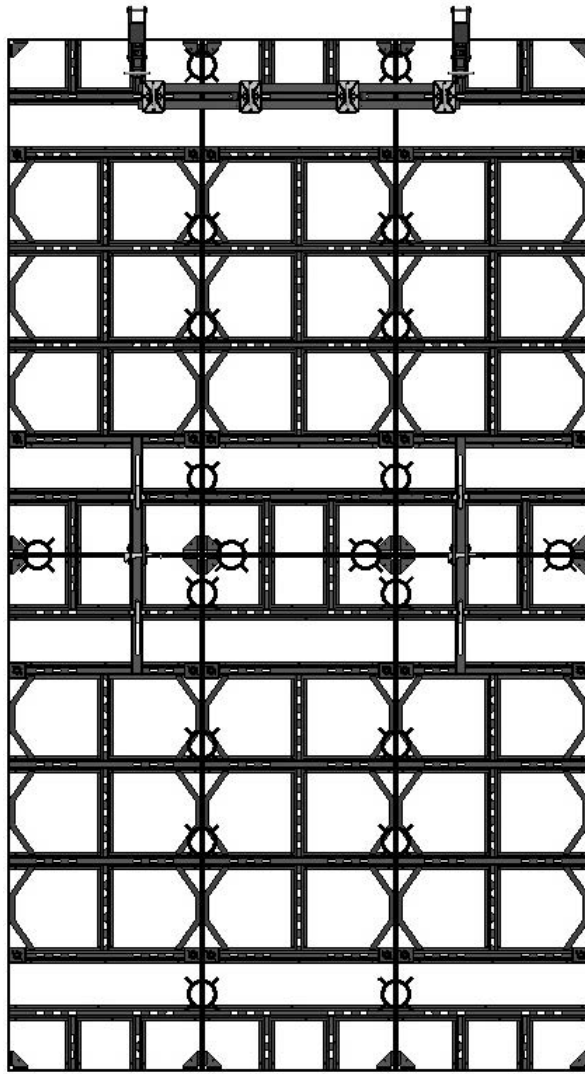

GANG — 3'-0" Wide x 8'-0" High + 8'-0" High x 3 Panels Wide

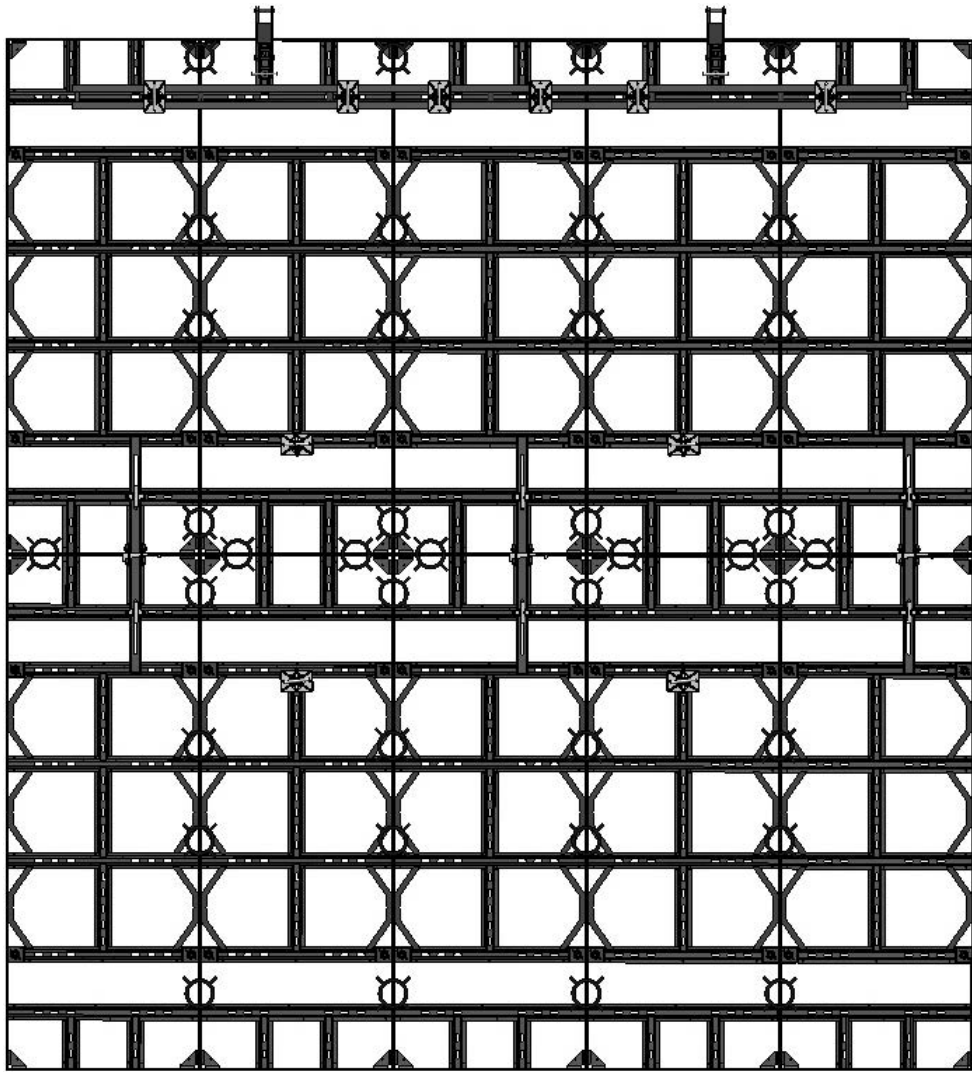

GANG — 3'-0" Wide x 8'-0" High + 8'-0" High x 5 Panels Wide

Sym-Ply Gang Options with Stacking Clamps, continued

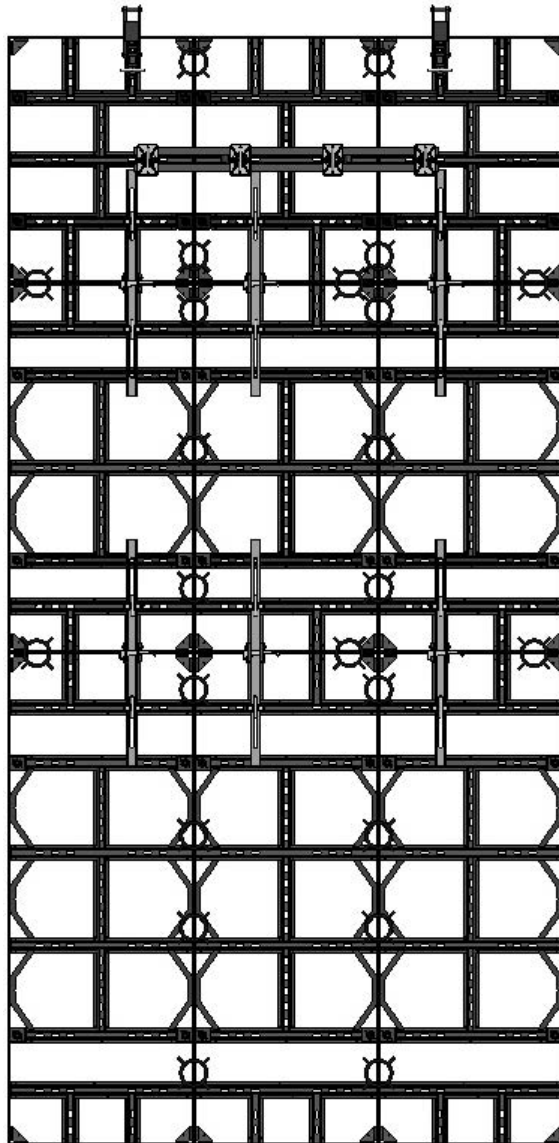

GANG – 3'-0" Wide x 8'-0" High + 6'-0" High + 4'-0" High x 3 Panels Wide

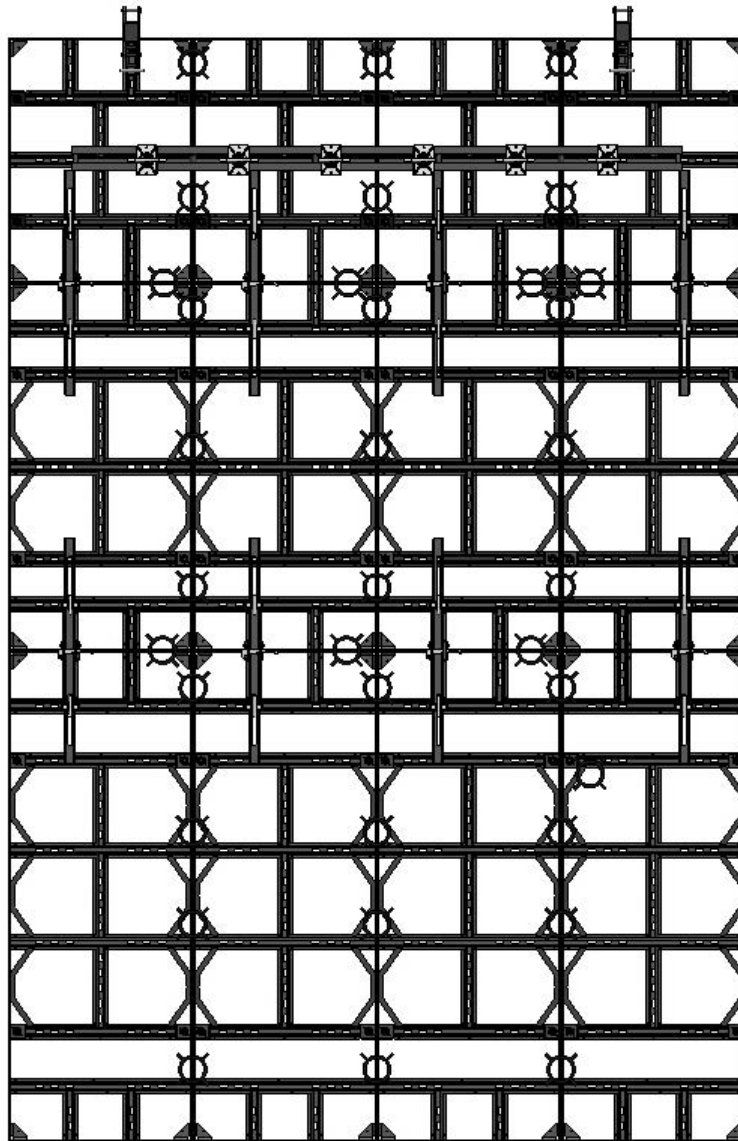

GANG – 3'-0" Wide x 8'-0" High + 6'-0" High + 4'-0" High x 4 Panels Wide

Sym-Ply Gang Options with Stacking Clamps, continued

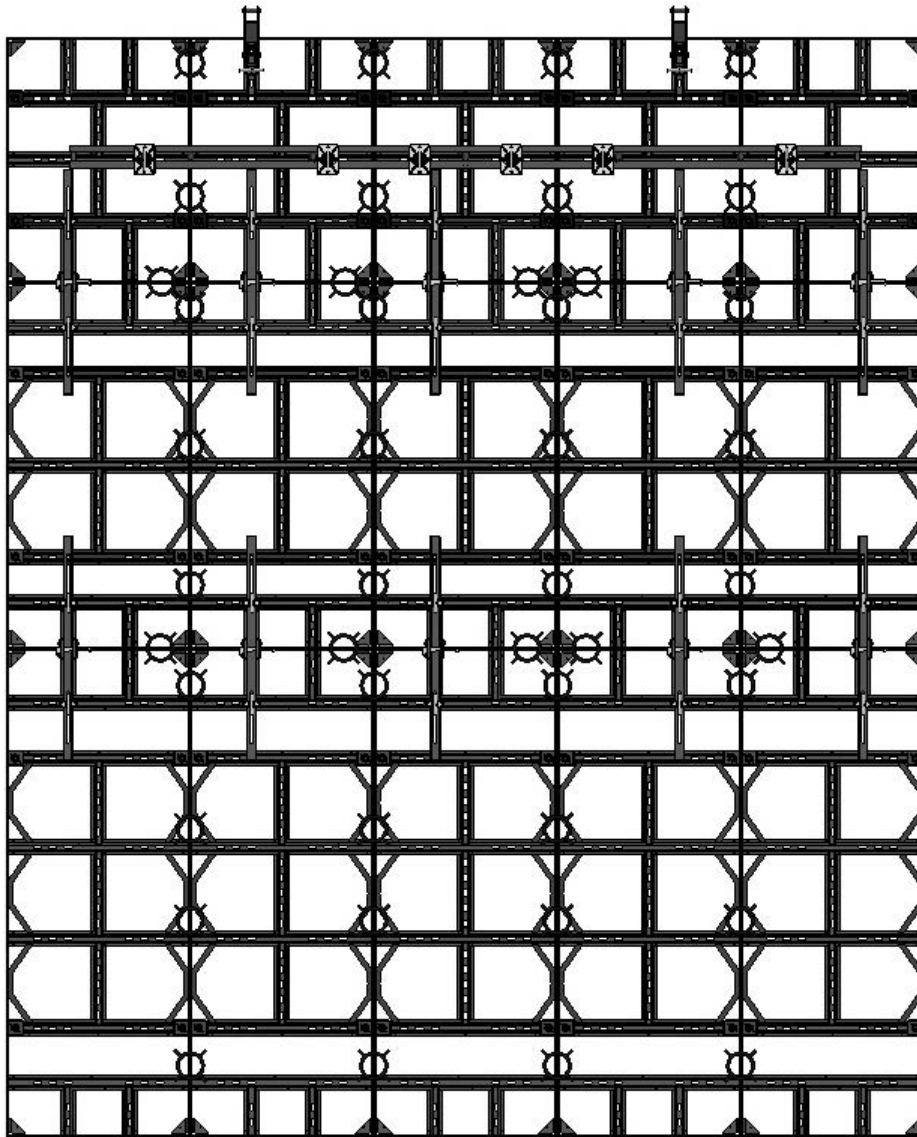

GANG – 3'-0" Wide x 8'-0" High + 6'-0" High + 4'-0" High x 5 Panels Wide

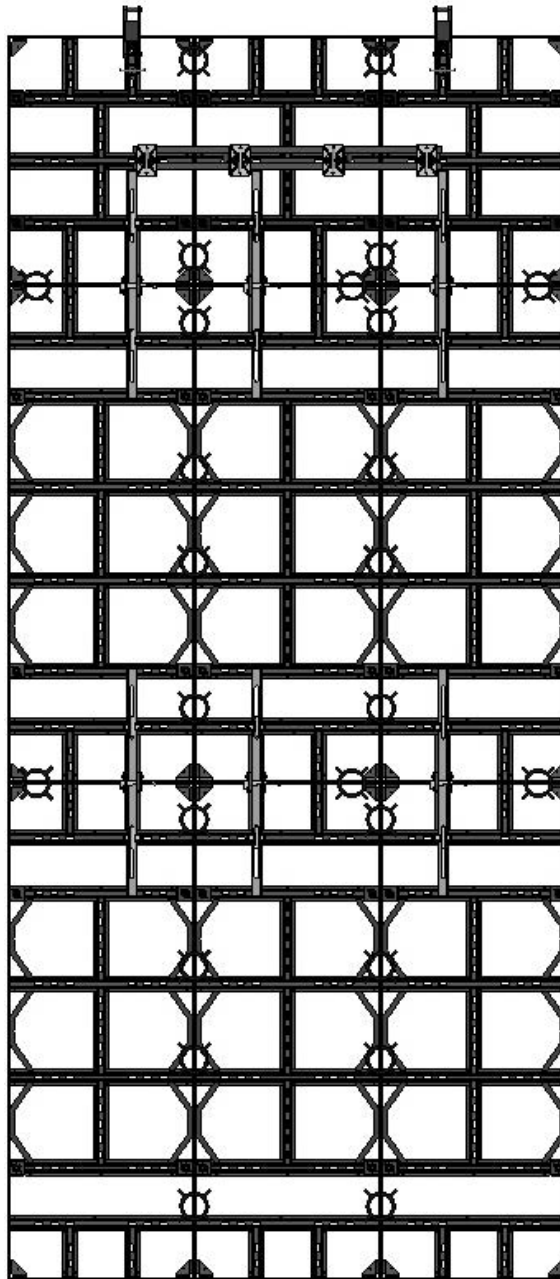

GANG – 3'-0" Wide x 8'-0" High + 8'-0" High + 4'-0" High x 3 Panels Wide

Sym-Ply Gang Options with Stacking Clamps, continued

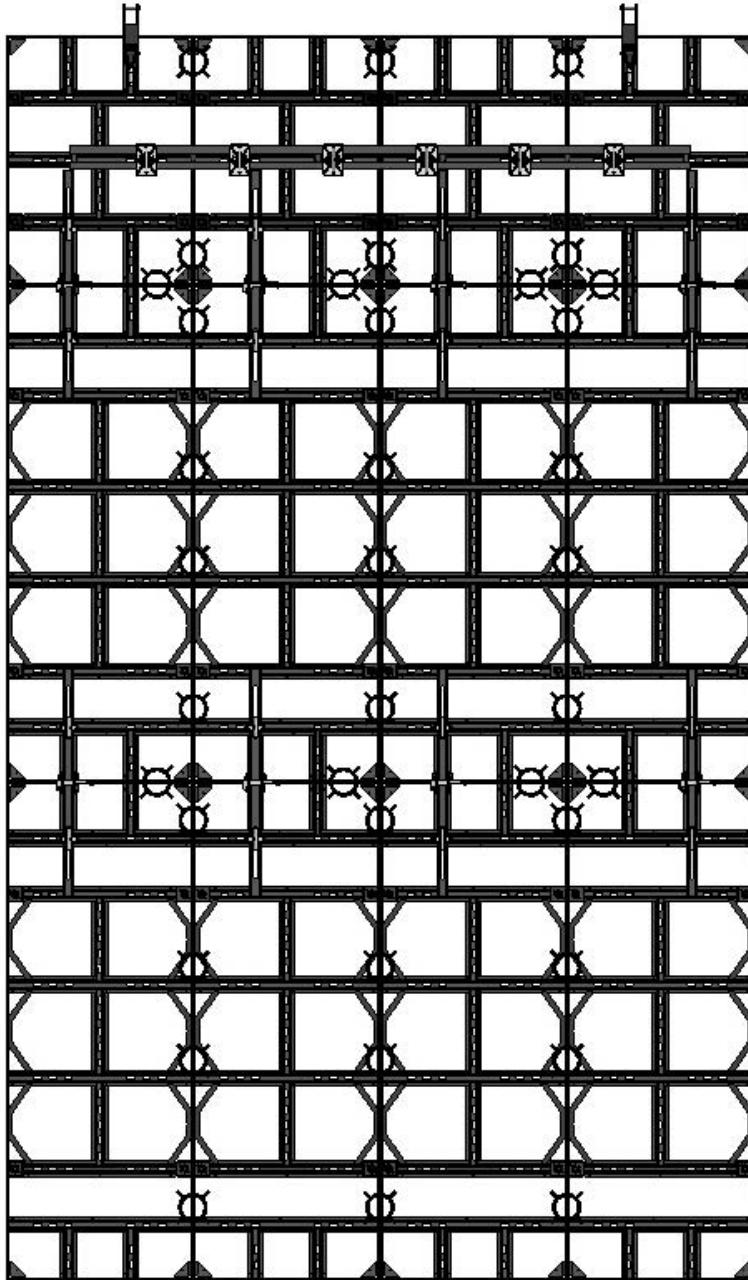

GANG – 3'-0" Wide x 8'-0" High + 8'-0" High + 4'-0" High x 4 Panels Wide

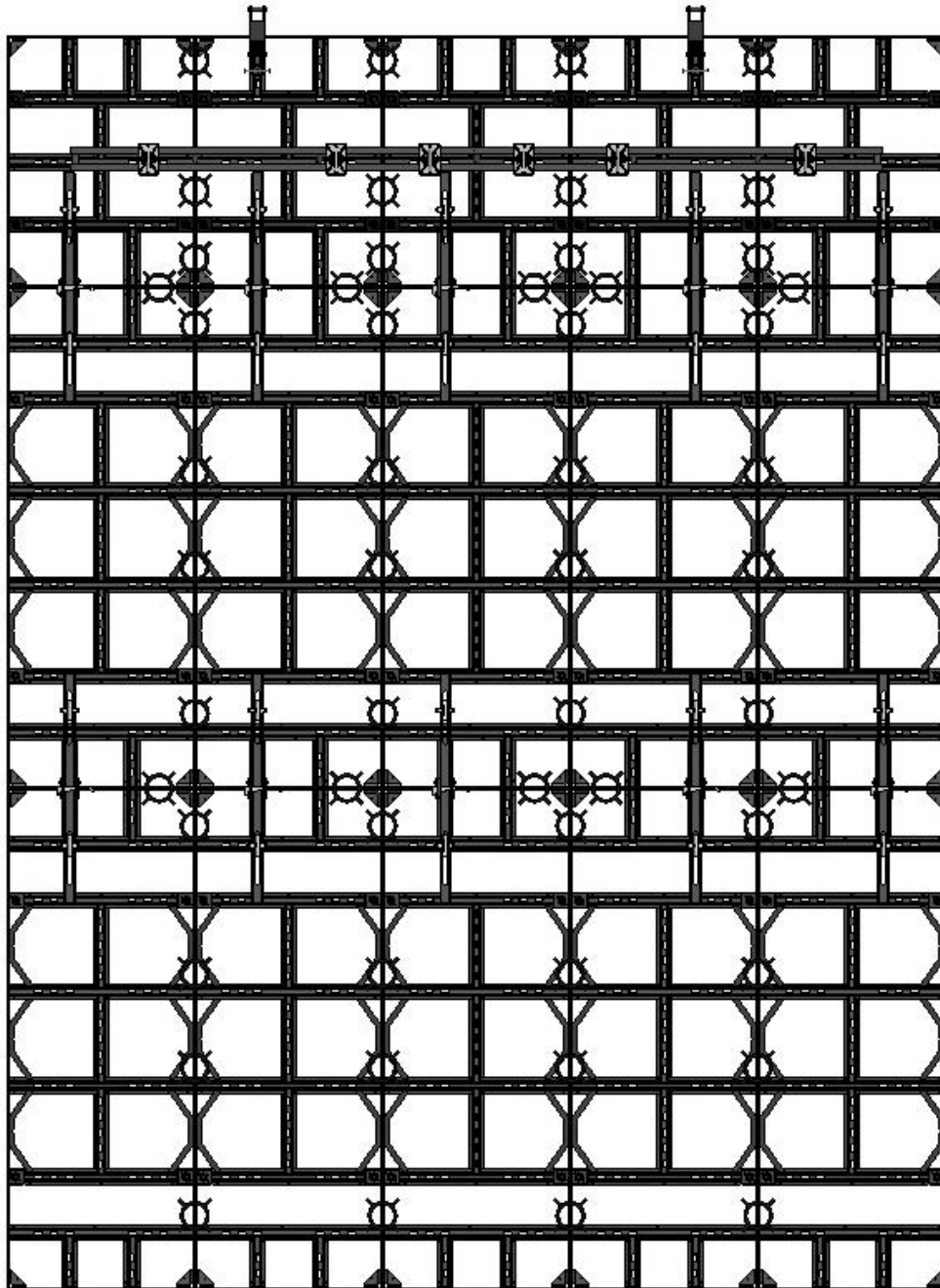

GANG – 3'-0" Wide x 8'-0" High + 8'-0" High + 4'-0" High x 5 Panels Wide

Sym-Ply Gang Options with Stacking Clamps, continued

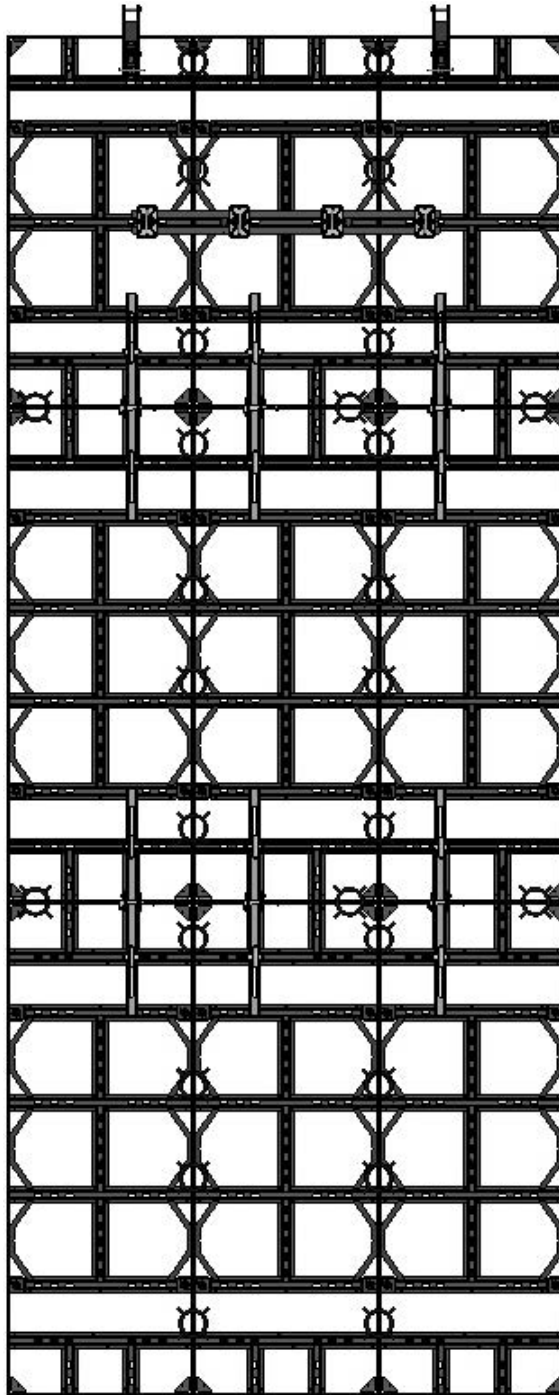

GANG – 3'-0" Wide x 8'-0" High + 8'-0" High + 6'-0" High x 3 Panels Wide

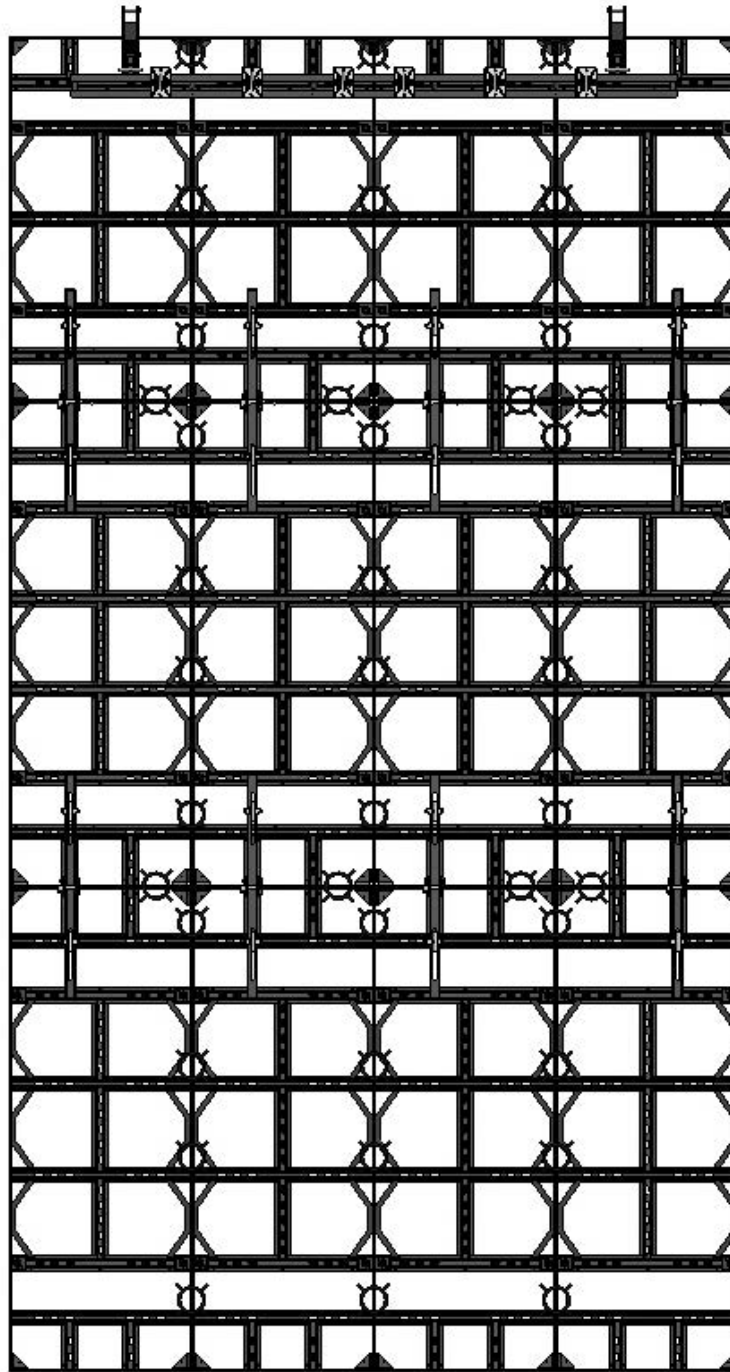

GANG – 3'-0" Wide x 8'-0" High + 8'-0" High + 6'-0" High x 4 Panels Wide

Sym-Ply Gang Options with Stacking Clamps, continued

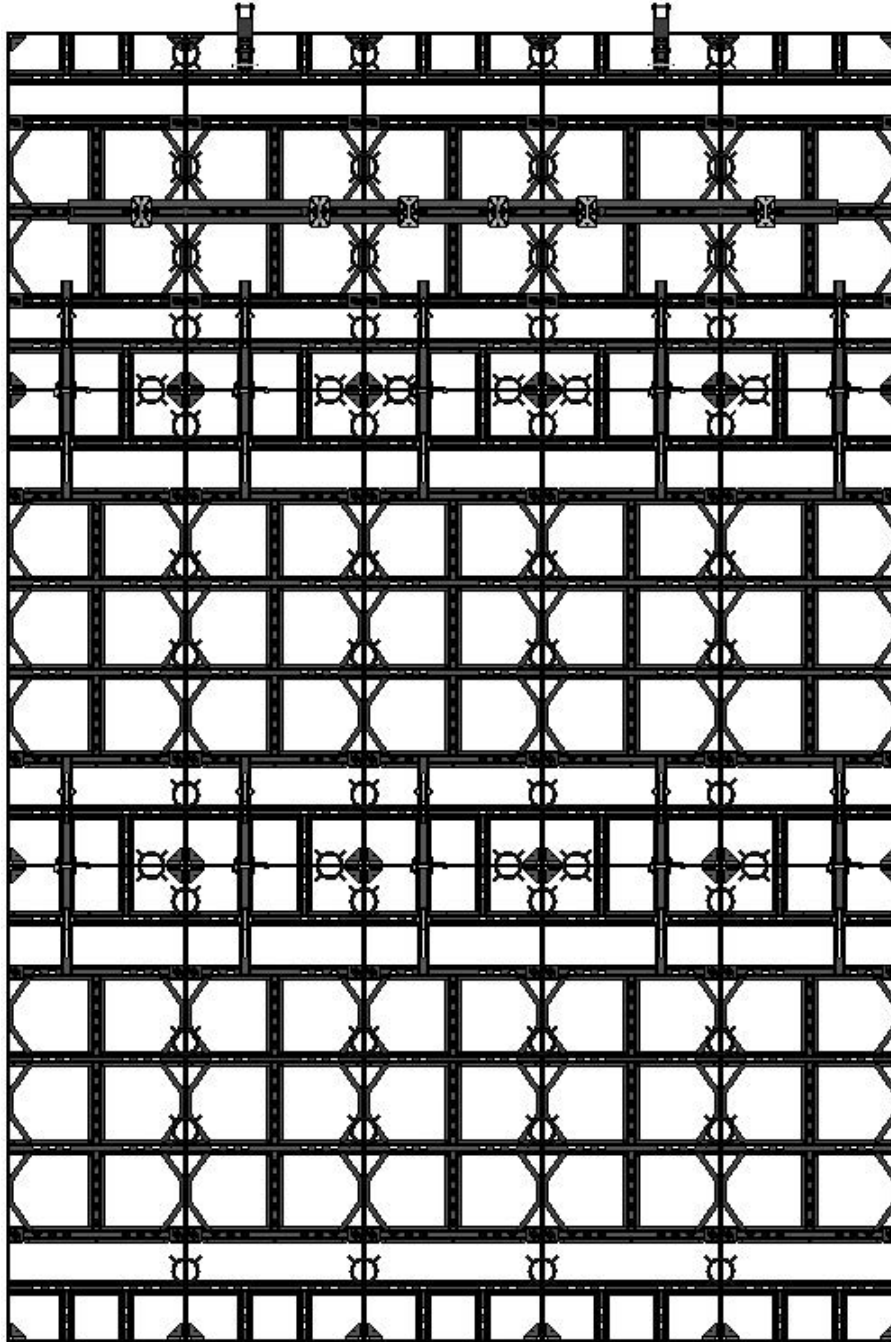

GANG – 3'-0" Wide x 8'-0" High + 8'-0" High + 6'-0" High x 5 Panels Wide

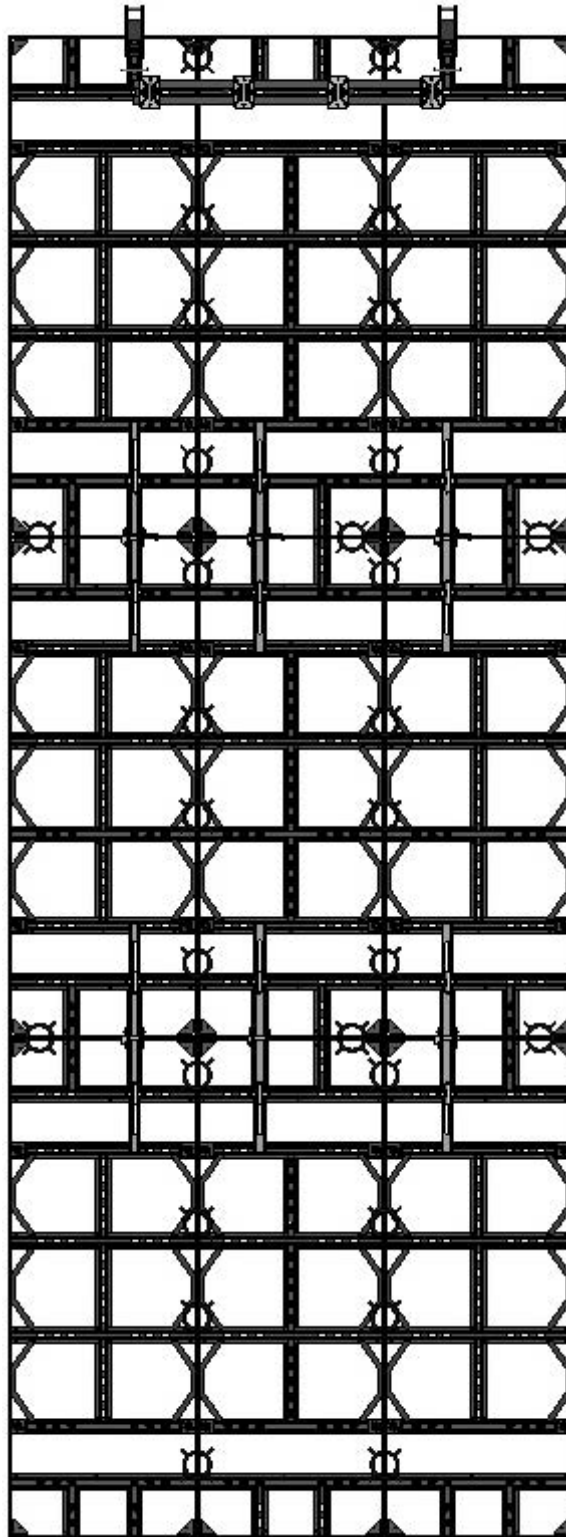

GANG – 3'-0" Wide x 8'-0" High + 8'-0" High + 8'-0" High x 3 Panels Wide

Sym-Ply Gang Options with Stacking Clamps, continued

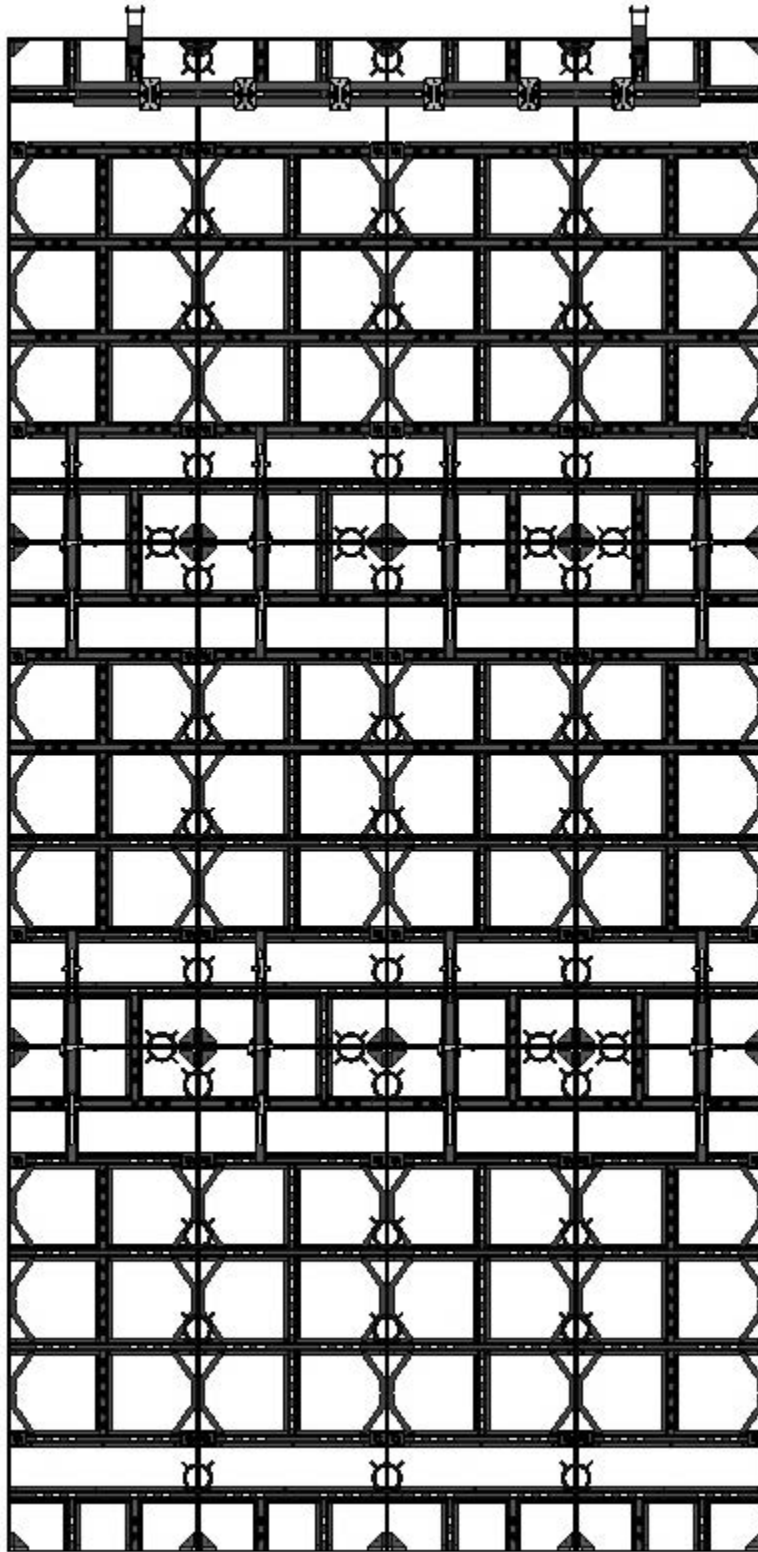

GANG – 3'-0" Wide x 8'-0" High + 8'-0" High + 8'-0" High x 4 Panels Wide

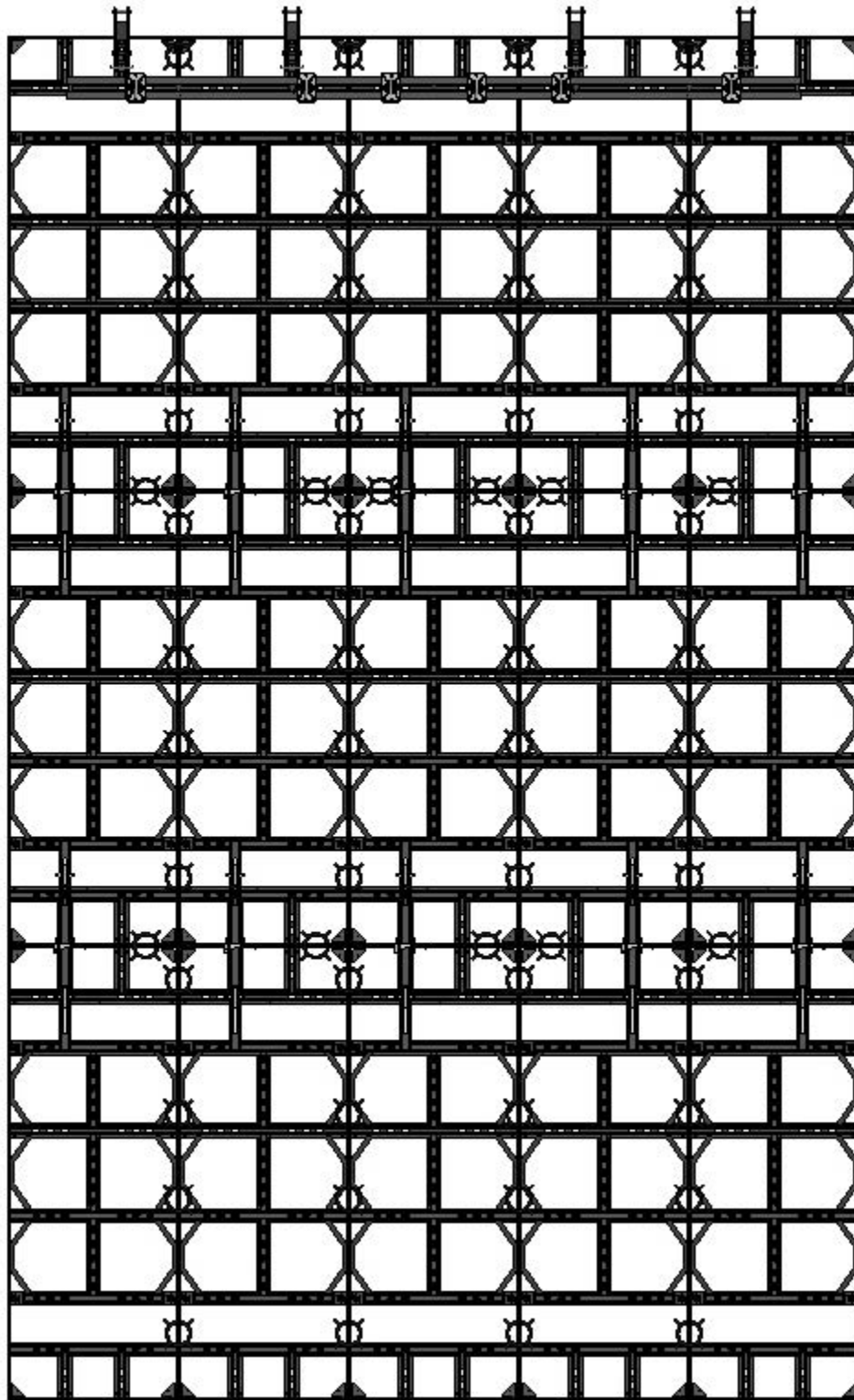

GANG – 3'-0" Wide x 8'-0" High + 8'-0" High + 8'-0" High x 5 Panels Wide

Stacking Panels with Sym-Walers

NOTES:

1. For gangs over 24' high, use 5" or 8" Walers to stiffen. Consult a Regional Engineer.
2. When using the T-Head Sym-Bolt Assembly, always be sure that the T-Handle is perpendicular to the slot length and the T-Head is fully engaged. Then hand-tighten the wing nut plus a quarter turn.
3. Crossed circle (⊗) in drawings indicates Sym-Clamp location.
4. Lift Bracket locations shown help prevent excessive flex during front or back picks.
5. One row of clamps must be placed at the very top edge at panel joints.

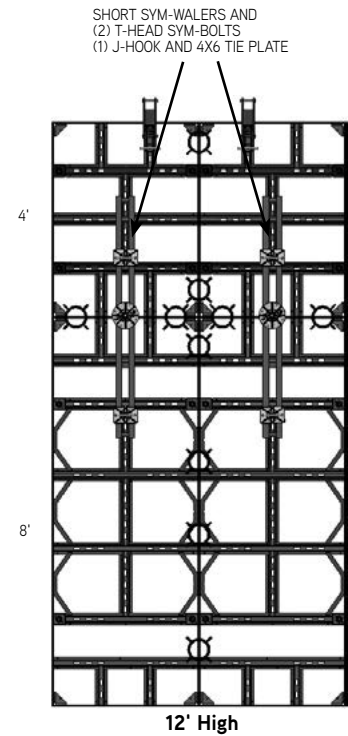
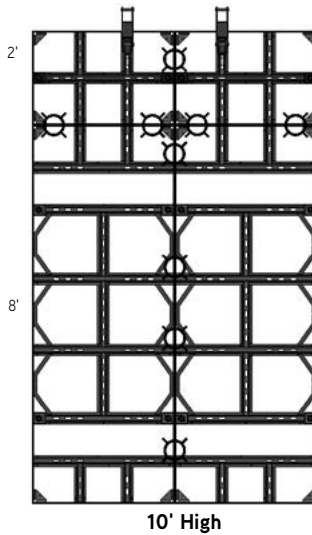
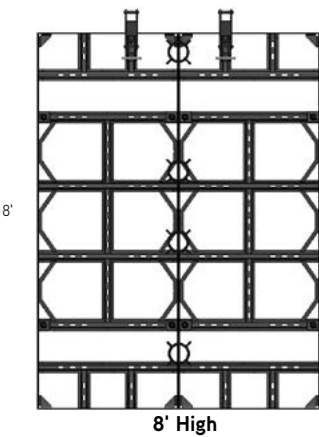
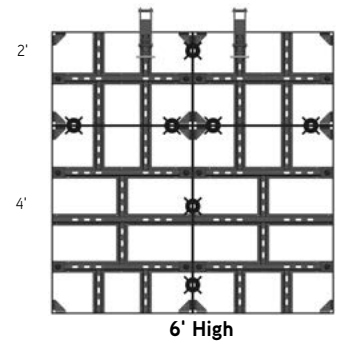
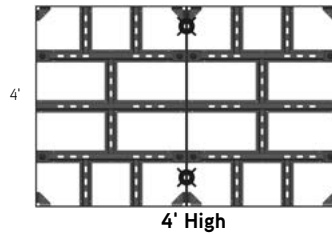
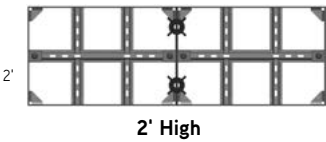

NOTES:

1. For gangs over 24' high, use 5" or 8" Versiform Walers to stiffen. Consult a Regional Engineer.
2. When using the T-Head Sym-Bolt Assembly, always be sure that the T-Handle is perpendicular to the slot length and the T-Head is fully engaged. Then hand-tighten the wing nut plus a quarter turn.
3. Crossed circle (⊗) in drawings indicates Sym-Clamp location.

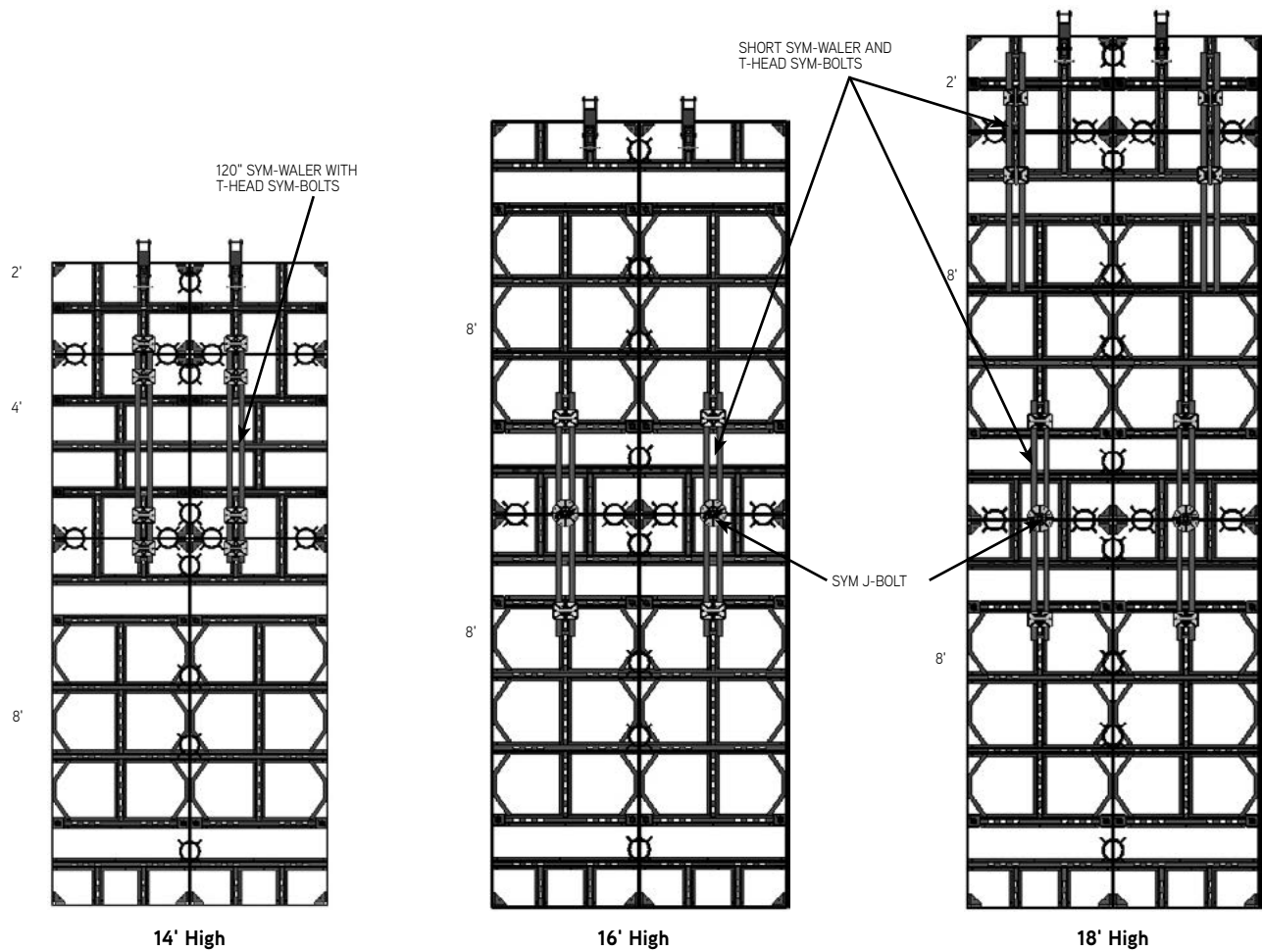

Stacking Panels with Sym-Walers, continued

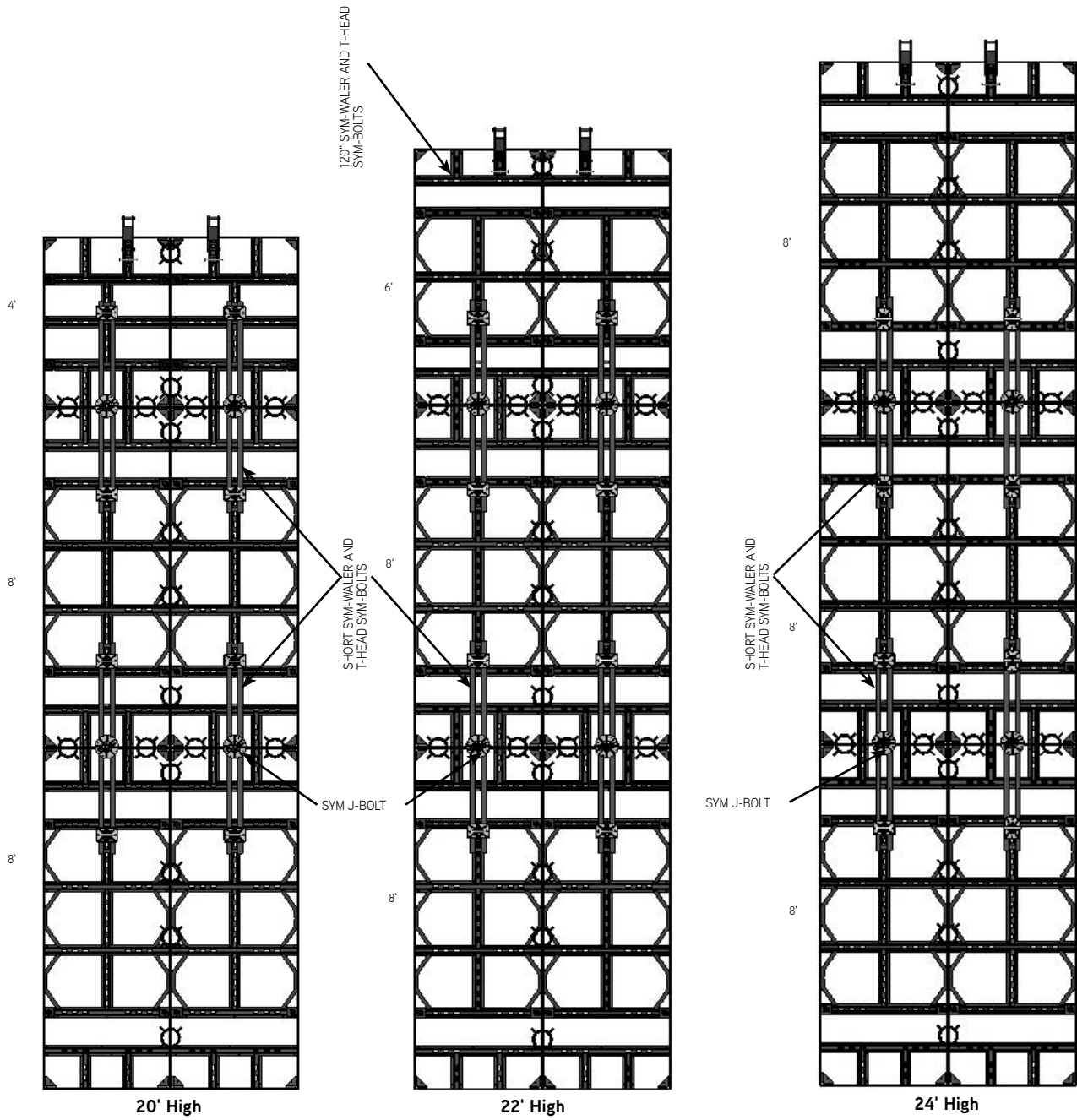

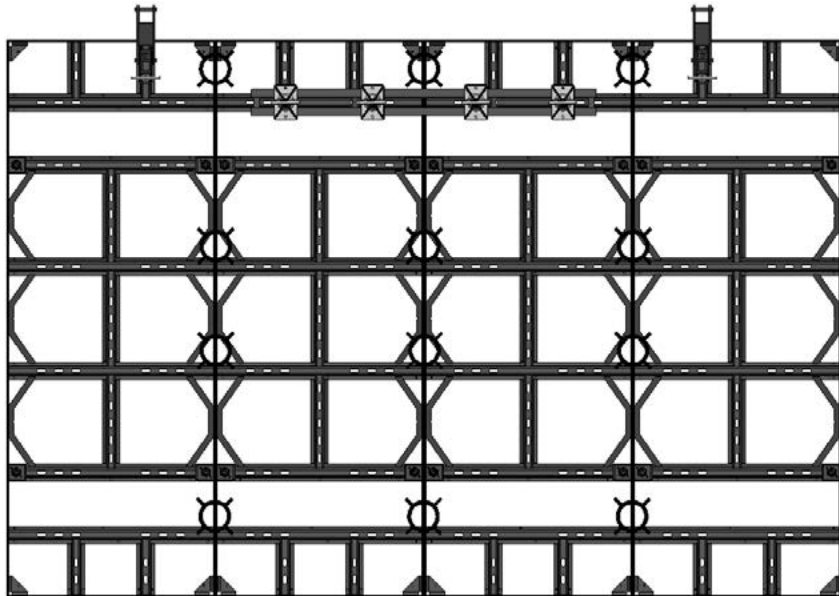

GANG – 3'-0" Wide x 8'-0" High x 4 Panels Wide

- Lift Bracket locations help prevent excessive flex during front or back picks.
- Horizontal water prevents excess flex when laying panels on back (use 4 T-Head Sym-Bolts).
- One row of clamps must be placed at the very top edge at panel joints.

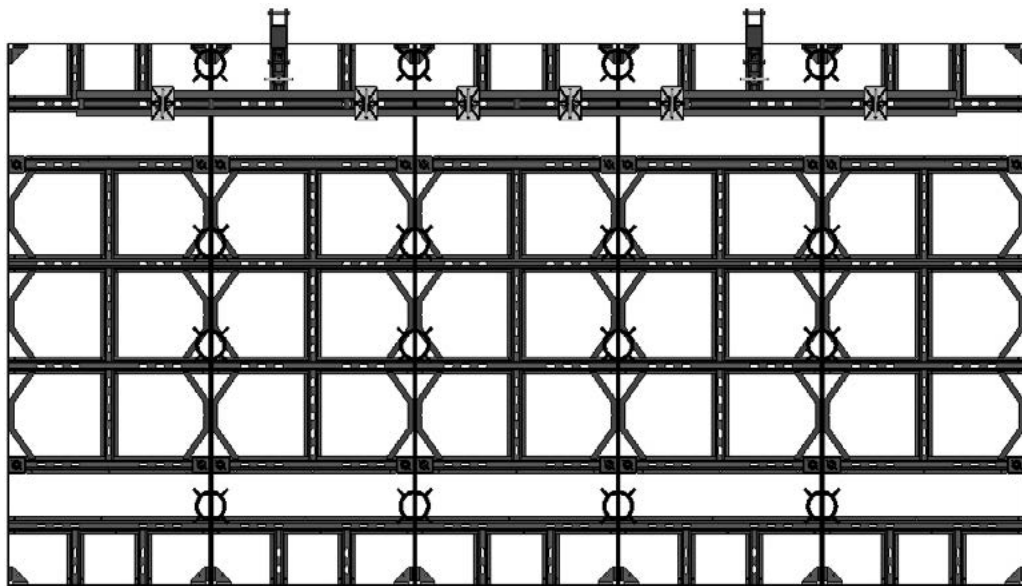

GANG – 3'-0" Wide x 8'-0" High x 5 Panels Wide

- Lift Bracket locations help prevent excessive flex during front or back picks.
- Horizontal water prevents excess flex when laying panels on back (use 6 T-Head Sym-Bolts).
- One row of clamps must be placed at the very top edge at panel joints.

Sym-Ply Gang Options with Sym-Waler, continued

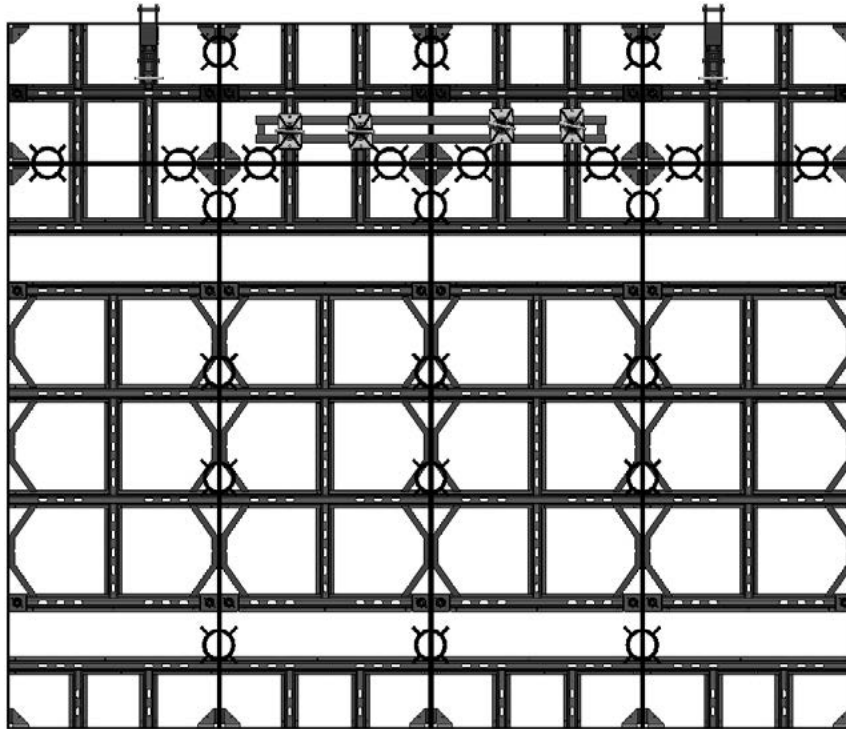

GANG – 3'-0" Wide x 8'-0" High + 2'-0" High x 4 Panels Wide

- Lift Bracket locations help prevent excessive flex during front or back picks.
- Horizontal waler prevents excess flex when laying panels on back (use 4 T-Head Sym-Bolts).
- One row of clamps must be placed at the very top edge at panel joints.

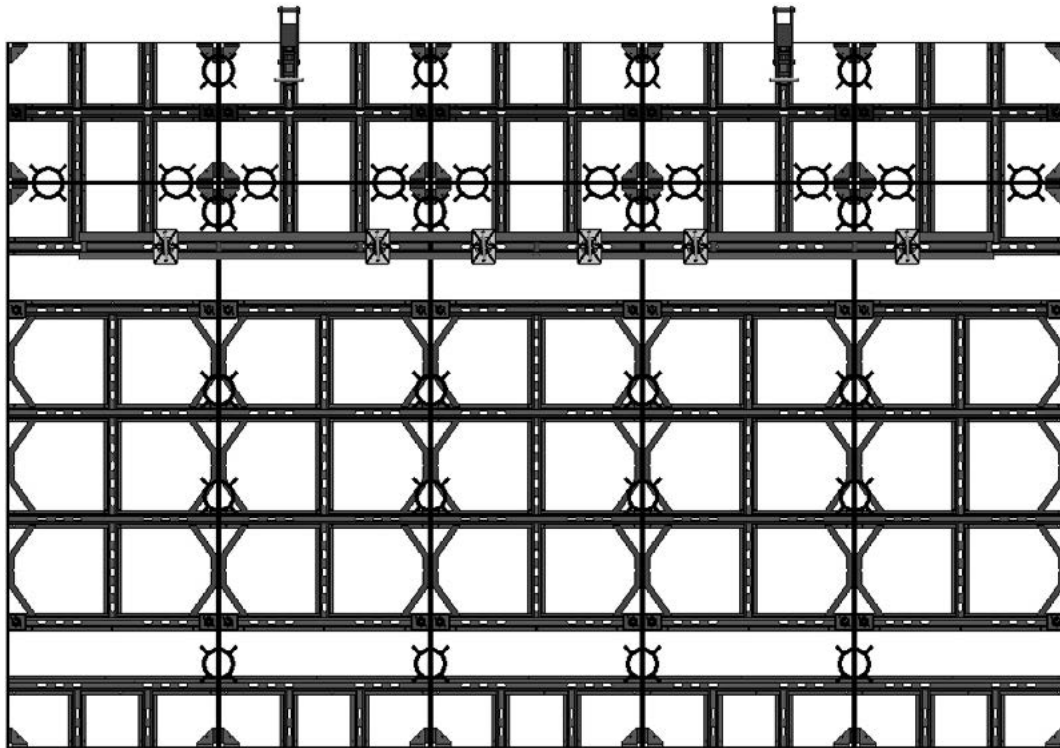

GANG – 3'-0" Wide x 8'-0" High + 2'-0" High x 5 Panels Wide

- Lift Bracket locations help prevent excessive flex during front or back picks.
- Horizontal waler prevents excess flex when laying panels on back (use 6 T-Head Sym-Bolts).
- One row of clamps must be placed at the very top edge at panel joints.

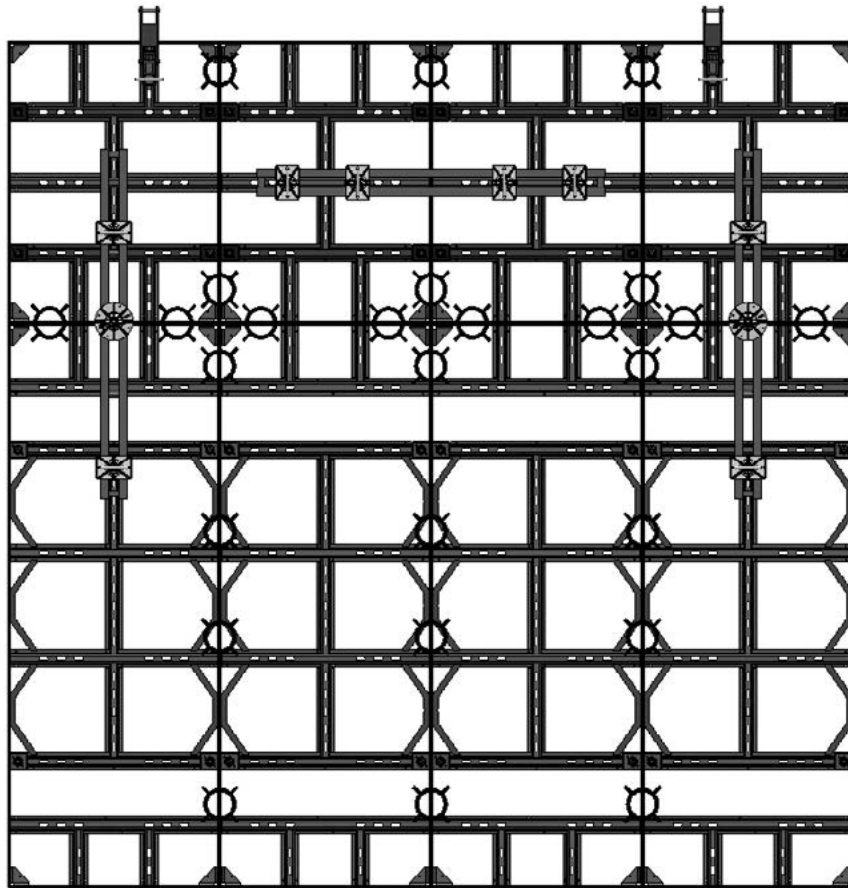

GANG – 3'-0" Wide x 8'-0" High + 4'-0" High x 4 Panels Wide

- Lift Bracket locations help prevent excessive flex during front or back picks.
- Horizontal waler prevents excess flex when laying panels on back (use 4 T-Head Sym-Bolts).
- One row of clamps must be placed at the very top edge at panel joints.

Sym-Ply Gang Options with Sym-Waler, continued

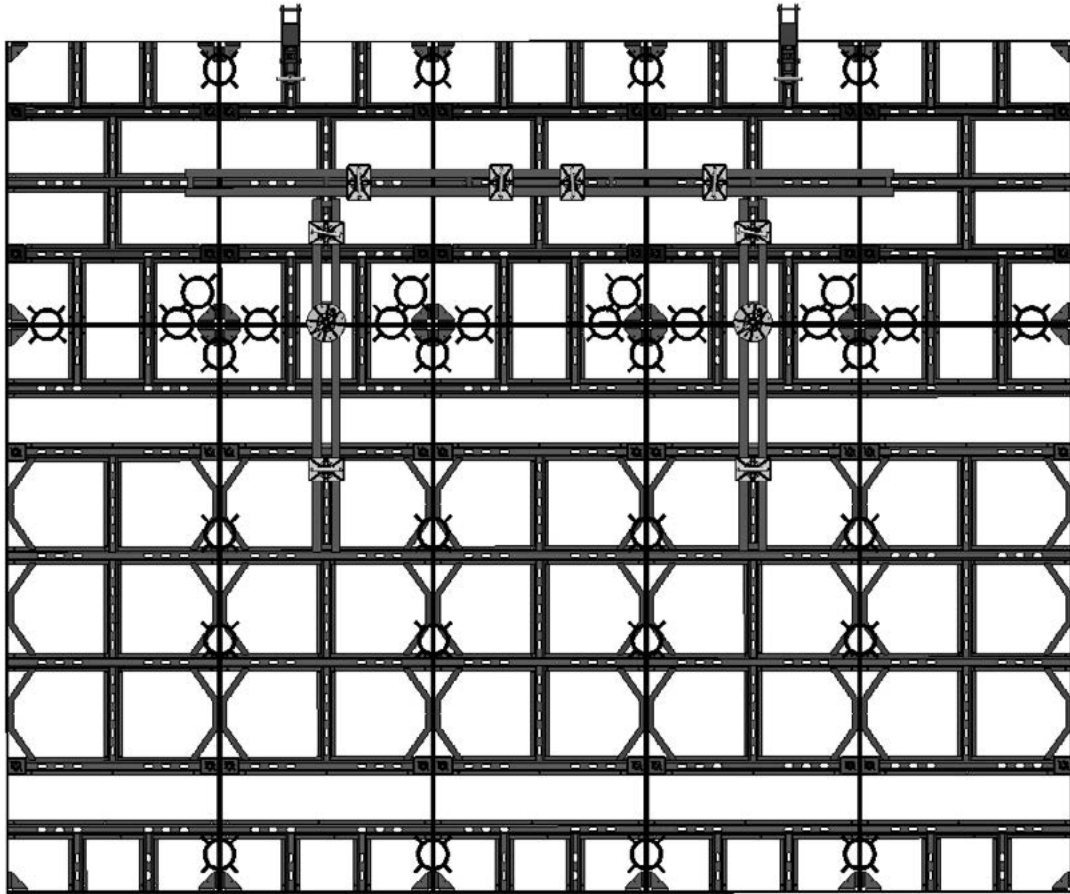

GANG — 3'-0" Wide x 8'-0" High + 4'-0" High x 5 Panels Wide

- Lift Bracket locations help prevent excessive flex during front or back picks.
- 120" Horizontal waler prevents excess flex when laying panels on back (use 4 T-Head Sym-Bolts).
- One row of clamps **must** be placed at the very top edge at panel joints.
- Vertical walers are shifted down slightly to allow room for horizontal walers.

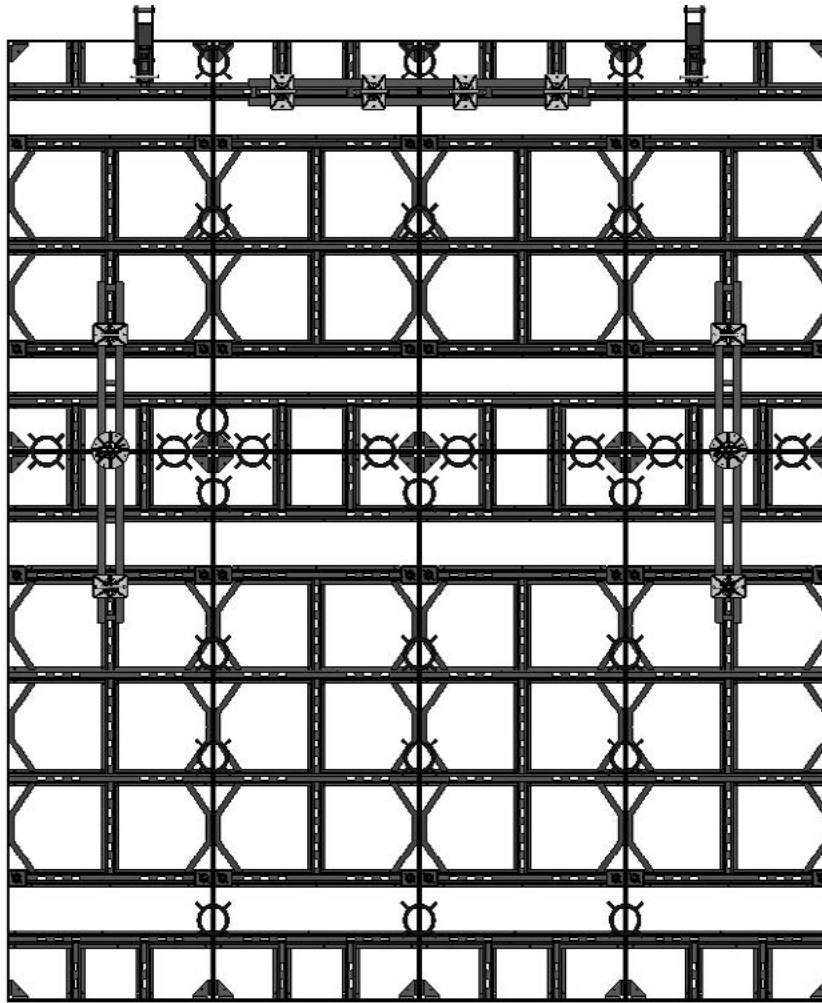

GANG – 3'-0" Wide x 8'-0" High + 6'-0" High x 4 Panels Wide

- Lift Bracket locations help prevent excessive flex during front or back picks.
- Horizontal water prevents excess flex when laying panels on back (use 4 T-Head Sym-Bolts).
- One row of clamps **must** be placed at the very top edge at panel joints.
- Vertical short Sym-Walers cover the horizontal panel joints.

Sym-Ply Gang Options with Sym-Waler, continued

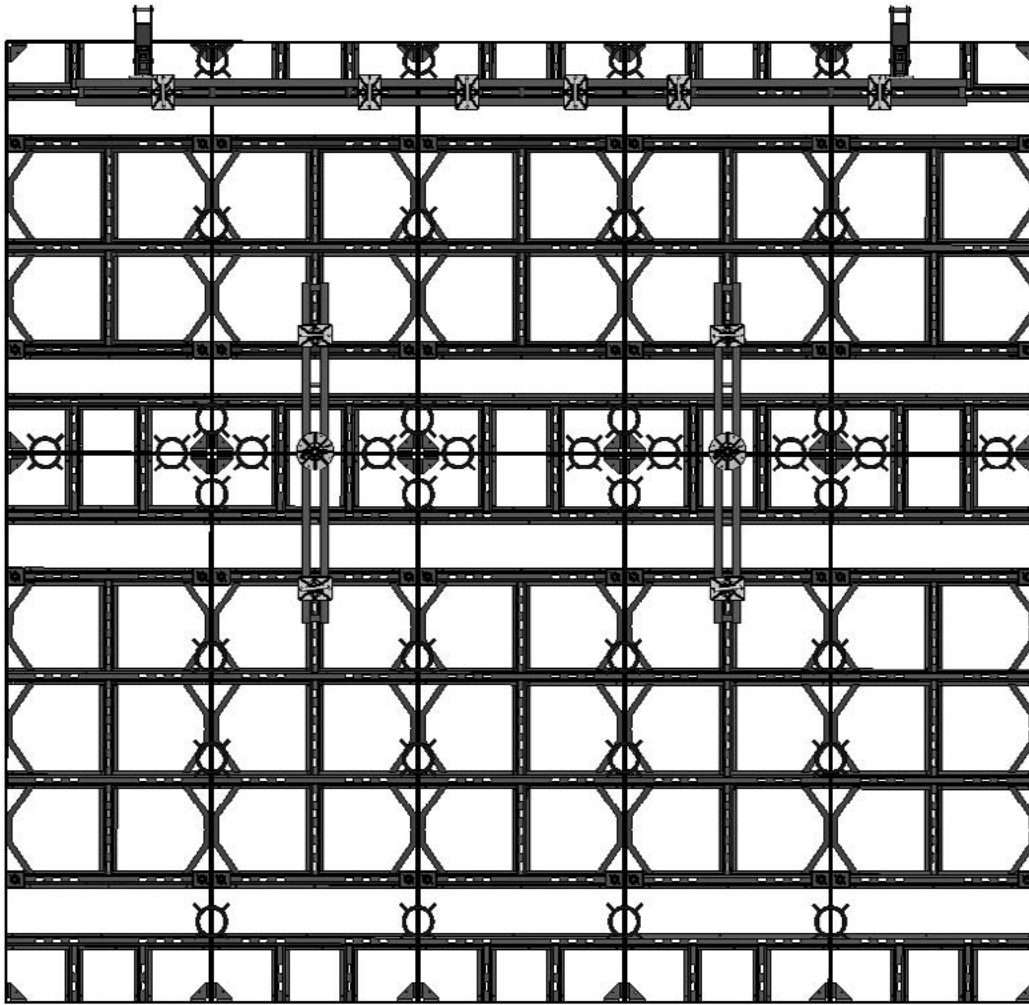

GANG – 3'-0" Wide x 8'-0" High + 6'-0" High x 5 Panels Wide

- Lift Bracket locations help prevent excessive flex during front or back picks.
- 120" horizontal Sym-Waler prevents excess flex when laying panels on back (use 6 T-Head Sym-Bolts).
- One row of clamps **must** be placed at the very top edge at panel joints.
- Vertical short Sym-Walers cover the horizontal panel joints.

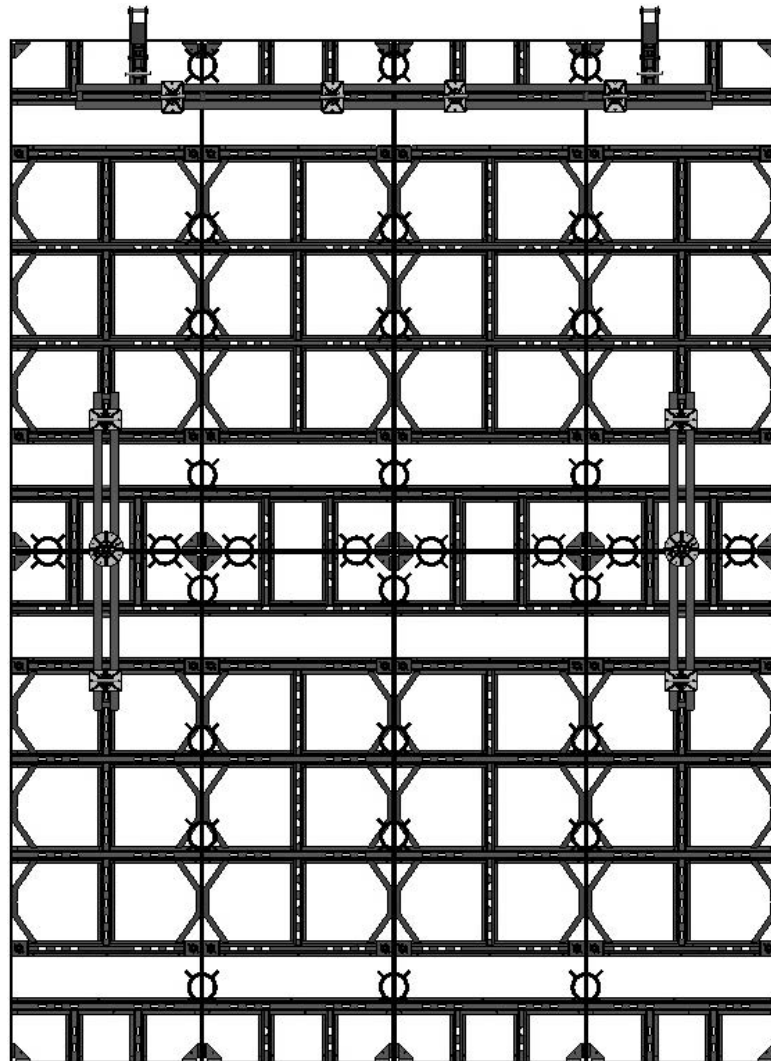

GANG — 3'-0" Wide x 8'-0" High + 8'-0" High x 4 Panels Wide

- Lift Bracket locations help prevent excessive flex during front or back picks.
- Horizontal water prevents excess flex when laying panels on back (use 4 T-Head Sym-Bolts).
- One row of clamps **must** be placed at the very top edge at panel joints.

Sym-Ply Gang Options with Sym-Waler, continued

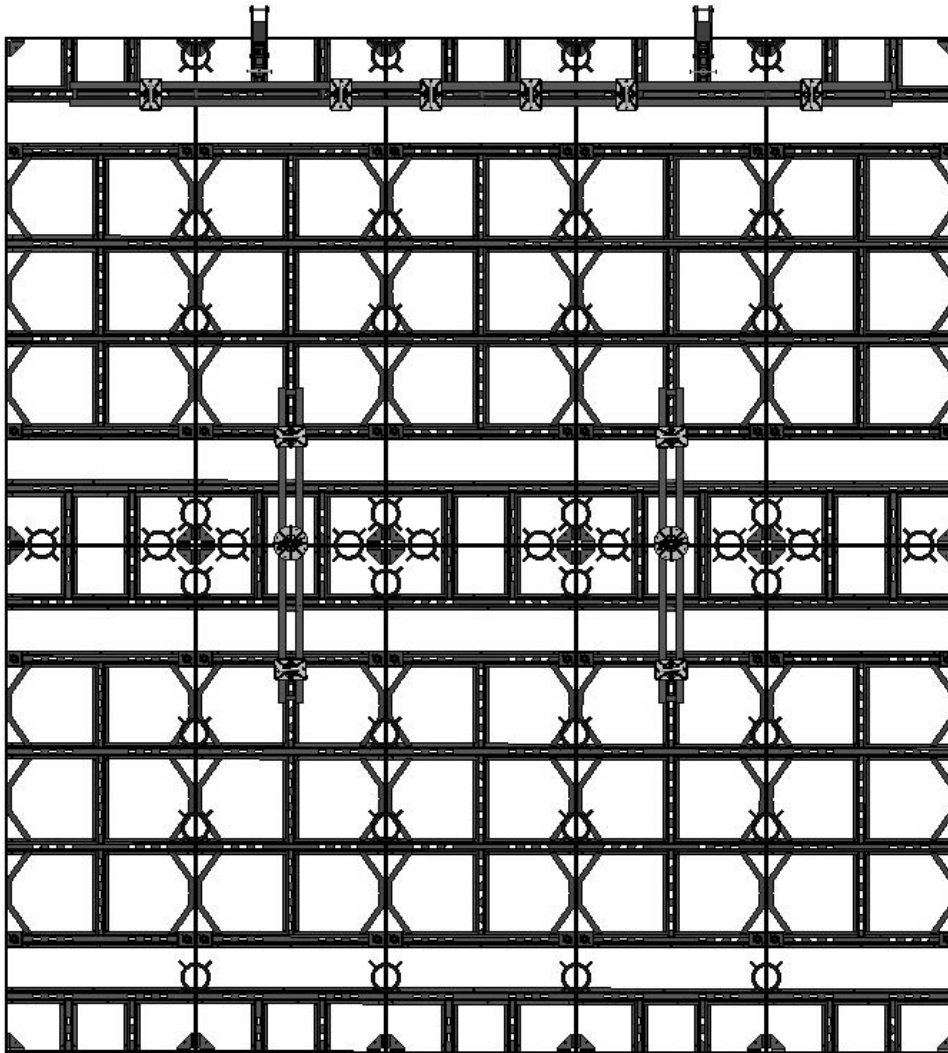

GANG – 3'-0" Wide x 8'-0" High + 8'-0" High x 5 Panels Wide

- Lift Bracket locations help prevent excessive flex during front or back picks.
- 120" long horizontal Sym-Waler prevents excess flex when laying panels on back (use 6 T-Head Sym-Bolts).
- One row of clamps **must** be placed at the very top edge at panel joints.

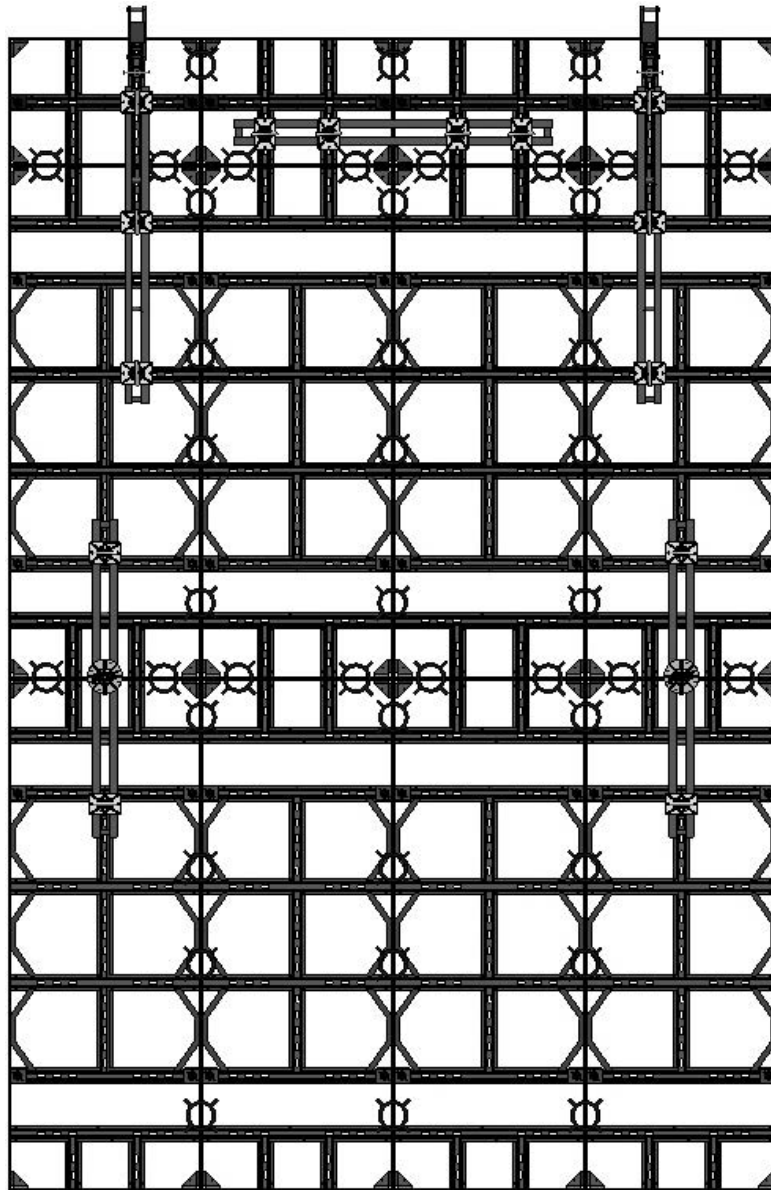

GANG – 3'-0" Wide x 8'-0" High + 8'-0" + 2'-0" High x 4 Panels Wide

- Lift Bracket locations help prevent excessive flex during front or back picks.
- Horizontal waler prevents excess flex when laying panels on back (use 4 T-Head Sym-Bolts).
- One row of clamps **must** be placed at the very top edge at panel joints.
- Top vertical walers are shifted down as shown.

Sym-Ply Gang Options with Sym-Waler, continued

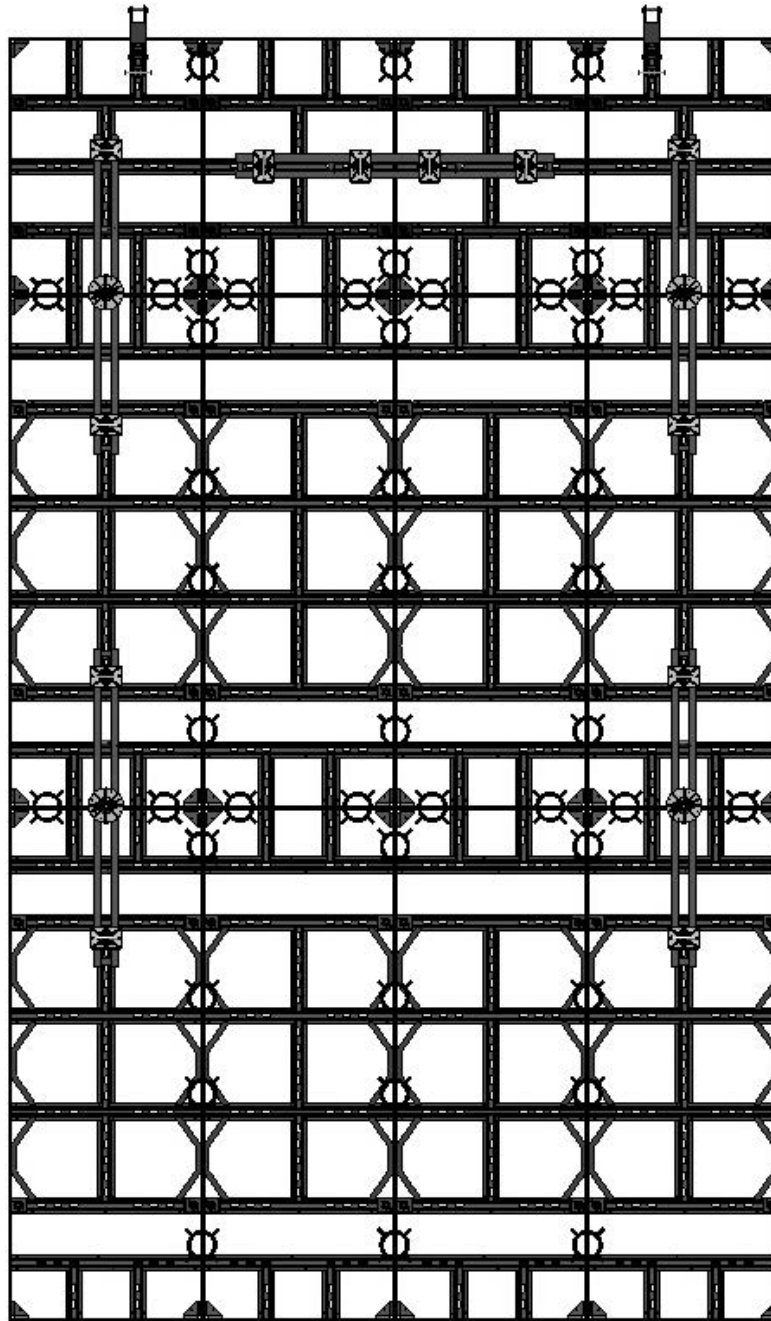

GANG – 3'-0" Wide x 8'-0" High + 8'-0" High + 4'-0" High x 4 Panels Wide

- Lift Bracket locations help prevent excessive flex during front or back picks.
- 60" long horizontal Sym-Waler prevents excess flex when laying panels on back (use 4 T-Head Sym-Bolts).
- One row of clamps **must** be placed at the very top edge at panel joints.

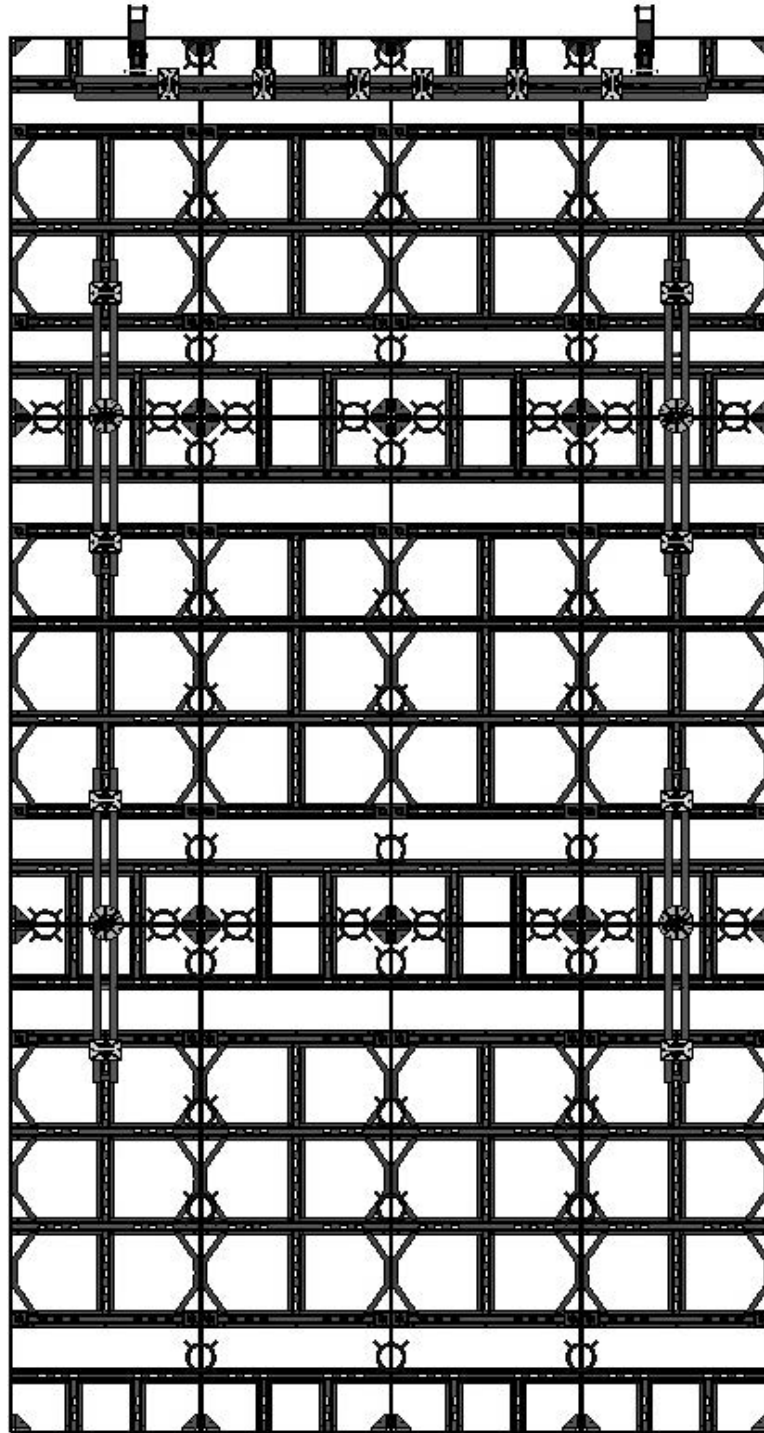

GANG — 3'-0" Wide x 8'-0" High + 8'-0" + 6'-0" High x 4 Panels Wide

- Lift Bracket locations help prevent excessive flex during front or back picks.
- 60" long Versiform horizontal waler prevents excess flex when laying panels on back (use 6 T-Head Sym-Bolts).
- One row of clamps **must** be placed at the very top edge at panel joints.
- Sym-Waler covers the horizontal panel joint.

Sym-Ply Gang Options with Sym-Waler, continued

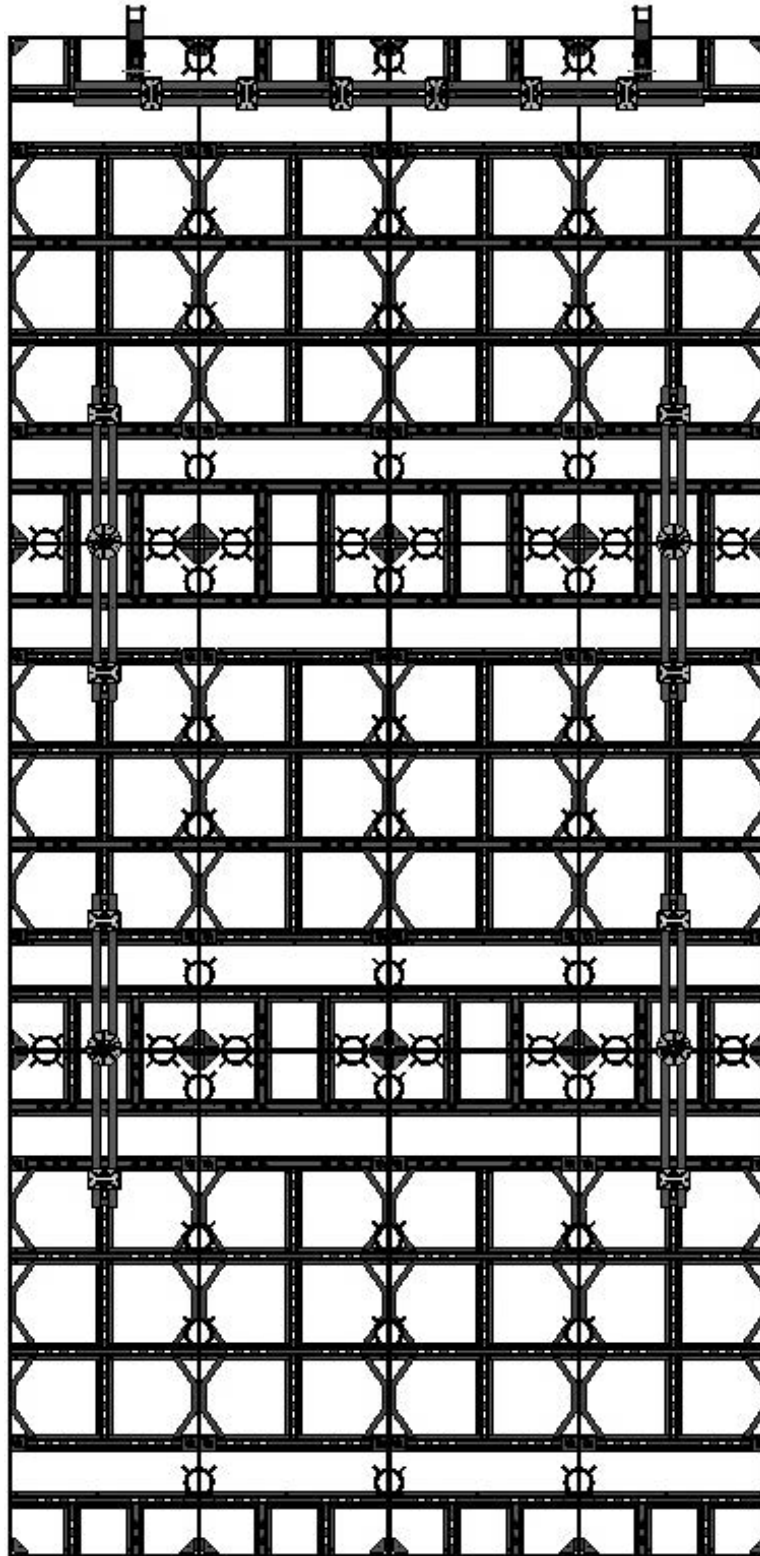

GANG – 3'-0" Wide x 8'-0" High + 8'-0" High + 8'-0" High x 4 Panels Wide

- Lift Bracket locations help prevent excessive flex during front or back picks.
- 60" long horizontal Sym-Waler prevents excess flex when laying panels on back (use 6 T-Head Sym-Bolts).
- One row of clamps **must** be placed at the very top edge at panel joints.

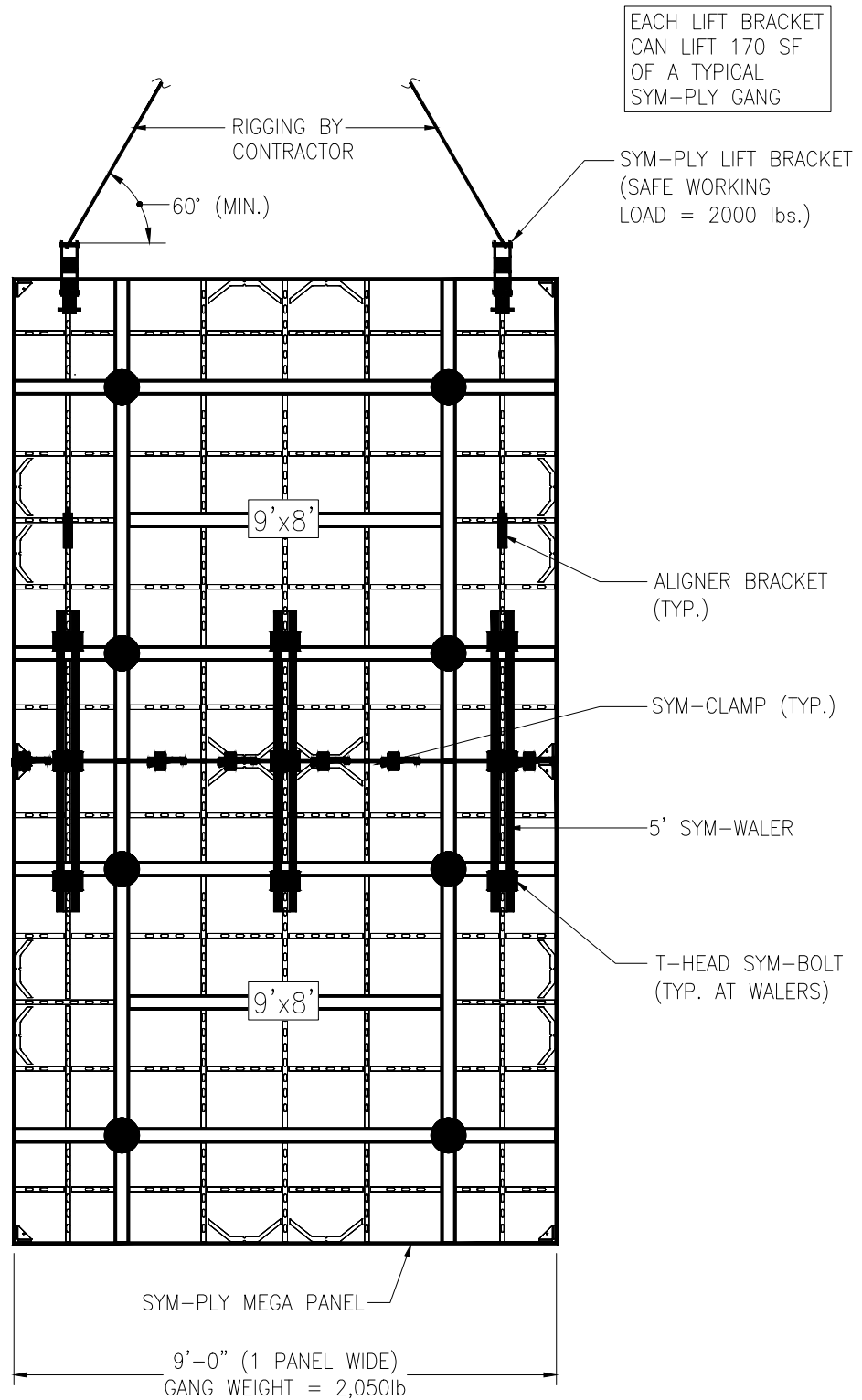

GANG - 1 Panel Wide x 2 Panels Tall - Part#: F56000 (9' Wide x 8' Tall)

- Lift Bracket locations help prevent excessive flex during front or back picks.
- 60" long horizontal Sym-Waler prevents excess flex when laying panels on back (use 6 T-Head Sym-Bolts).
- One row of clamps **must** be placed at the very top edge at panel joints.

Sym-Ply Gang Options with Sym-Waler, continued

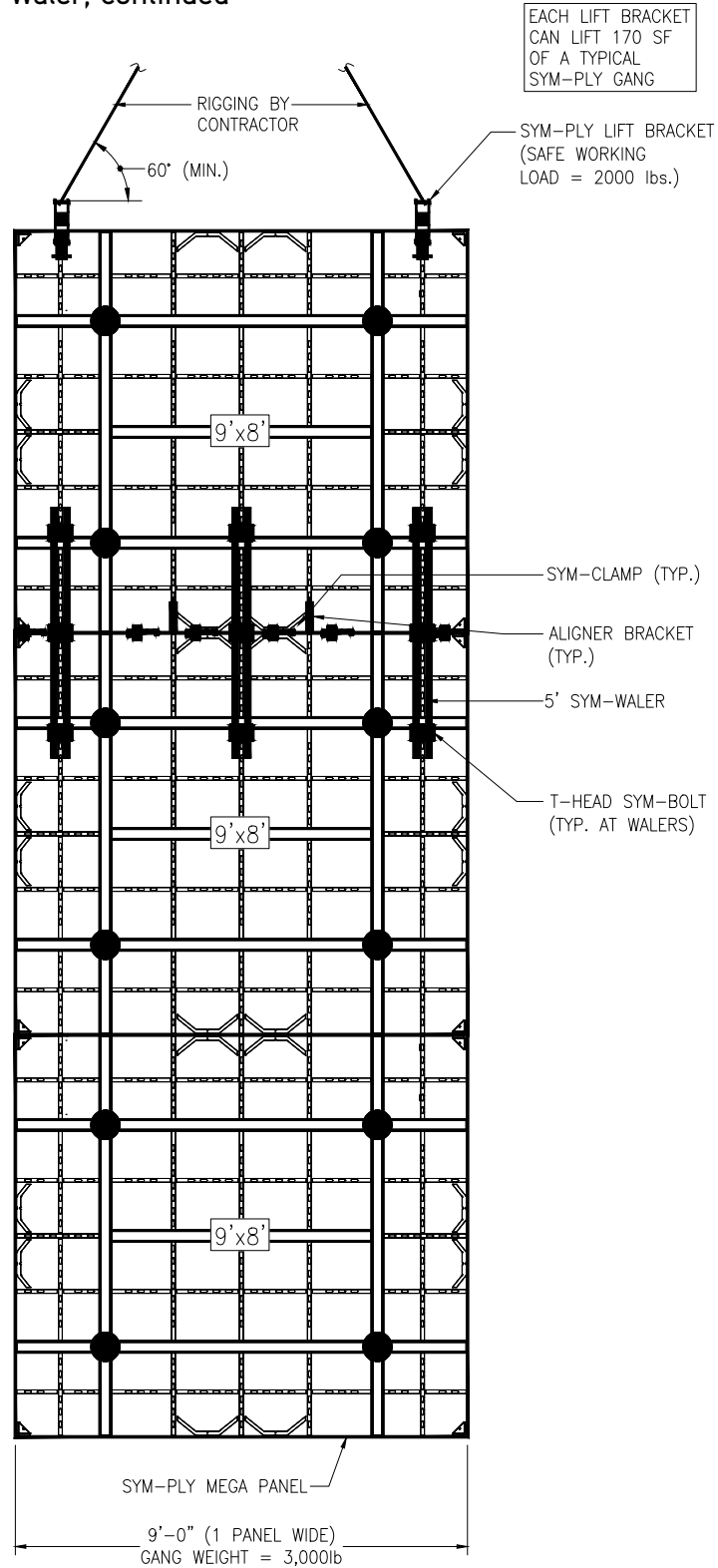

GANG - 1 Panel Wide x 3 Panels Tall - Part#: F56000 (9' Wide x 8' Tall)

- Lift Bracket locations help prevent excessive flex during front or back picks.
- 60" long horizontal Sym-Waler prevents excess flex when laying panels on back (use 6 T-Head Sym-Bolts).
- One row of clamps **must** be placed at the very top edge at panel joints.

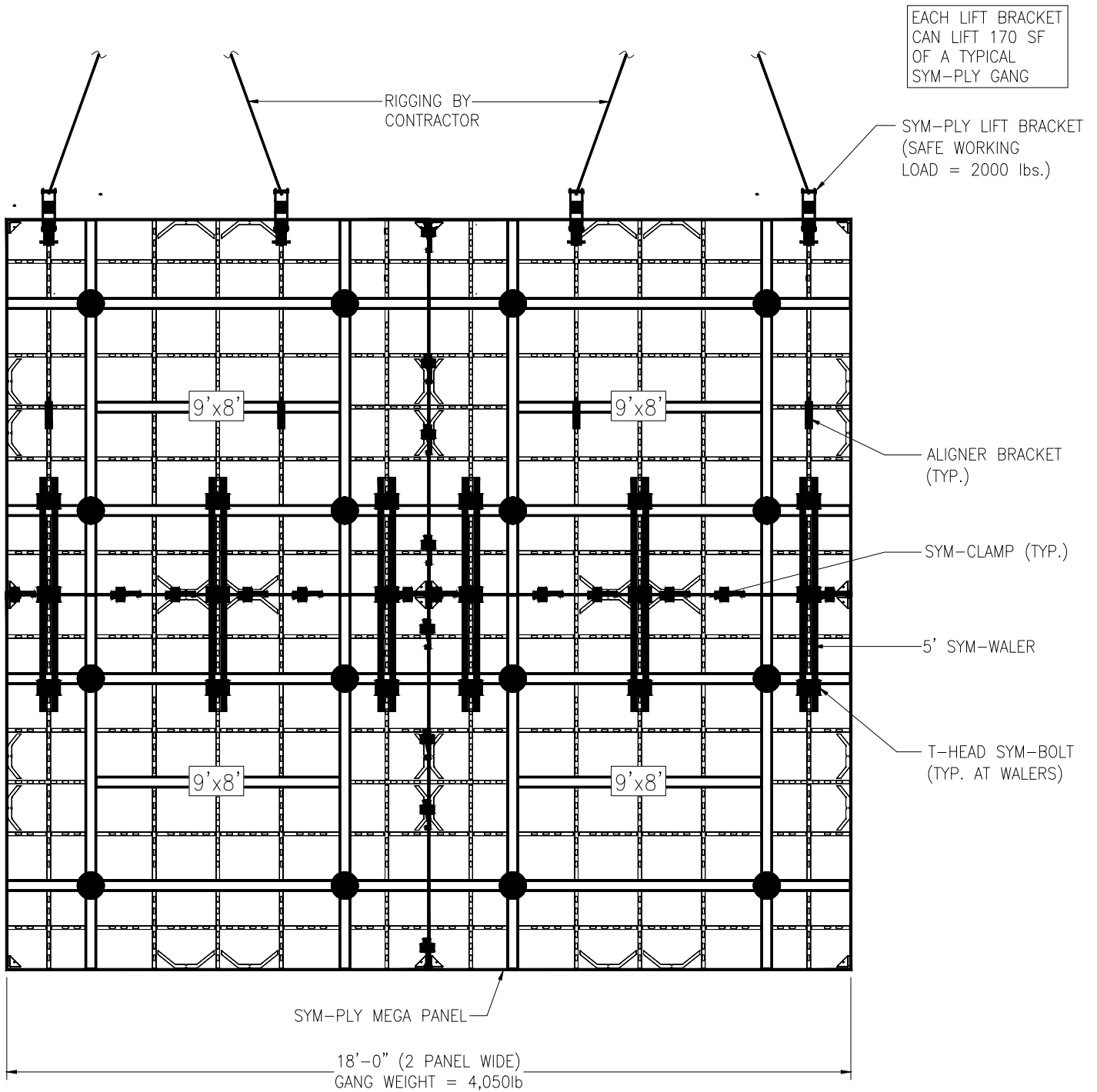

EACH LIFT BRACKET CAN LIFT 170 SF OF A TYPICAL SYM-PLY GANG

SYM-PLY LIFT BRACKET (SAFE WORKING LOAD = 2000 lbs.)

ALIGNER BRACKET (TYP.)

SYM-CLAMP (TYP.)

5' SYM-WALER

T-HEAD SYM-BOLT (TYP. AT WALERS)

SYM-PLY MEGA PANEL

18'-0" (2 PANEL WIDE)
GANG WEIGHT = 4,050lb

GANG - 2 Panels Wide x 2 Panels Tall - Part#: F56000 (9' Wide x 8' Tall)

- Lift Bracket locations help prevent excessive flex during front or back picks.
- 60" long horizontal Sym-Waler prevents excess flex when laying panels on back (use 6 T-Head Sym-Bolts).
- One row of clamps **must** be placed at the very top edge at panel joints.

Sym-Ply Gang Options with Sym-Waler, continued

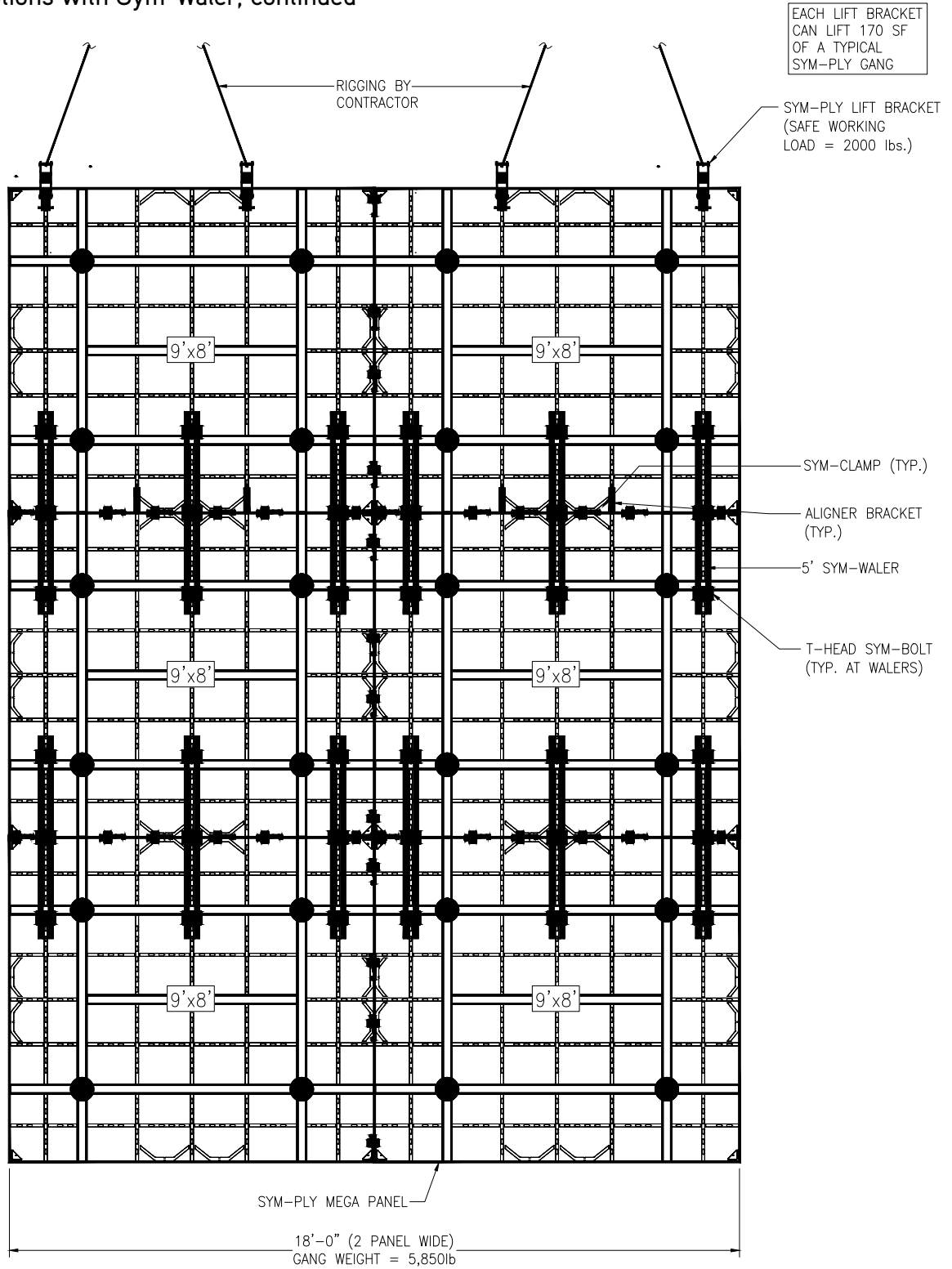

GANG - 2 Panels Wide x 3 Panels Tall - Part#: F56000 (9' Wide x 8' Tall)

- Lift Bracket locations help prevent excessive flex during front or back picks.
- 60" long horizontal Sym-Waler prevents excess flex when laying panels on back (use 6 T-Head Sym-Bolts).
- One row of clamps **must** be placed at the very top edge at panel joints.

Corner and Bulkhead Details

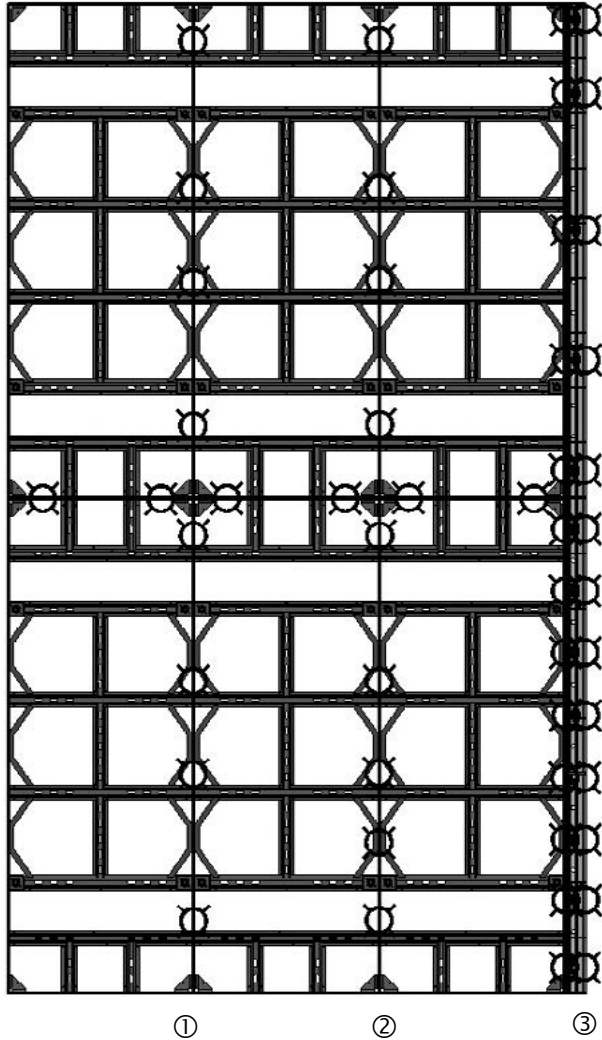

Corner and Bulkhead Clamp Spacing
(for Panel Widths of 3' and 2'-6")

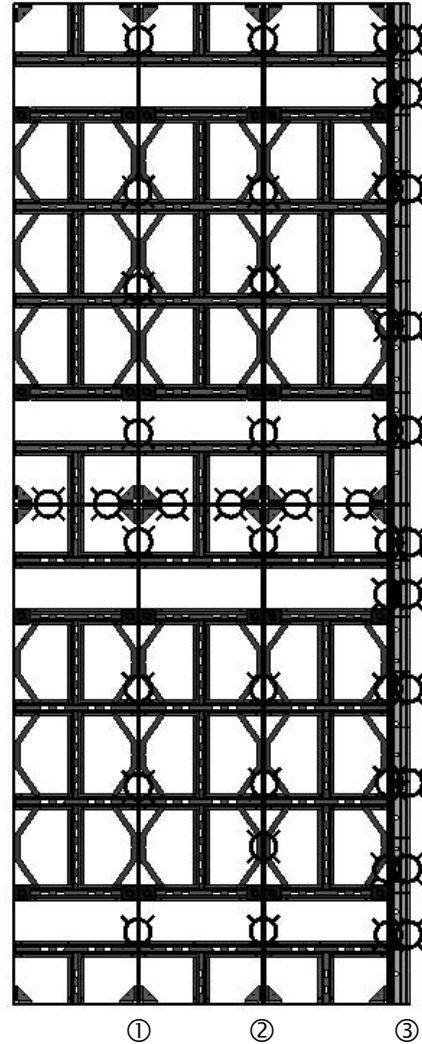

Corner and Bulkhead Clamp Spacing
(for Panel Widths of 2' and Less)

- ① Typical interior joint
- ② First joint from Outside Corner or bulkhead
- ③ Joint at Outside Corner

CAUTION: For wall thicknesses greater than 23", consult your Regional Engineering Manager.

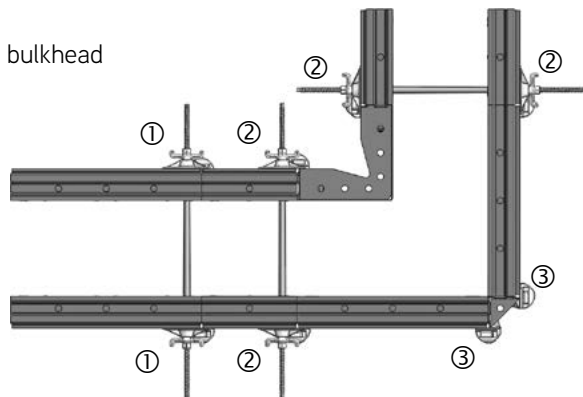

Clamps near Outside Corners or Bulkheads

Corner and Column Details

Sym-Ply Version 1

Version 1 of Sym-Ply was manufactured up to August of 2012. While this version has the same 1500psf capacity, use in columns and corners should be handled in the methods shown in the renderings to follow. Version 1 can easily be identified in several ways:

1. In panels 18" and wider, the vertical cross-member runs continuous
2. In panels 24" and wider, Version 1 utilizes a tie-off bar located between side rails and vertical cross-members
3. The tie-box of Version 1 is a solid formed box which goes down to the plastic tie-plate on the back side of the form.

Sym-Ply Version 2

Version 2 of Sym-Ply was manufactured after August of 2012. Version 2 can be identified in several ways:

1. In panels 18" and wider, the vertical cross-member does not run continuous
2. In all panels, Version 2 utilizes slots punched in the "legs" of the cross-members for tie-off points. There are NO tie-off bars.
3. The tie-box of Version 2 has cut-outs near the plastic tie plates.



Version 1
3'Wide x 8' High Panel



Version 2
3'Wide x 8' High Panel

CAUTION: Columns and corners exert extreme loads on forming equipment. Both tension and shear are transferred into panel connections in these applications. Designs should accommodate and properly support these loads.

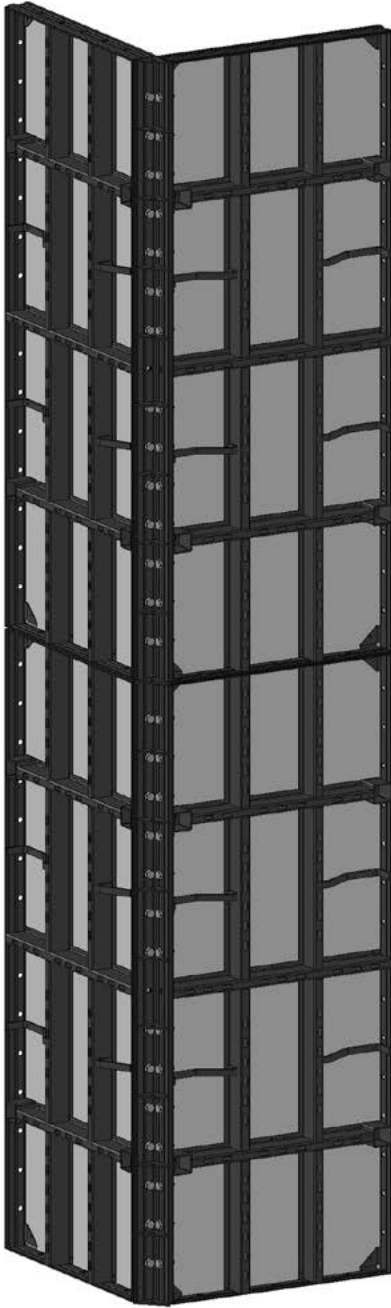

Application #1

Sym-Ply Version 1 to Sym-Ply Version 1

When connecting Version 1 to Version 1, Wedge Bolts or $\frac{3}{4}$ " Speed Bolts and Nuts should be placed at every usable hole location as shown in the rendering.

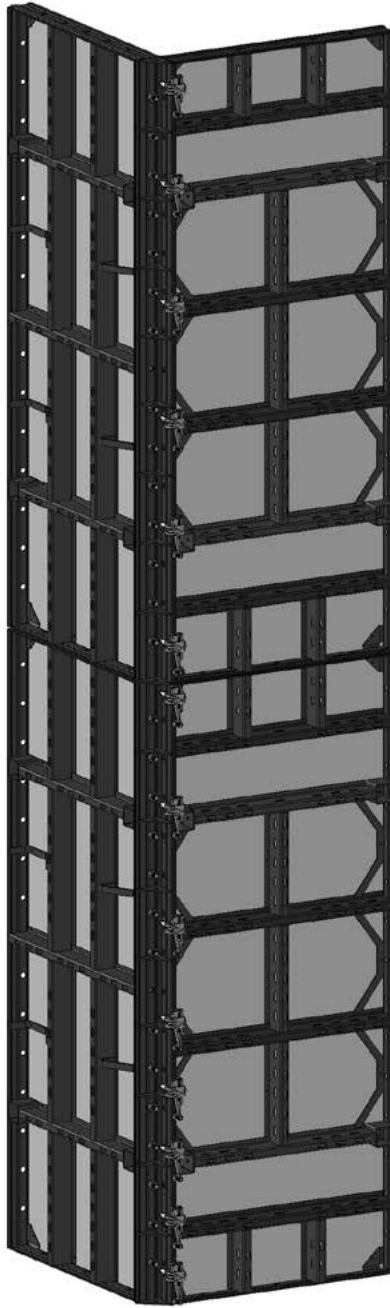

Application #2

Sym-Ply Version 1 to Sym-Ply Version 2

When connection Version 1 to Version 2, Wedge Bolts or $\frac{3}{4}$ " Speed Bolts and Nuts should be placed at every usable hole location at the Version 1 panel connection. Sym-Clamps can be used on the Version 2 panel connection as shown. Where the concrete pressure exceeds 1,200psf clamps shall be placed one (1) foot on center. Contact your Dayton Regional Engineering Manager with questions or concerns.

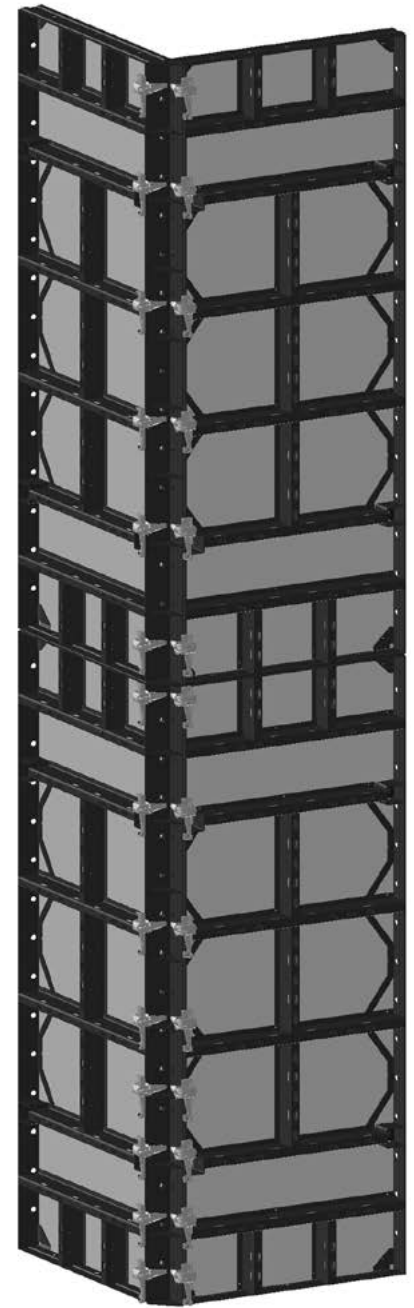

Application #3

Sym-Ply Version 2 to Sym-Ply Version 2

The connection for Version 2 to Version 2 can be done using Sym-Clamps as shown. Where the concrete pressure exceeds 1,200psf clamps shall be placed one (1) foot on center. Contact your Dayton Regional Engineering Manager with questions or concerns.

Typical Details

Corner with Fillers

Wall Thickness (inches)	Panel Width (inches)	Filler Width (inches)
8	24	4
10	24	2
12	24	0
14	30	4
16	30	2
18	30	0
20	36	4
22	36	2
24	36	0

Wall Thickness (inches)	Panel Width (inches)	Filler Width (inches)
4	12	4
12	24	0
14	24	2
16	24	4
18	30	0
20	30	2
22	30	4
24	36	0
26	36	2
28	36	4

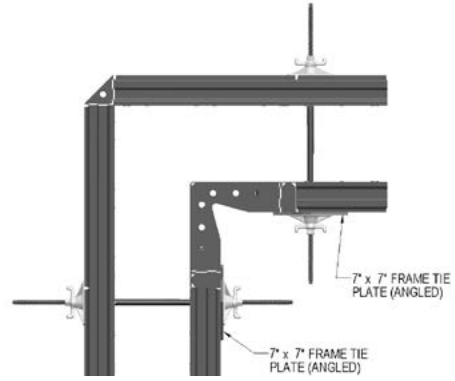

90° Corner with Fillers at Inside Corner

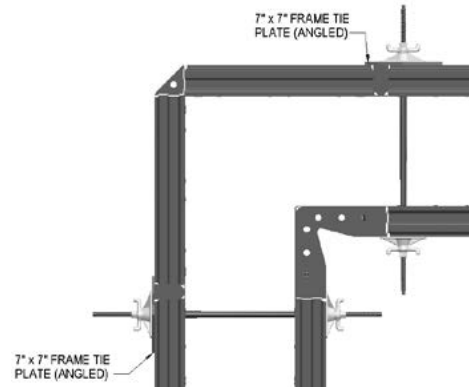

90° Corner with Fillers at Outside Corner

T-Wall Detail

Wall Thickness (inches)	Panel Width (inches)	Filler Width (inches)
6	30	0
8	30	2
10	30	3
12	24	0
14	36	2
16	36	4
18	36	6
20	36	8

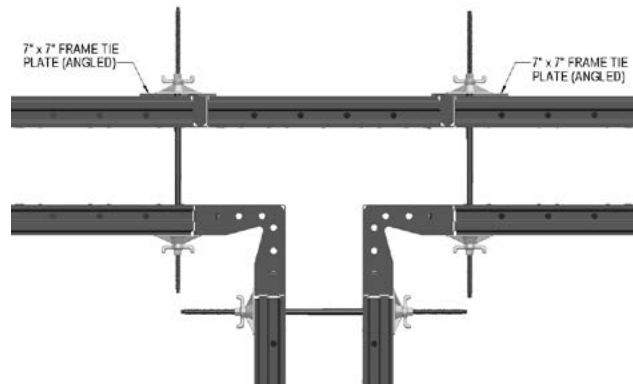

Typical T-Wall with Fillers

NOTE: When using fillers, ensure the tie plate bears on both panel rails on either side of the filler. The use of a 7"x7" tie plate, waler, or additional ties may be necessary. Consult your Regional Engineer for additional information.

Non-Perpendicular Corners

Non-perpendicular corners can be easily formed with standard Steel-Ply Hinged Corners. Because Sym-Ply connects directly to Steel-Ply, Wedge Bolts can be used for a “no hassle” connection.

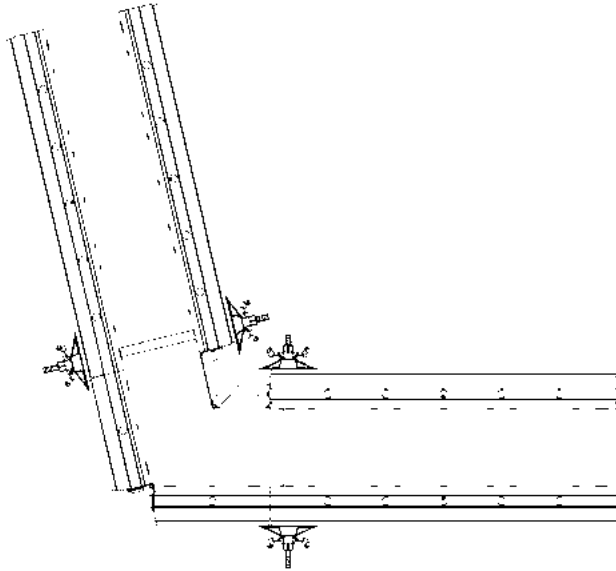

Non-Perpendicular Corner with Steel-Ply Hinged Corners

Taper Ties and She-Bolts

Taper Ties with 15mm or 20mm thread can be used with Sym-Ply.

Typically, the ties should pass through the larger of two adjacent panels, and unused tie holes are plugged.

IMPORTANT: Note taper direction for setting and stripping.

(For clarity, clamps are not shown in these drawings.)

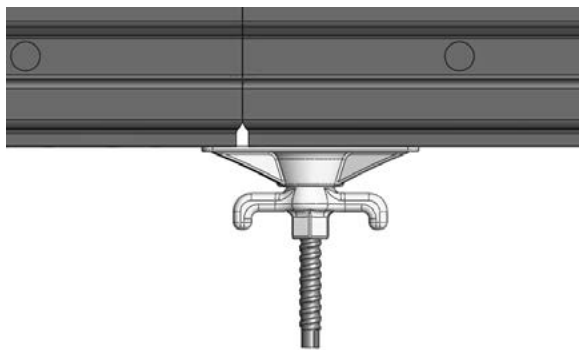

Typical Tie Placement

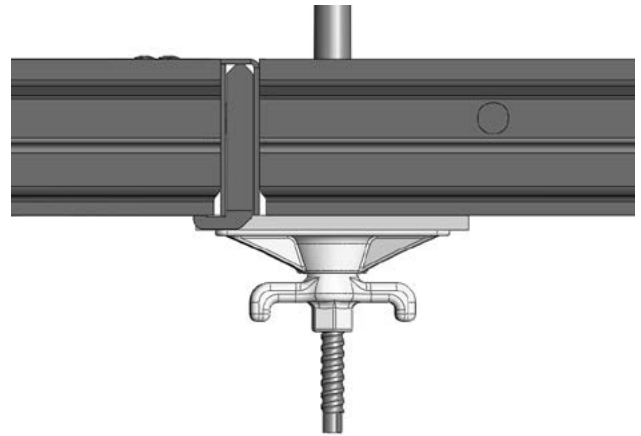

Typical Tie Placement Adjacent to 1" Filler

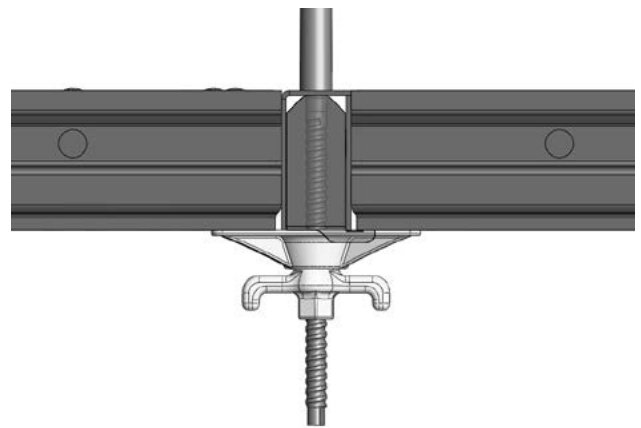

Typical Tie Placement Through 2" Filler

She Bolts

Safe working load is 18,000 lbs. at a 2:1 Safety Factor.

She Bolts with 15mm threaded inner unit are another tying option.

Use only round DCR bar-type Inner Units to avoid concrete build-up in the nose of the She Bolt.

CAUTION: Do not use with bent Inner Units!

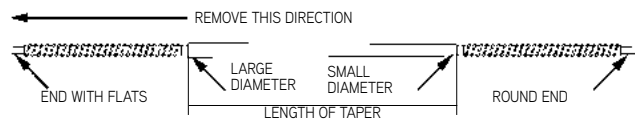

Taper Tie

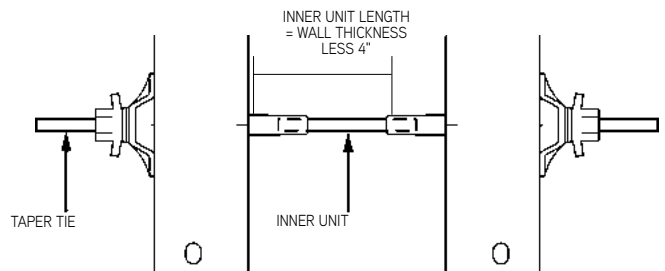

Typical She-Bolt Application

Top Tie Bracket

The Top Tie Bracket provides a tie bearing location for a dry tie at the top of a pour or bulkhead. The bracket must straddle a crossmember/endmember or tie box.



NO



YES

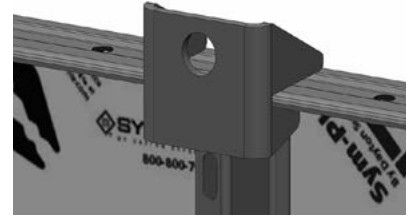

YES



NO



YES

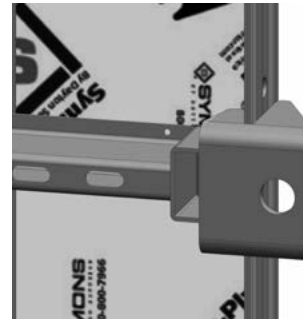

YES



Typical Top Tie Application

Bulkheads

Bulkheads are easily constructed with Sym-Walers and Bulkhead Rods using the slots in the Sym-Ply crossmembers or stiffeners. The walers support the bulkhead plywood and lumber (supplied by the contractor). Typically, walers are required 3' on center.

In addition, Top Tie Brackets can be used externally as shown. This simplifies bulkhead construction by avoiding interference with the bulkhead lumber.

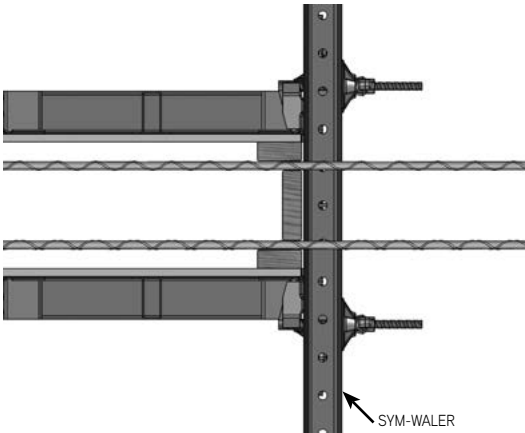

Typical Bulkhead with Sym-Waler

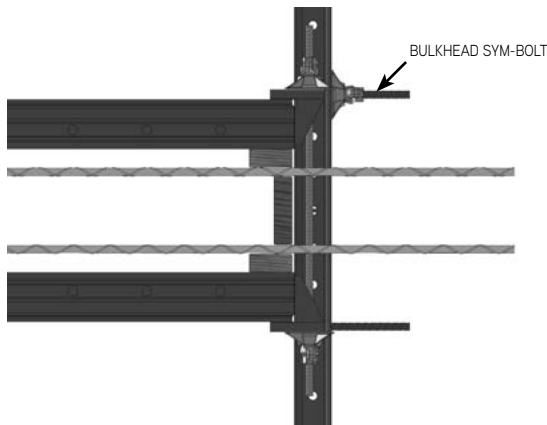

Typical Bulkhead with External Tie

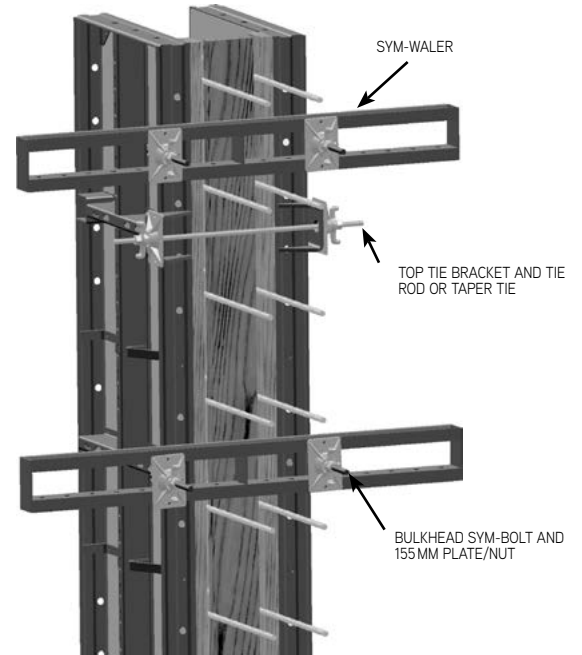

Typical Bulkhead with External Tie

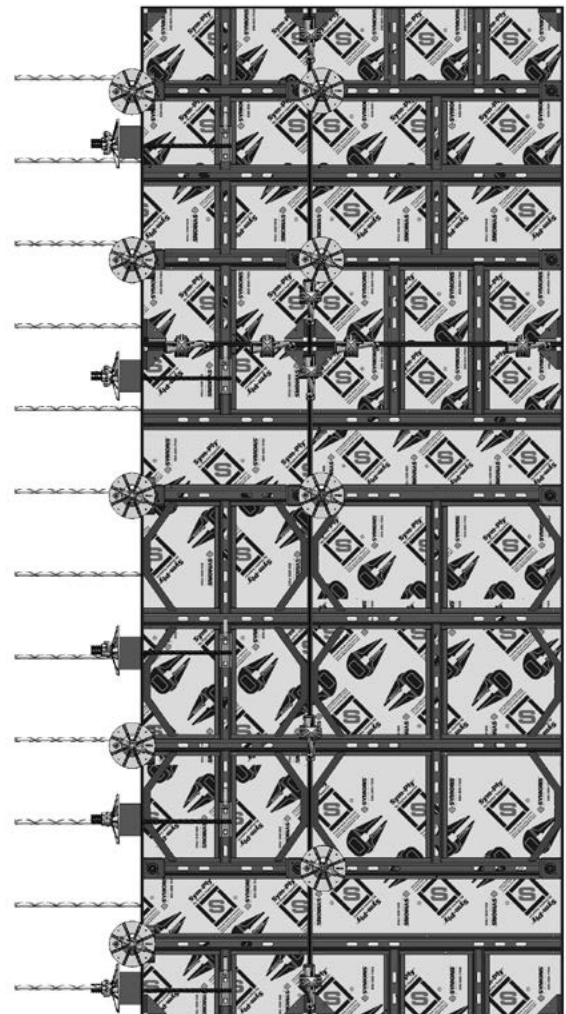

Elevation at Bulkhead

NOTE: Spacing of the Sym-Waler and Top Tie Brackets are dependent on several factors, including wall thickness and end panel size. Consult your Regional Engineer for spacing.

60" Sym-Waler

Sym-Walers stiffen gangs for common operations:

- Lifting gangs from horizontal
- Bulkhead timber support
- Aligning gangs across a job-built filler (see next section)
- Supporting Slip Plates



Stiffen Gangs with Sym-Waler
(See Stacking Panels section for locations)

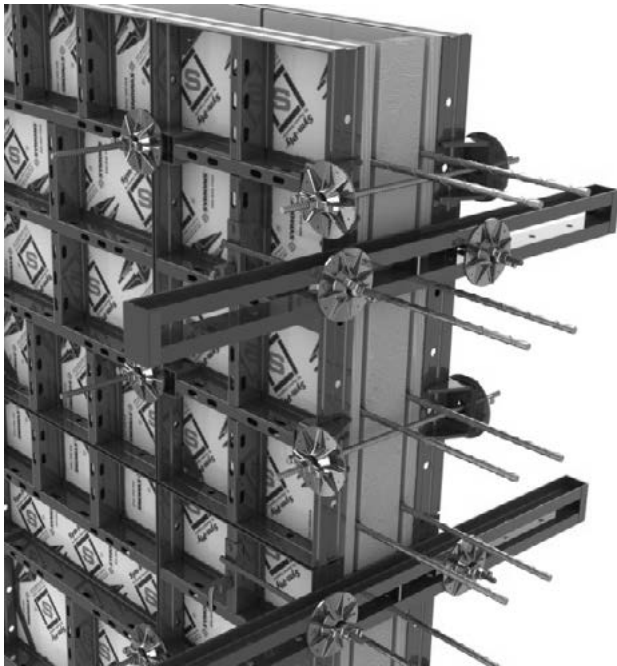

Bulkhead with Sym-Waler

Stacking Clamp

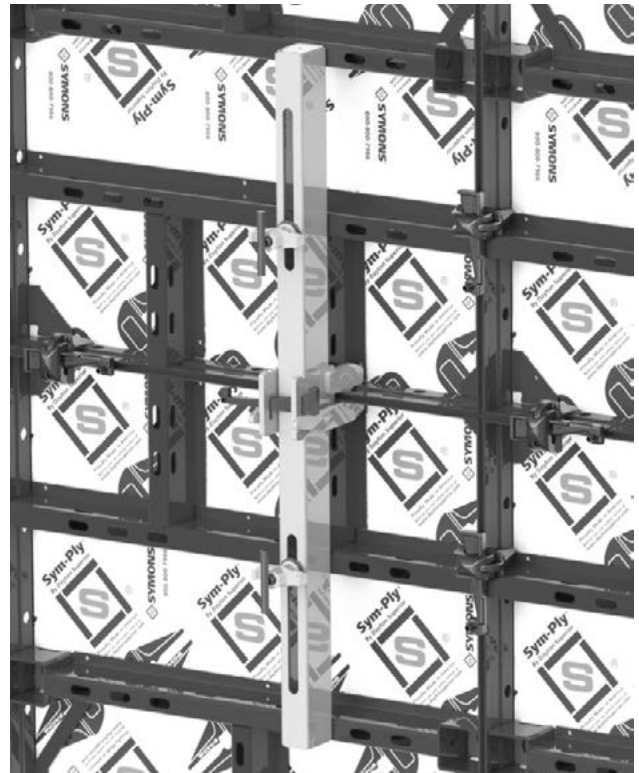

Stacking Clamp on Panels

Job-Built Fillers

NOTES:

Job-built fillers near bulkheads or outside corners require tension rods from siderail-to-siderail of panels.

When using the T-Head Sym-Bolt Assembly, always be sure that the T-Handle is perpendicular to the slot length and the T-Head is fully engaged. Then hand-tighten the wing nut plus a quarter turn.

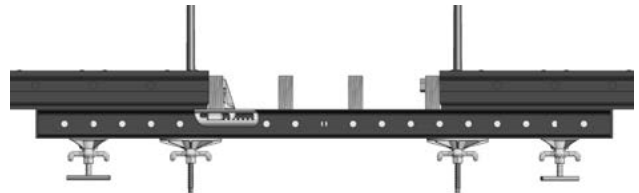

Wood Filler Option 1
($\frac{1}{2}$ " Plywood with 2x4s Backed by Short Waler Adjustable Clamp or $\frac{3}{4}$ " Bolt and Nut for Attachment)

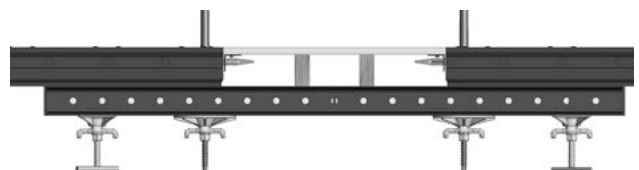

Wood Filler Option 2
($\frac{3}{4}$ " PLYWOOD WITH STEEL-PLY FILLER ANGLES BACKED BY SHORT WALER FILLER ANGLES ATTACHED WITH WEDGE BOLTS)

Slip Plate (3" to 12" Fill Range)

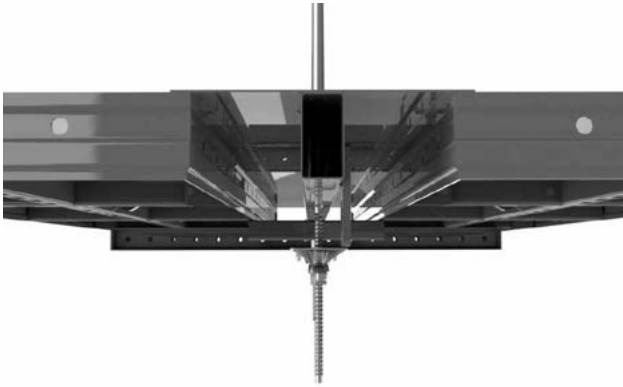

Slip Plate with Sym-Waler

NOTES:

Slip Plates leave a 1/8" deep, 14" wide indentation in the wall face.

Do not locate Slip Plate near outside corner or bulkheads as there is no tension resistance parallel to the forms.

When using the T-Head Sym-Bolt Assembly, always be sure that the T-Handle is perpendicular to the slot length and the T-Head is fully engaged. Then hand-tighten the wing nut plus a quarter turn.

①



With gangs in position, lower the Slip Plate into position.

③

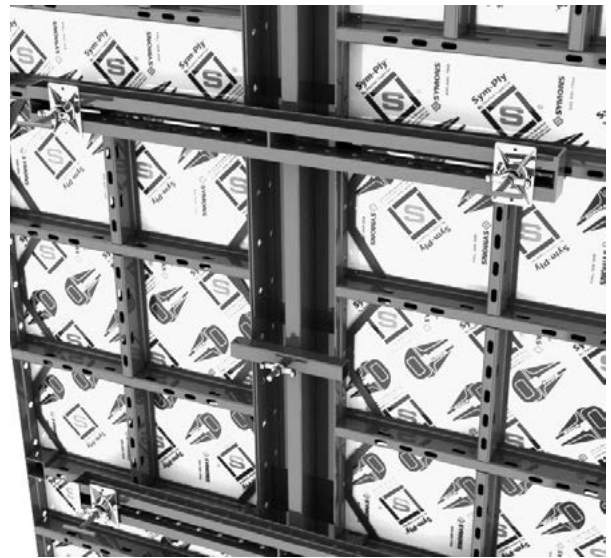

Add 60" Sym-Waler at tie locations.

②



Turn Position Bar horizontal and hand-tighten the nut.

④



Tie through the center of the Slip Plate.

Lift Bracket



To Attach



In Place



To Remove

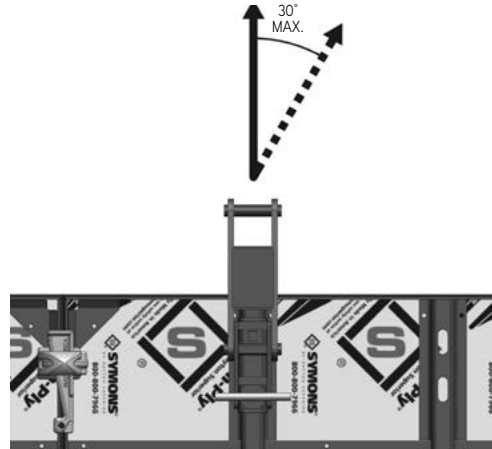

2,000 lbs. at 5 to 1 Safety Factor

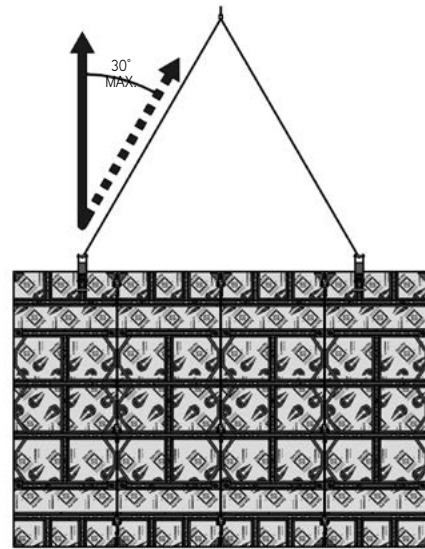

Do not fly over people.
Do not ride gang.



Do not use to strip gang.

Walkway Bracket



To Attach



To Remove

NOTE: Ends of walkway runs must also be guardrailed.



SAFETY NOTES:

500 lbs capacity at 5:1 factor of safety.

8'-0" maximum allowable spacing.

Access to the Walkway Bracket platform must be provided in accordance with applicable local, state, provincial or Federal OSHA regulations. Do not climb crossmembers to access platform!

The tie-off holes in the Sym-Ply panel crossmembers are intended for attaching fall protection hooks positioning during assembly and disassembly of formwork.

Safety goggles, hardhats, gloves and steel-toed shoes should be worn as recommended by state or Federal OSHA regulations.

Aligning Formwork

These methods are to be used for alignment only and should be placed approximately 8'-0" on for single panel high applications.



Turnbuckle to Siderail



Aligner Bracket Installation

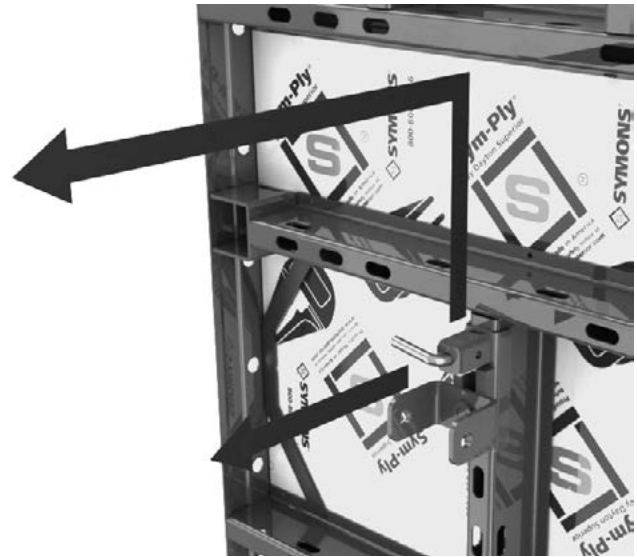

Aligner Bracket Removal



Pipe Form Aligner Adapter to Siderail



Pier Cap Brace or
Pipe Form Aligner to Vertical or Horizontal Crossmember

Columns

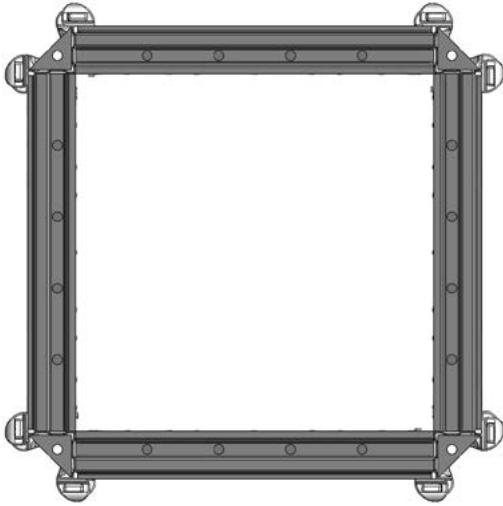

Sym-Ply Panels
1,500 psf allowable pressure

NOTE: For all Sym-Ply Panels and Outside Corners, connections may be clamped or bolted with $\frac{3}{4}$ " Speed Bolts and Nuts. See "Corner and Bulkhead Details" section for clamp spacing



Column with Lift Bracket

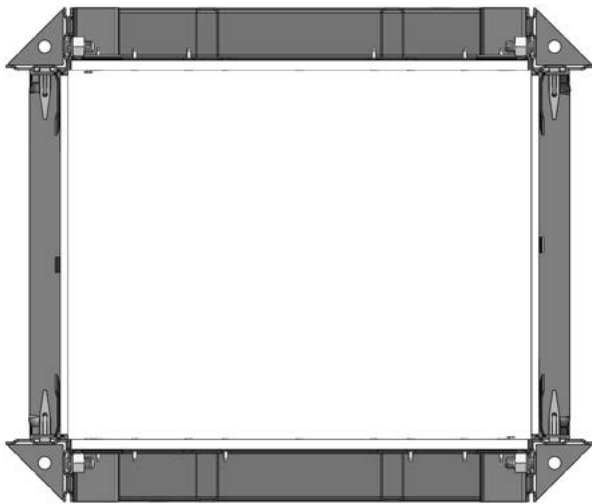

Mix of Sym-Ply Panels and Steel-Ply Fillers

NOTES:

Consult with your Regional Engineer for allowable pour pressure when using Sym-Ply and Steel-Ply.

When using Sym-Ply Outside Corners, use $\frac{3}{4}$ " Speed Bolts and Nuts if connecting to Sym-Ply, and Wedge Bolts if connecting to Steel-Ply.

When Using Steel-Ply Outside Corners, use all Wedge Bolts.

Other Tying Considerations

Foundation Formwork

Foundation formwork can be set up by using a panel laid horizontally. Use the 15mm Tie Plate in the lower position.

Top Tie Brackets can be used along the top edge of the panels instead of tying through the panels.

Battered Walls

Battered walls of up to approximately 10° (2 in 12) inclination on either side of the wall may be formed with Taper Ties or She-Bolts. A swivel tie nut is required in these cases.

Single-Sided Batters

When only one side of the wall is battered, the panel should be raised with a built-up sill. This sill should be constructed to equalize the angle between the tie and the form face.

Sym-Ply Tie-Down Bracket

The Sym-Ply Tie-Down Brackets can be anchored to the footing to provide up to 7,000 lbs of uplift resistance. The Tie-Down Bracket shall be placed so that it straddles a crossmember section.

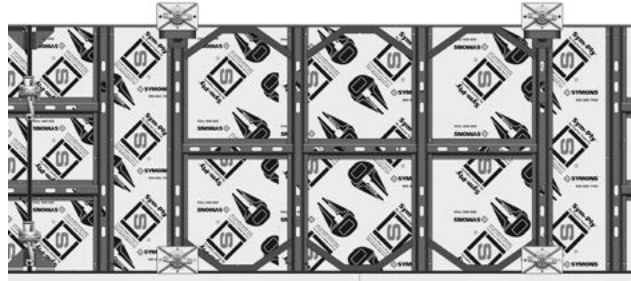

Typical Foundation Application



Typical Top Tie Application

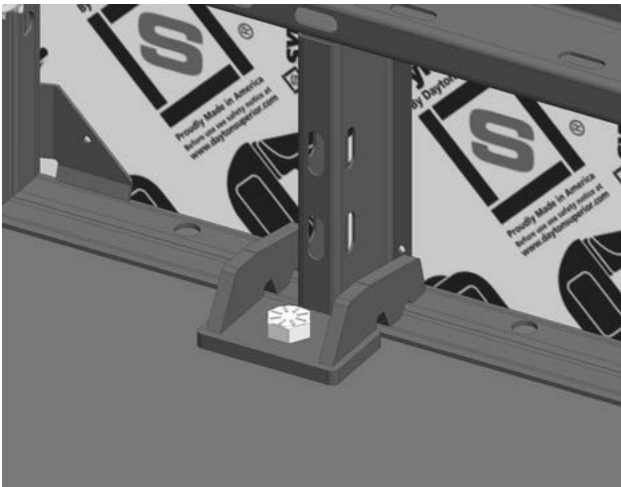

Typical Tie-Down Bracket Application



Inclination on Both Sides

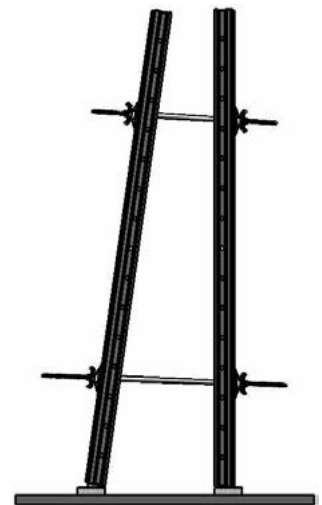

Inclination on One Side

CAUTION: Uplift forces on battered forms must be resisted with tie-downs or counterweights.

	15mm Sleeve Insert.....	5
A		
	Adjustable Sym-Clamp.....	4, 9
	Aligner Bracket.....	8
	Aligning Formwork.....	66
	Allowable Pressure.....	1
B		
	Battered Walls.....	68
	Batter Plate Casting.....	6
	Brace Kicker Bracket.....	8
	Bulkhead Details.....	55
	Bulkheads.....	61
	Bulkhead Sym-Hook.....	5
C		
	Cast Bearing Washer.....	6
	Cast Contour Nut.....	6
	Circular Tie Plate.....	6
	Clamps.....	9
	Column Details.....	56
	Columns.....	67
	Contour Nut.....	6
	Corner Details.....	55, 56
	Corners.....	59
	Corner with Fillers.....	58
D		
	DCR Bar-Type Inner Units.....	59
	Details.....	58
F		
	Fall Forward Bracket.....	7
	Filler Angles.....	2
	Fillers.....	2
	Form Alignment.....	8
	Foundation Formwork.....	68
	Frame Tie Plate.....	6
G		
	Gang Assembly.....	10
	Gangs with Stacking Clamps.....	11
	Gangs with Sym-Walers.....	32
	Guardrail Post.....	7
H		
	Hammering Cap.....	6
	Handling Bar.....	4
I		
	Inner Units.....	59
	Inside Corners.....	3
J		
	Job-Built Fillers.....	60
L		
	Lift Bracket.....	7, 64
M		
	Multi-Purpose Walers.....	61
N		
	Non-Perpendicular Corners.....	59

Index

O		
	Outside Corners.....	3
P		
	Panel Sizes.....	2
	Pier Cap Brace.....	8
	Pipe Form Aligner.....	8
	Plastic Sleeve Plate.....	5
Q		
	Quick Hook Handles.....	7
S		
	She Bolt.....	6
	She Bolt Cone.....	6
	She-Bolts.....	59
	Single-Sided Batters.....	68
	Sleeve Insert.....	5
	Sleeve Plate.....	5
	Slip Plate.....	63
	Slip Plates.....	2
	Speed Bolts.....	4
	Stacking Clamp.....	5, 62
	Stacking Panels with Stacking Clamps.....	11
	Stacking Panels with Sym-Walers.....	36
	Steel-Ply Filler Angles.....	2
	Steel-Ply Hinged Corners.....	59
	Stripping Corners.....	3
	Stripping Panels.....	3
	Sym-Bolt Assembly.....	4
	Sym-Clamp.....	4, 9
	Sym-Hook.....	5
	Sym-Ply Stacking Clamp.....	5
	Sym-Walers.....	5, 62
T		
	Taper Tie.....	6
	Taper Ties and She-Bolts.....	59
	T-Head Sym-Bolt Assembly.....	4
	Tie-Down Bracket.....	4, 68
	Tie-Off Bracket.....	5
	Tie/Plate Nut.....	6
	Tie Rod.....	6
	Tie Rod Sleeve.....	6
	Tie Systems.....	6
	Top Tie Bracket.....	6, 60
	Turnbuckle Bracket.....	3
	T-Wall.....	58
	Tying Considerations.....	68
V		
	Version 1.....	56
	Version 2.....	56
W		
	Walkway Bracket.....	7, 65
	Wedge Bolts.....	4
	Wood Fillers.....	62

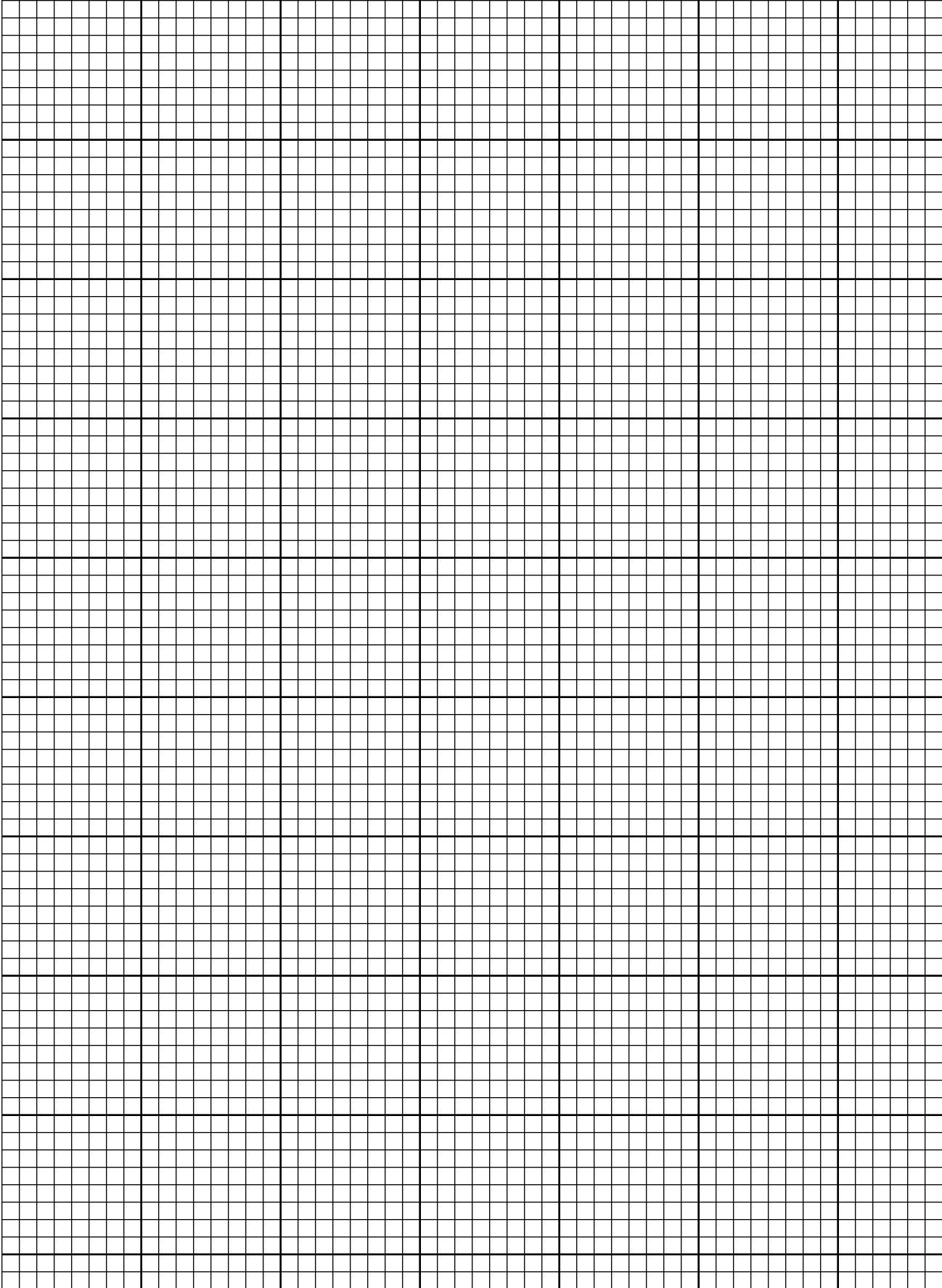

	<h2 style="text-align: center;">⚠ WARNING</h2> <h3 style="text-align: center;">Improper Use of Concrete Forms and Shores Can Cause Severe Injury or Death</h3> <p>Read, understand and follow the information and instructions in this publication before using any of the concrete construction products displayed herein. When in doubt about the proper use or installation of any Dayton Superior concrete accessory, immediately contact the nearest Dayton Superior Service Center or Technical Service Department for clarification. See back cover for your nearest location.</p>
---	--

Dayton Superior products are intended for use by trained, qualified and experienced workmen only. Misuse or lack of supervision and/or inspection can contribute to serious accidents or deaths. Any application other than those shown in this publication should be carefully tested before use.

The user of Dayton Superior products must evaluate the product application, determine the safe working load and control all field conditions to prevent applications of loads in excess of a product's safe working load. Safety factors shown in this publication are approximate minimum values. The data used to develop safe working loads for products displayed in this publication are a combination of actual testing and/or other industry sources. Recommended safe working loads given for the products in this publication must never be exceeded.

Worn Working Parts

For safety, concrete forms must be properly used and maintained. Concrete products shown in this publication may be subject to wear, overloading, corrosion, deformation, intentional alteration and other factors that may affect the device's performance. All reusable products must be inspected regularly by the user to determine if they may be used at the rated safe working load or should be removed from service. The frequency of inspections depends upon factors such as (but not limited to) the amount of use, period of service and environment. It is the responsibility of the user to schedule inspections for wear and remove the hardware from service when wear is noted.

Shop or Field Modification

Welding can compromise a product's safe working load value and cause hazardous situations. Knowledge of materials, heat treating and welding procedures is necessary for proper welding. Consult a local welding supply dealer for assistance in determining required welding procedures.

Since Dayton Superior cannot control workmanship or conditions in which modifications are done, Dayton Superior cannot be responsible for any product altered in the field.

Interchangeability

Many concrete products that Dayton Superior manufactures are designed as part of a system. Dayton Superior strongly discourages efforts to interchange products supplied by other manufacturers with components supplied by Dayton Superior. When used properly, and in accordance with published instructions, Dayton Superior products have proven to be among the best designed and safest in the industry. Used improperly or with incompatible components supplied by other manufacturers, Dayton Superior products or systems may be rendered unsafe.

Installation

WARNING

1. Dayton Superior Corporation products shall be installed and used only as indicated on the Dayton Superior Corporation installation guidelines and training materials.
2. Dayton Superior Corporation products must never be used for a purpose other than the purpose for which they were designed or in a manner that exceeds specific load ratings.
3. All instructions are to be completely followed to ensure proper and safe installation and performance
4. Any improper misuse, misapplication, installation, or other failure to follow Dayton Superior Corporation's instruction may cause product malfunction, property damage, serious bodily injury and death.

THE CUSTOMER IS RESPONSIBLE FOR THE FOLLOWING:

1. Conformance to all governing codes
2. Use of appropriate industry standard hardware
3. The integrity of structures to which the products are attached, including their capability to safely accept the loads imposed, as evaluated by a qualified engineer.

SAFETY INSTRUCTIONS:

All governing codes and regulations and those required by the job site must be observed. Always use appropriate safety equipment

Design Changes

Dayton Superior reserves the right to change product designs, rated loads and product dimensions at any time without prior notice.

Note: See Safety Notes and Safety Factor Information.



SYMONS[®]
BY DAYTON SUPERIOR

1125 Byers Road
Miamisburg, OH 45342
937-866-0711
888-977-9600

**THE
POWER
OF RED**[™]

SYM111

Rev.12/24

Copyright © 2024 Dayton Superior Corporation, All Rights Reserved.