

## **GARAGE BEAM SYSTEM (GBS)**

**CONCRETE  
FORMING  
SYSTEM**

**FIELD GUIDE**



# **THE POWER OF RED™**



**SYMONS®**  
BY DAYTON SUPERIOR



### System Presentation Drawings.....1

Isometric View "Top Jack System" 36 Kip.....	1
Typical Beam and Deck System "Top Jack System" 36 Kip .....	2
Isometric View "Ledger System" 36 Kip .....	3
Isometric View "Header/Top Jack System" 36 Kip .....	4
Typical Beam and Deck Section "Header/Top Jack System" 36 Kip.....	5
Isometric View "50 Kip Support System".....	6
Typical Beam and Deck Section "50 Kip Support System" .....	7
Deck Panel: Exploded View .....	8
Deck Panel: Assembled View .....	8
Standard Steel Capital: Exploded View.....	9
Standard Steel Capital: Assembled View .....	9
Ramp Capital (Exploded View).....	10
Ramp Capital (Assembled View) .....	11

### General Set Of Field Drawings.....12

Sample GBS Project Cover Sheet.....	12
Sample GBS Safety Sheet.....	13
Sample GBS Information and Reference Sheet.....	14
Sample Beam Form and Falsework Layout Drawing.....	15
Sample Capital and Ramp Capital Layout Drawing.....	16
Sample Deck Panel and Hand-Set Layout Drawing.....	17
Sample Interior Beam Form Elevation Drawing .....	18
Sample Transfer Girder Elevation Drawing .....	19
Sample Perimeter Beam Form Elevation Drawing.....	20
Sample Falsework Elevation Drawing .....	21
Sample Capital Assembly Drawing .....	22
Sample Interior Deck Panel Assembly Drawing .....	23
Sample Perimeter Deck Panel Assembly Drawing.....	24
Sample Ramp Separation Deck Panel Assembly Drawing.....	25
Sample Ramp Capital Drawing (Interlocked).....	26
Sample Ramp Capital Drawing (Separated) .....	27

### Tools, Equipment & Assembly Details ..... 28

Beam Form Assembly Tool List.....	28
Deck Panel Assembly Tool List.....	29
Load Capacity Chart .....	30
Gas Forklift .....	30
Electric Forklift .....	31
Beam Form Handling .....	32
Staging and Build Up Area: Slab On Grade Build-Up Area .....	33
Staging and Build Up Area: Waste Slab Build-Up Area .....	33
Top Jack System Suggested Yard Layout.....	34
GBS Top Jack System Beam Assembly Procedures.....	35
Ledger System Suggested Yard Layout.....	36
GBS Ledger System Beam Assembly Procedures .....	37
Header/Top Jack System Suggested Yard Layout.....	38
GBS Header and Top Jack System Beam Assembly Procedures.....	39
50 Kip System Suggested Yard Layout.....	40
GBS 50 Kip System Beam Assembly Procedures .....	41
Deck Panel Staging and Assembly Suggested Yard Layout .....	42
GBS Deck Panel Assembly Procedures.....	43
Capital and Ramp Capital Assembly Suggested Yard Layout.....	44
GBS Capital Assembly Procedures.....	45
GBS Ramp Capital Assembly Procedures.....	45
Bolt Detail.....	46
Beam Bolt-Up Procedure .....	46

Stringing the Beam Form .....	47
Fixing A Dog Leg.....	48
Wood Nailer Assembly Procedure.....	49
Wood Nailer Attachment Procedure.....	50
Beam Form Build-Up Details .....	51
End Beam Bolt-Up Procedure .....	52
Stringer Support Arm Attachment.....	53
Stripping Saddle Quantity Requirements.....	54
Stripping Saddle Attachment .....	54
Ledger Support Bracket Attachment .....	55
Hinged Scaffold Bracket Attachment.....	56
Edge Deck Scaffold Bracket Attachment.....	57
Bottom Jack and Jack Retainer Assembly.....	58
Beam Form to Garage Frame with Spacers Bolt-Up Details.....	59
Intermediate Rib Frame Adapter Bolt-Up Detail .....	60
Beam Form to Header Bolt-Up Detail.....	61
Beam Form to Header with Spacers Bolt-Up Detail .....	62
Header Hinge Plate Attachment to the Header and to the Shoring Frame.....	63
6", 12", 18" and 24" Frame Leg Extensions .....	64
Adjustable Slider Leg Extensions Installation and Range .....	65
Slider Leg Extension and Slider Jack Retainer Assembly.....	66
W8" x 15# Stringer to Top Jack Attachment.....	67
W8" x 10# Stringer to Ledger Bracket Attachment.....	68
Beam Form to 50 Kip Header Bolt-Up Detail .....	69
Beam Form to 50 Kip Header Bolt-Up Detail Using 50 Kip Frame Spacer .....	70
W8" x 15# Stringer to 25 Kip Top Jack Attachment .....	71
25 Kip Bottom Jack and Jack Retainer Assembly.....	72
Top Jack Grading Template and Use .....	73
Lowering Beam Form onto Beam Dollies .....	74
Beam Assembly Elevation.....	75
Handling Beam Form with Header/Top Jack System .....	75

### Typical Field Detail Drawings ..... 76

Beam and Deck Section at High Bay Condition .....	76
Beam Form Stripping Procedures .....	77
Transfer Girder Stripping Procedures .....	78
Standard Cantilever Frame Condition Using Hinged Scaffold Brackets.....	79
Standard Cantilever Frame Condition Using Edge Deck Scaffold Brackets .....	80
Falsework Assembly Usage at Wall .....	81
Section at Quarter Point Pour Break: First Side Pour.....	82
Section at Quarter Point Pour Break: Second Side Pour .....	83
Section at Delayed Pour Strip: First Side Pour .....	84
Section at Delayed Pour Strip: Second Side Pour.....	85
Section at Delayed Pour Strip: Full Floor of Equipment .....	86
Quarter Point Deck Panel Placement .....	87
Beam Dolly Engagement at Perimeter Beam.....	88
Vertical Beam Stripping Detail at Perimeter .....	89
Steel Capital at Shear Wall.....	90
Wood Capital Assembly Details (As Designed and Supplied by Contractor) .....	91
Plywood Beam Extension Connection Detail.....	92
Double 2x8 Stringer Extension Detail and Stringer Filler Detail....	93
Typical Top Jack Frame/Stringer Offset Procedure.....	94
Typical Top Jack System Post Shore Details .....	95

SYSTEM  
PRESENTATION  
DRAWINGS

GENERAL SET OF  
FIELD DRAWINGS

ASSEMBLY DETAILS

TYPICAL FIELD  
DETAIL DRAWINGS

SETTING AND  
STRIPPING  
PROCEDURES

EXAMPLE OF LABOR  
MANAGEMENT

PICTURE  
PRESENTATION OF  
THE SYSTEM

### Typical Field Detail Drawings (continued) ..... 96

Typical Ledger System Post Shore Details .....	96
Transporting the Beam Through the Ramp Cross-Over .....	97
Deck Panel Reference and Schematic Details.....	98
Typical Deck Panel Deck Bolt and Quarter Point Deck Bolt Details .....	99
Typical Deck Panel Plywood Over-Hang and Edge Details.....	100
Typical Deck Panel Hand-Set Detail.....	101

### Setting and Stripping Procedures .....103

Crew Designations.....	103
Capital Marketing Procedures.....	104
Transporting the Capital Assemblies.....	105
Capital Assembly Setting Procedures.....	106
Capital Assembly Setting Procedures continued .....	107
Capital Stripping Procedures.....	108
Transporting the Beam Form Assemblies .....	109
Beam Form Setting Procedures 1.....	110
Beam Form Setting Procedures 2 .....	111
Beam Form Setting Procedures 3 .....	112
Beam Form Setting Procedures 4 .....	113
Beam Form Setting Procedures 5 .....	114
Beam Form Setting Procedures 6 .....	115
Beam Form Setting Procedures 7.....	116
Transfer Girder Setting Procedures 1 .....	117
Transfer Girder Setting Procedures 2 .....	118
Beam Assembly Stripping Procedures.....	119
Beam Assembly Stripping Procedures continued .....	120
Beam Form Stripping Stages.....	121
Transporting the Deck Panels.....	122
Deck Panel Setting Procedures 1 .....	123
Deck Panel Setting Procedures 2 .....	124
Deck Panel Setting Procedures 3.....	125
Deck Panel Setting Procedures 4 .....	126
Deck Panel Setting Procedures 5.....	127
Deck Panel Setting Procedures 6; Hand-Set Decking Setting Procedures.....	128
Deck Panel Stripping Procedures .....	129
Deck Panel Stripping Procedures continued .....	130

### Example Of Labor Management .....132

Labor Management.....	132
Labor Management continued .....	133-136
Two Form-Set Production Schedule; Standard Pour Schedule .....	137
Two Form-Set Production Schedule; Accelerated Pour Schedule .....	138
Three Form-Set Production Schedule; Accelerated Pour Schedule .....	139
Four Form-Set Production Schedule; Accelerated Pour Schedule .....	140

### Packing And Shipping Details .....142

Packing and Shipping Procedure for Beam Forms .....	142
Packing and Shipping Procedure for Frame Equipment and Jack Equipment.....	143
Packing and Shipping Procedure for Frame Equipment and Jack Equipment continued.....	144

SYSTEM  
PRESENTATION  
DRAWINGS

GENERAL SET OF  
FIELD DRAWINGS

ASSEMBLY DETAILS

TYPICAL FIELD  
DETAIL DRAWINGS

SETTING AND  
STRIPPING  
PROCEDURES

EXAMPLE OF LABOR  
MANAGEMENT

PICTURE  
PRESENTATION OF  
THE SYSTEM

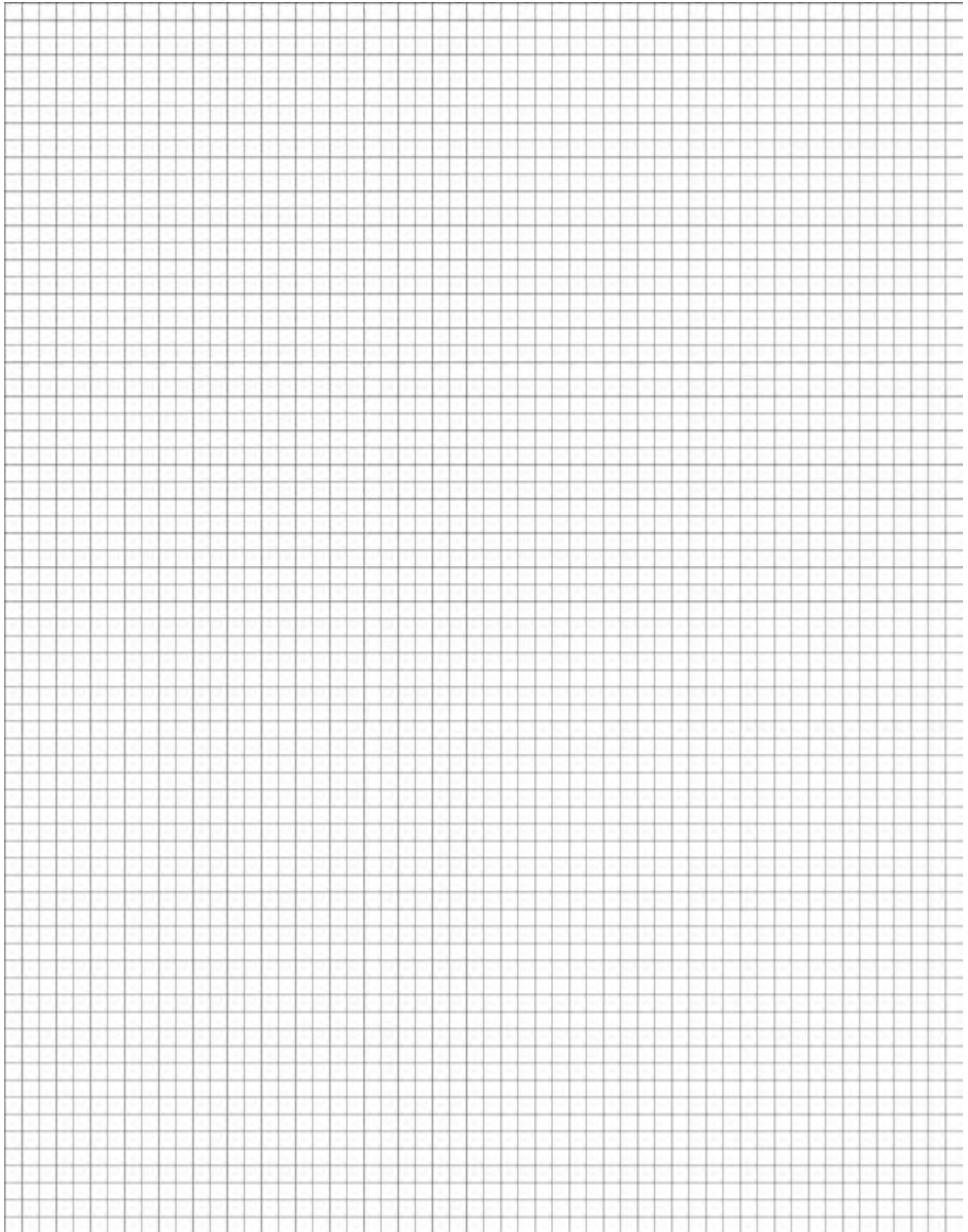

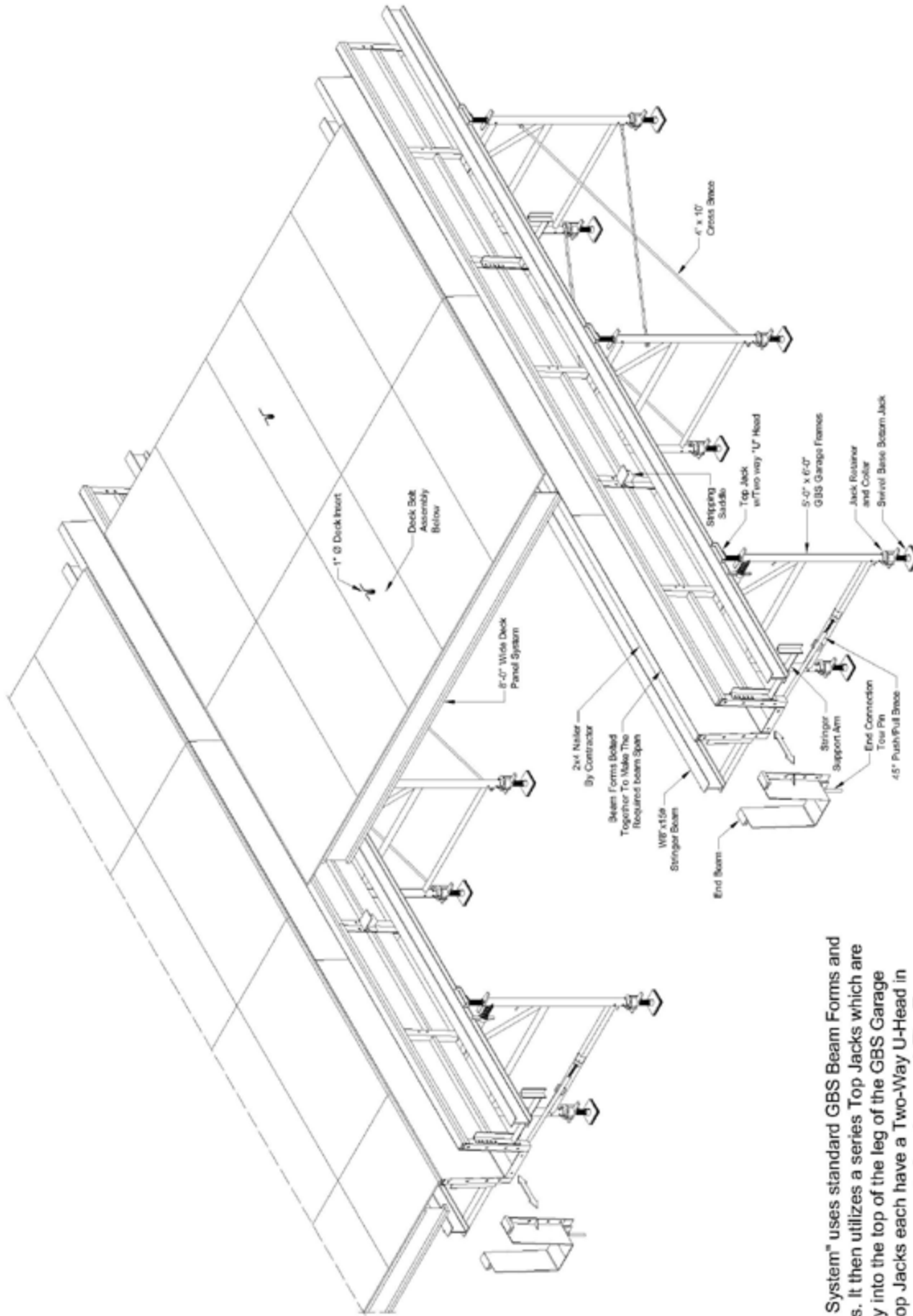

## Isometric View "Top Jack System" (36 Kip System)

The "Top Jack System" uses standard GBS Beam Forms and Garage Frames. It then utilizes a series of Top Jacks which are inserted directly into the top of the leg of the GBS Garage Frames. The Top Jacks each have a Two-Way U-Head in which the Stringers are supported and secured. The Top Jacks and Stringers can quickly be adjusted up and down which allows them to be set to any desired grade.

This System can easily be reconfigured to allow for the Formwork to move from Flat Slab Conditions, to Ramp Slab Conditions, and back to Flat Slab Conditions.

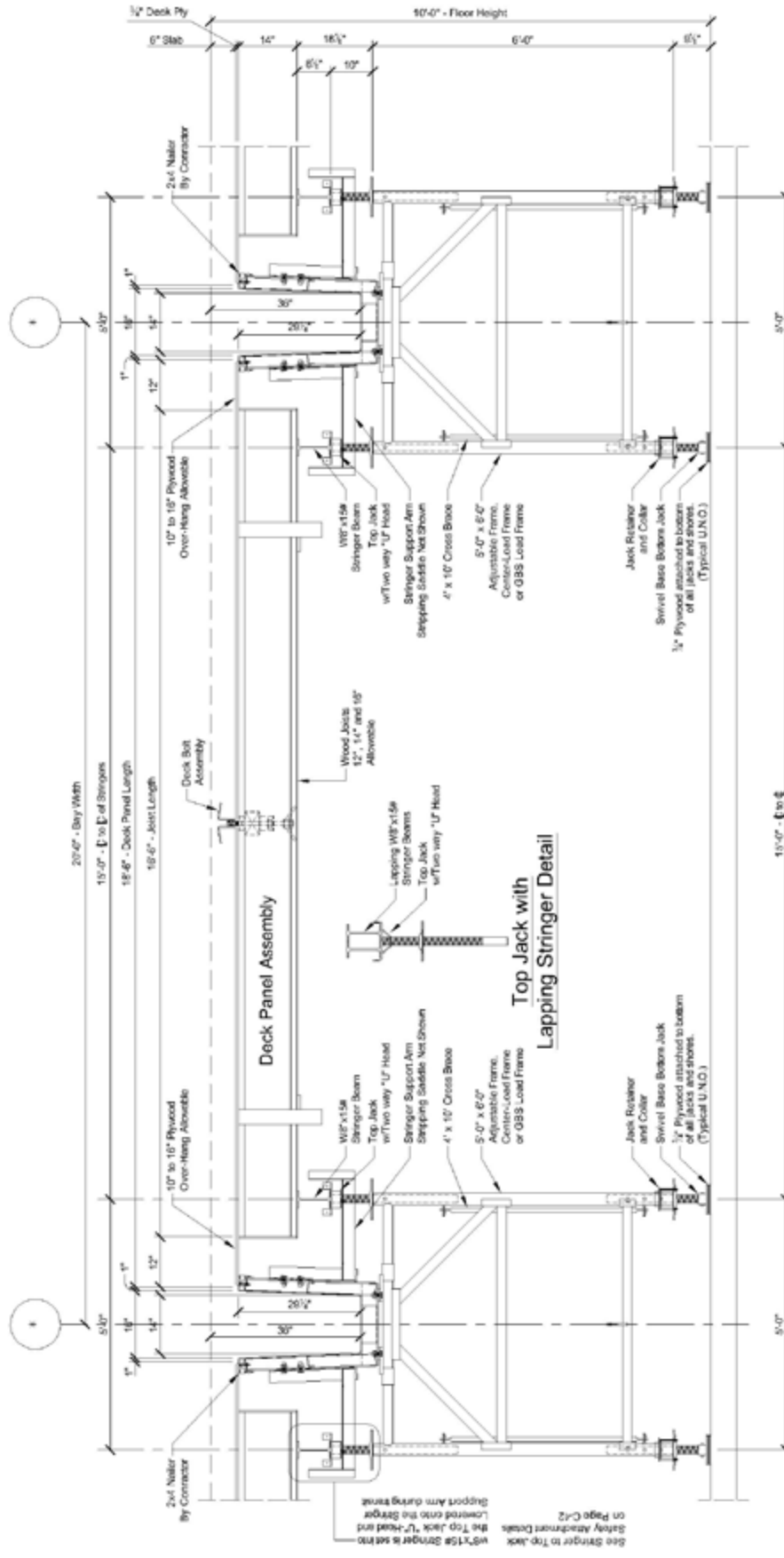

## Typical Beam and Deck Section "Top Jack System" (36 Kip System)

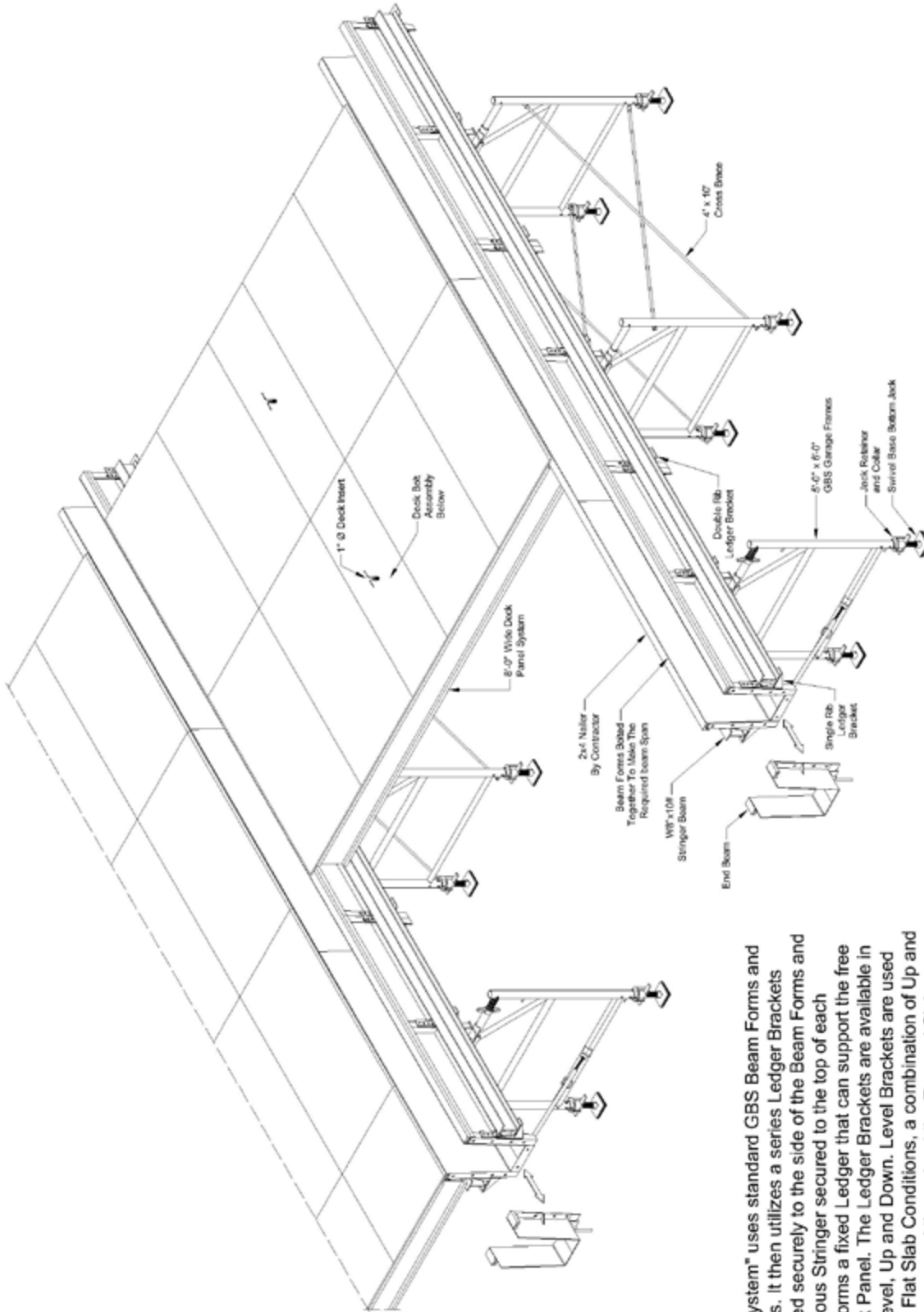

## Isometric View" "Ledger System" (36 Kip System)

The "Ledger System" uses standard GBS Beam Forms and Garage Frames. It then utilizes a series of Ledger Brackets which are bolted securely to the side of the Beam Forms and have a continuous Stringer secured to the top of each Bracket. This forms a fixed Ledger that can support the free spanning Deck Panel. The Ledger Brackets are available in three styles: Level, Up and Down. Level Brackets are used throughout the Flat Slab Conditions, a combination of Up and Down Brackets are used throughout the Ramped Slab Conditions and a combination of Level/Up and Level/Down can be used at the Start and End of Ramp Conditions.

The system is used on "High Production" Garages where all the Beams are either on the flat or in the same position in each area of concrete placement.



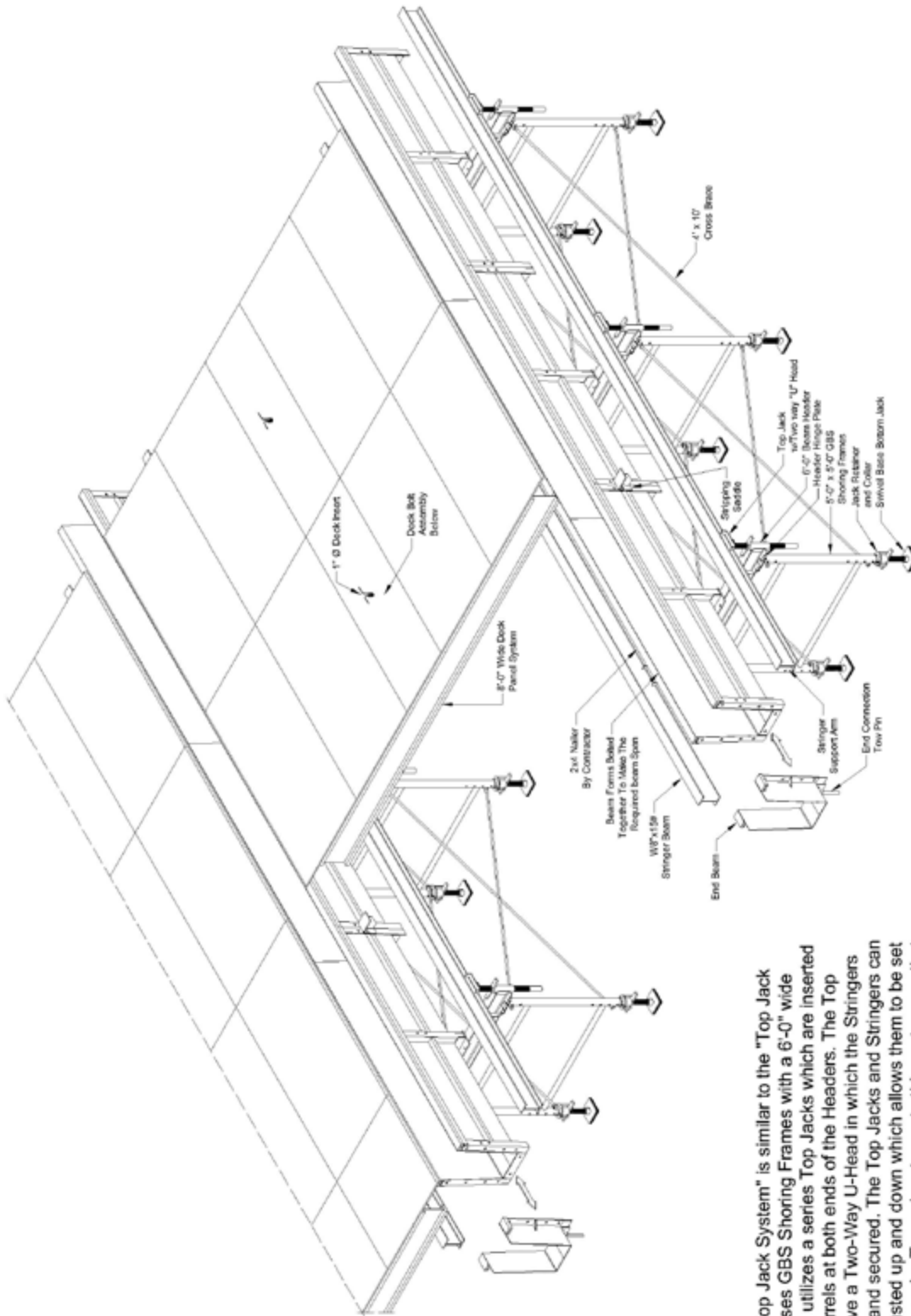

## Isometric View "Header/Top Jack System" (36 Kip System)

Like the Top Jack System, The Header/Top Jack System can easily be reconfigured between flat and ramp conditions.

The "Header Top Jack System" is similar to the "Top Jack System", but uses GBS Shoring Frames with a 6'-0" wide Header. It then utilizes a series Top Jacks which are inserted directly into barrels at both ends of the Headers. The Top Jacks each have a Two-Way U-Head in which the Stringers are supported and secured. The Top Jacks and Stringers can quickly be adjusted up and down which allows them to be set to any desired grade. Two advantages to this system are that 1). Due to the 6'-0" Header, the Bay Span between the two Top Jacks is reduced by 1'-0", which allows for greater span capabilities and 2). The Frames hinge up from below the Header, this allows for the Top Jacks to remain rigid in position during transport, which eliminates the need to re-adjust the Stringers to grade in most applications.

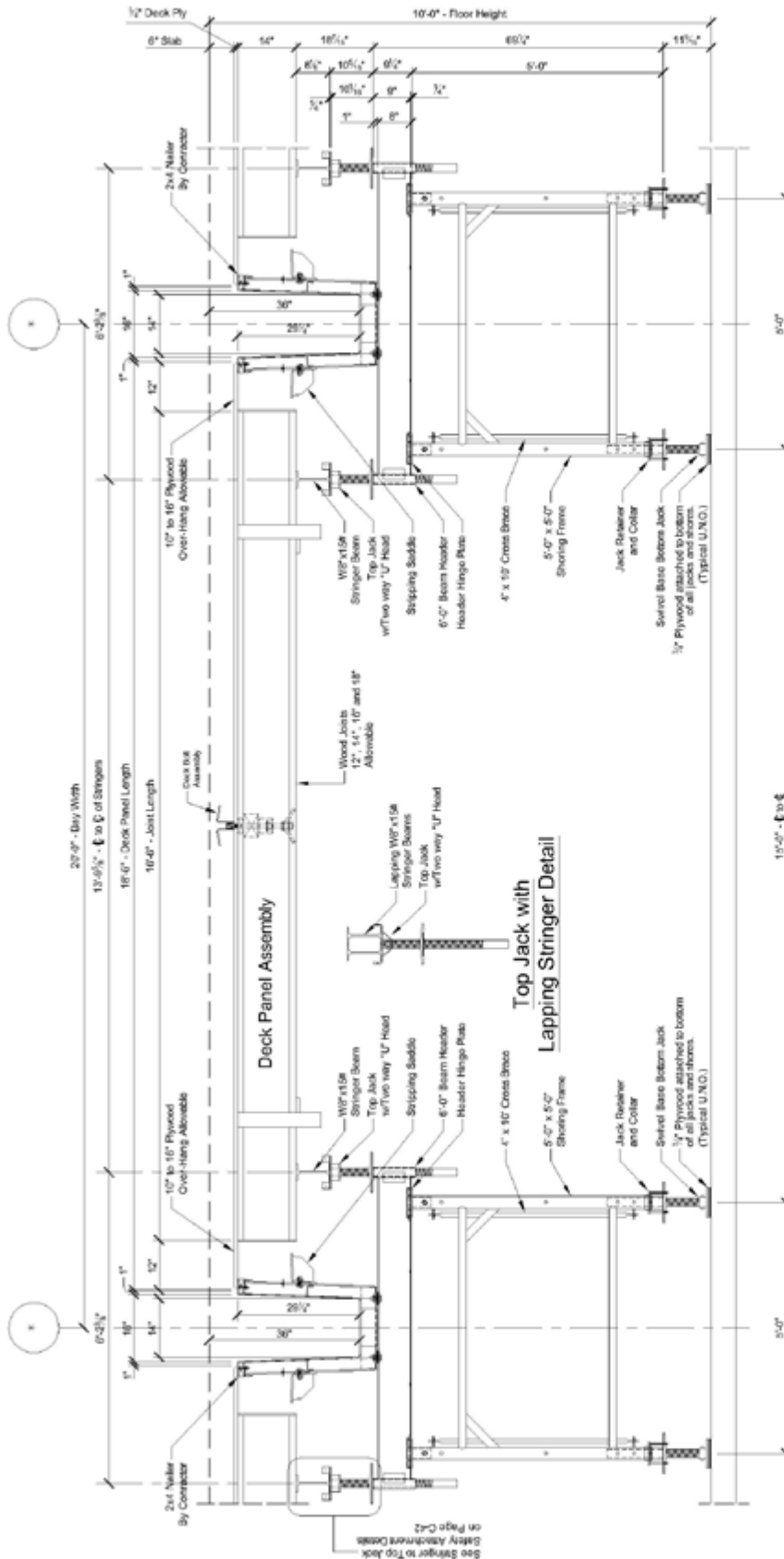

**Typical Beam and Deck Section**  
**"Header / Top Jack System"**  
**(36 Kip System)**

SYSTEM  
PRESENTATION  
DRAWINGS

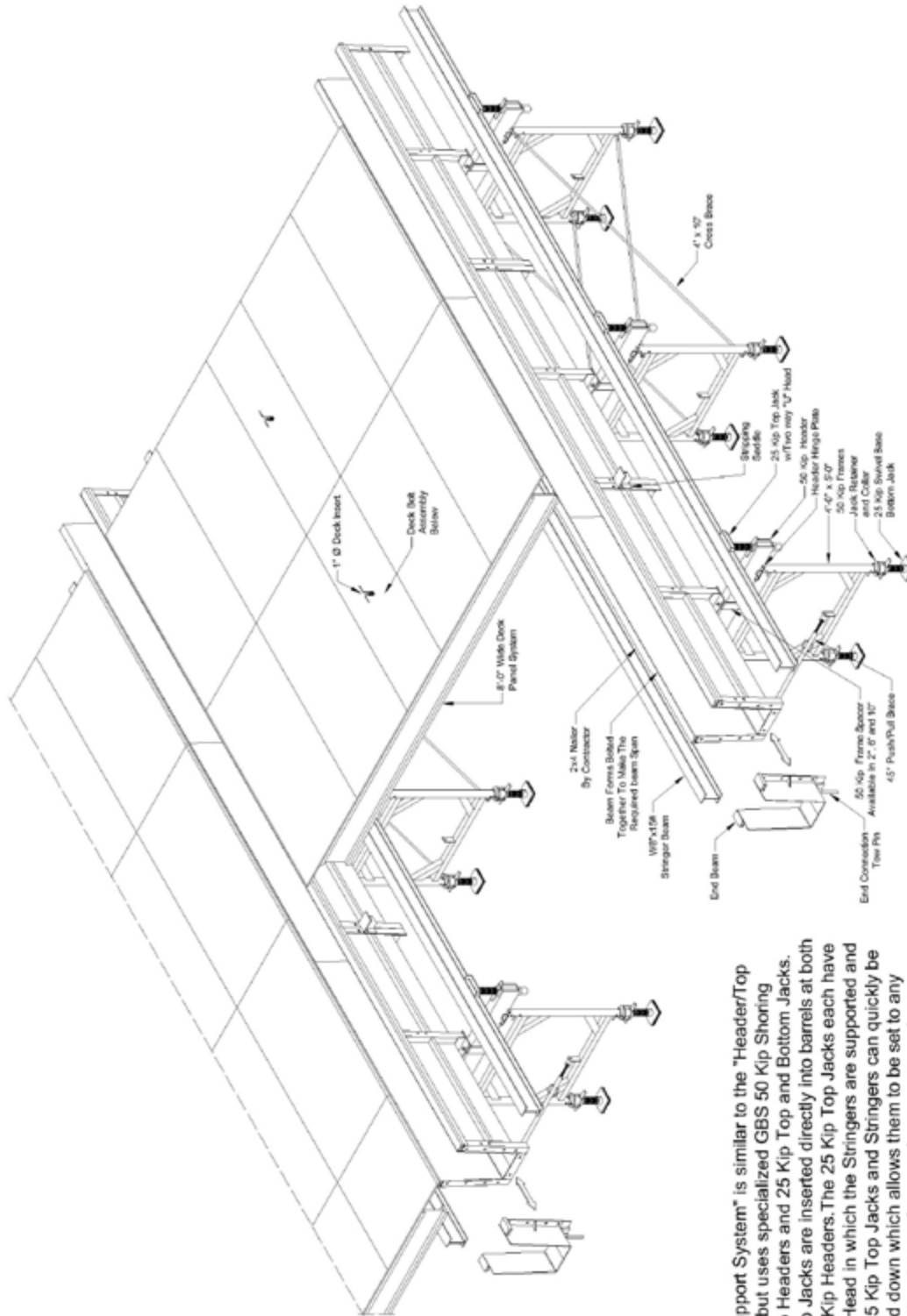

## Isometric View "50 Kip Support System" (50 Kip System)

The "50 Kip Support System" is similar to the "Header/Top Jack System", but uses specialized GBS 50 Kip Shoring Frames, 50 Kip Headers and 25 Kip Top and Bottom Jacks. The 25 Kip Top Jacks are inserted directly into barrels at both ends of the 50 Kip Headers. The 25 Kip Top Jacks each have a T-wo-Way U-Head in which the Stringers are supported and secured. The 25 Kip Top Jacks and Stringers can quickly be adjusted up and down which allows them to be set to any desired grade. The 50 Kip Support System allows for the heaviest loads and the widest spans of all of the GBS Systems. Like the Header/Top Jack System, the Frames of the 50 Kip Support System hinge up from below the Header, this allows for the Top Jacks to remain rigid in position during transport, which eliminates the need to re-adjust the Stringers to grade in most applications.

Like the Header/Top Jack System, The 50 Kip Support System can easily be reconfigured between flat and ramp conditions.



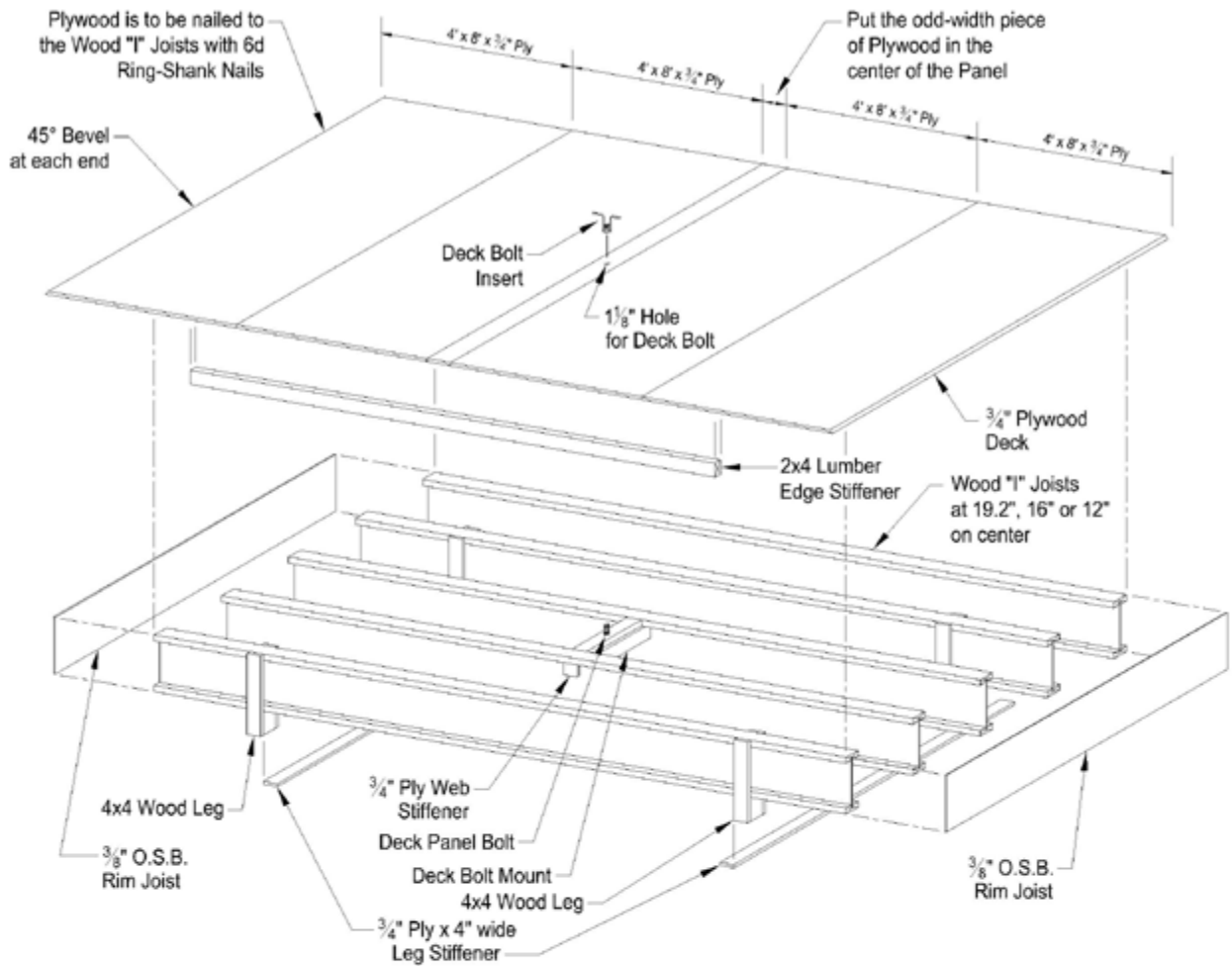

### Exploded View

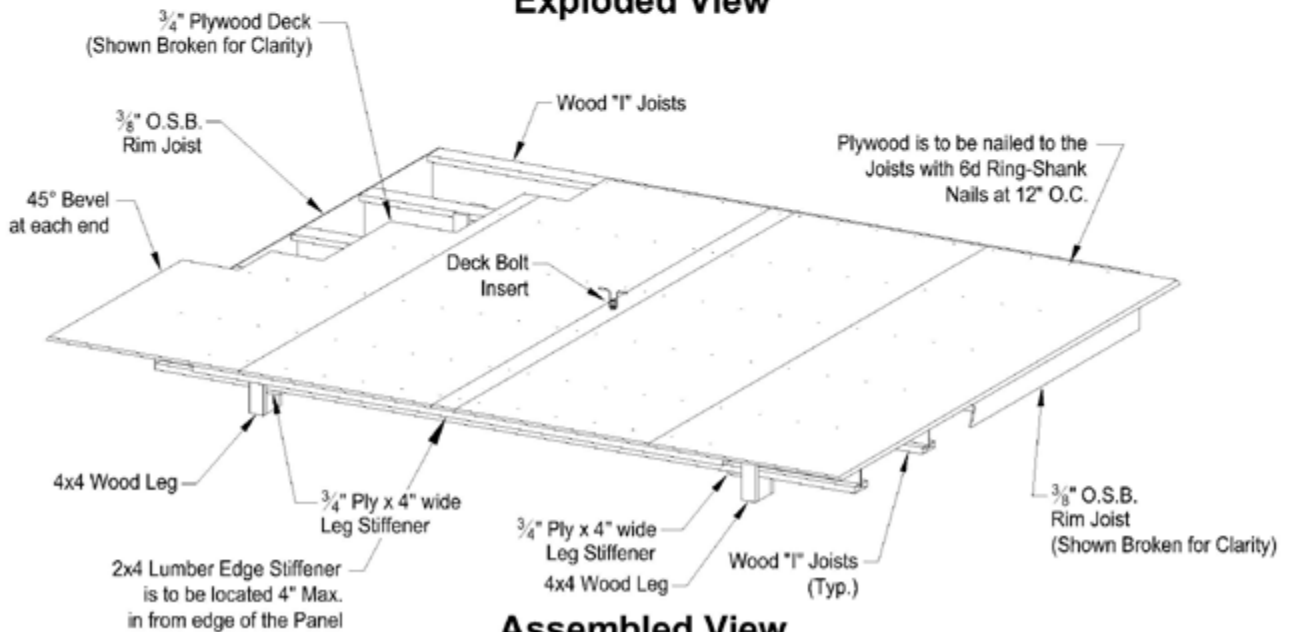

### Assembled View

### Deck Panel

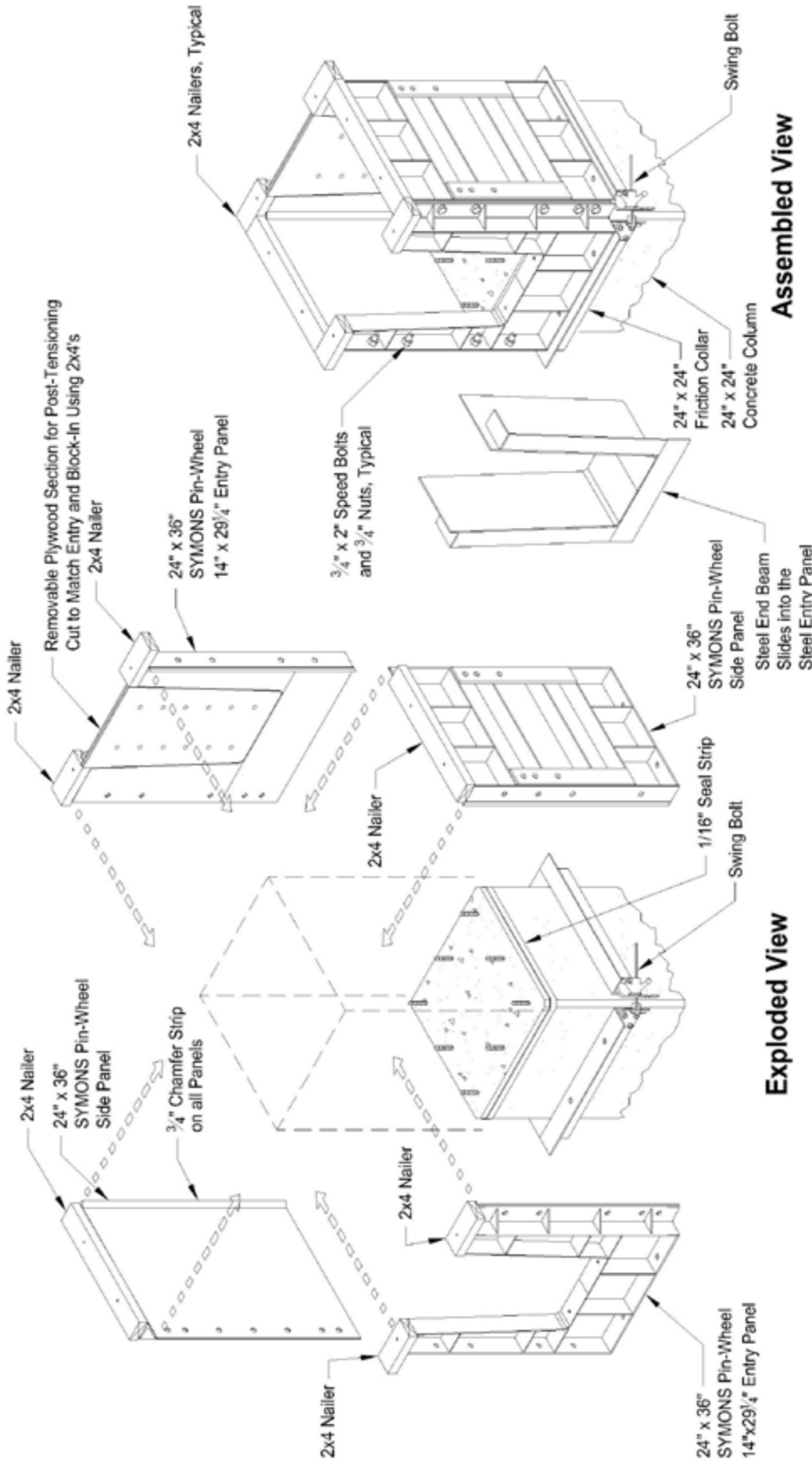

Note that Pin-Wheel Type Capital Panels are shown on this Drawing.  
Pin-Wheel Type Capital Panels consist of one square side with a welded 3/4" Chamfer and one lapping side with a fixed 3"x3" Angle.

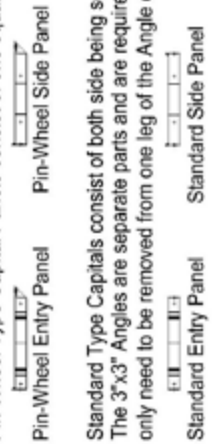

Standard Type Capitals consist of both side being square. Side Panels have 3/4" Chamfers Entry Panel do not have Chamfers. The 3"x3" Angles are separate parts and are required in each corner (once the Angles are attached, to the Panels, the Bolts only need to be removed from one leg of the Angle during the Stripping Procedure).

## Standard Steel Capital

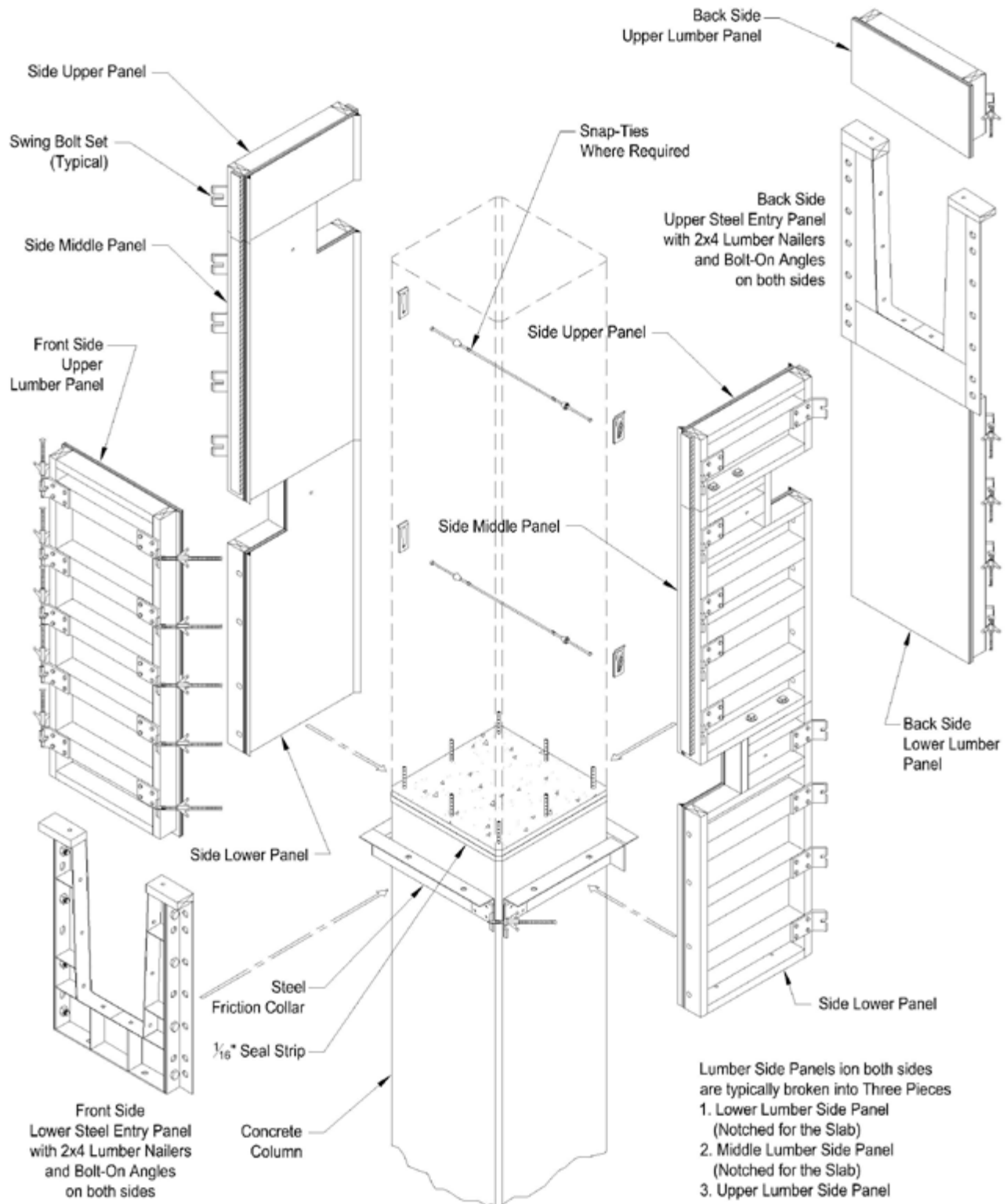

NOTE: Attach Swing Bolts to the Entry Panels and attach the Receivers to the Side Panels

NOTE: Lumber Panels are made up from 3/4" Plywood Skin, 2x4 Bottom, Top and Side Ribs, 4x4 Walers, 2x4 Framing around the Entry and 3/4" Chamfer Strip, where required.

NOTE: See Page A-12 for Assembled View and Additional Information

## Ramp Capital (Exploded View)

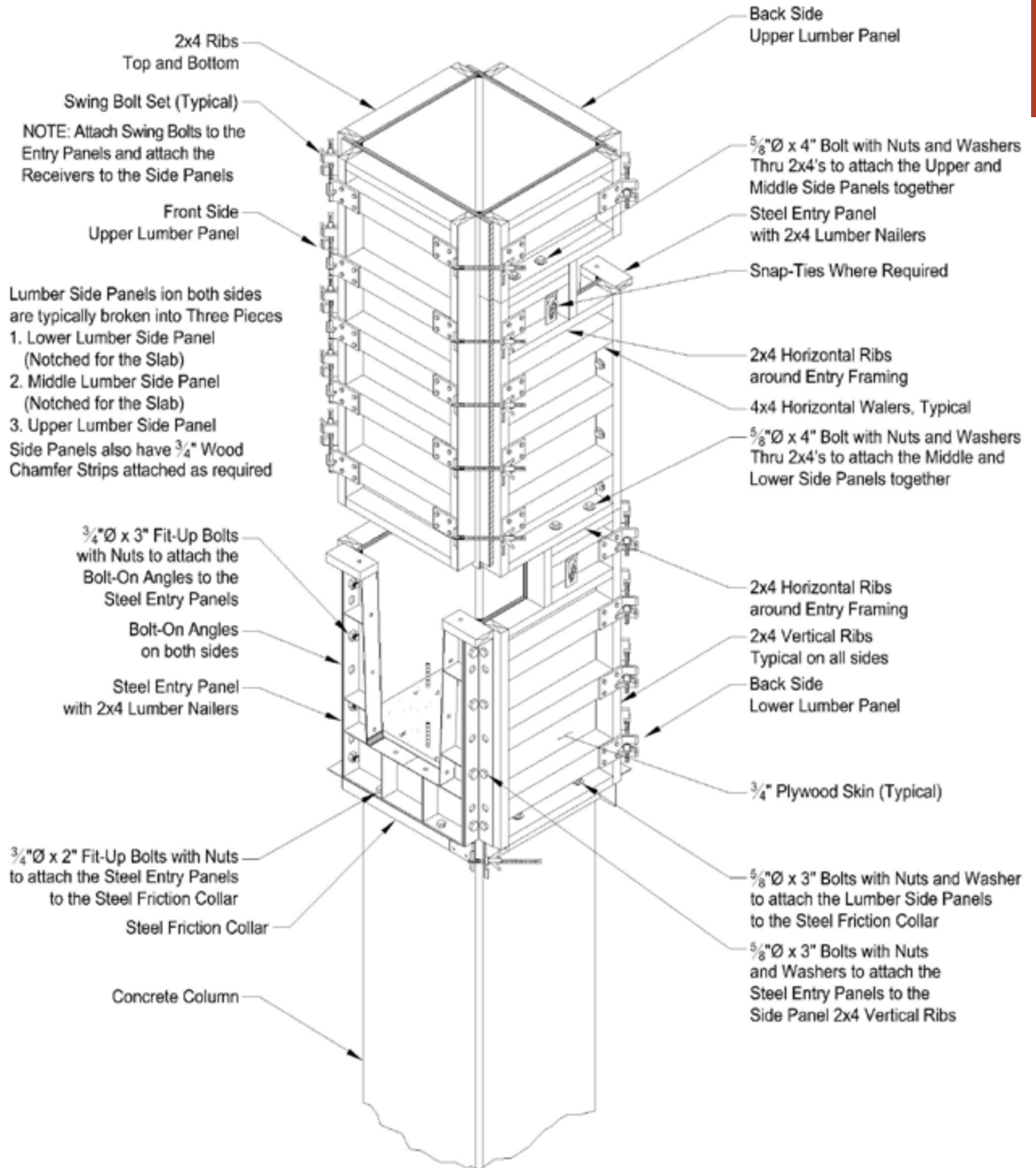

NOTE: See Page A-11 for Exploded View and Additional Information

### Ramp Capital (Assembled View)





# GBS Shoring Safety Rules



## GBS GENERAL NOTES:

THESE DRAWINGS ARE PROVIDED AS A SERVICE TO ILLUSTRATE THE ASSEMBLY OF SYMONS PRODUCTS ONLY. THEY ARE NOT INTENDED TO BE FULLY DETAILED, NOR COVER ENGINEERING DETAILS OF SUCH PRODUCTS, OR EQUIPMENT OR MATERIALS, NOR COVER BY SYMONS NOR THE INTERCONNECTION THEREWITH. IN AS MUCH AS SYMONS DOES NOT WARRANT THE FITNESS OF ANY EQUIPMENT OR MATERIALS FOR ANY PARTICULAR USE OR EQUIPMENT PROVIDED BY OTHERS, IT IS THE RESPONSIBILITY OF THE CONTRACTOR TO INTEGRATE THESE DRAWINGS INTO A COMPOSITE DRAWING SUFFICIENTLY COMPLETE FOR CONSTRUCTION PURPOSES CONSISTENT WITH SAFE PRACTICE AND OVERALL PROJECT OBJECTIVES. SYMONS SHALL NOT BE RESPONSIBLE IN THE EVENT OF ANY DEVIATIONS OR OMISSIONS FROM THESE DRAWINGS UNLESS SUCH DEVIATIONS, CHANGES OR ALTERATIONS ARE ILLUSTRATED IN A REVISED SYMONS DRAWING OR ARE APPROVED IN WRITING BY AN AUTHORIZED SYMONS REPRESENTATIVE.

1. ALL DIMENSIONS AND DETAILS SHOWN ON THESE LAYOUTS MUST BE CHECKED AND VERIFIED BY THE CONTRACTOR BEFORE PROCEEDING WITH THE WORK.
2. THE CONCRETE SUPPORTED BY THE SHORING SHOWN ON THESE LAYOUTS ARE ASSUMED TO BE 150 LBS PER CU YD OF CONCRETE.
3. THE DESIGN LAYOUT INCLUDES A LIVE LOAD OF 50 LBS PER SQUARE FOOT PER ACI 308 (EXCLUDING FORMS) WHICH DOES NOT INCLUDE PROVISIONS FOR MOTORIZED CONCRETE EQUIPMENT.

## SINGLE POST SHORE SAFETY RULES

As Recommended by the SCAFFOLDING, SHORING AND FORMING INSTITUTE, INC. (Safe Scaffolding, Shoring, Erection Procedure, Safety Rules, Recommended Steel Frame Shoring Construction Procedure, Recommended Safety Requirements for Shoring Concrete Formwork.) Following are some common sense rules designed to promote safety in the use of Single Post Shores. These rules are illustrative and not exclusive or to supplement or replace other additional safety and universal conditions. They are not intended to conflict with, or supersede any state, local, or federal statutes or regulations, references to such specific provisions should be made by the user. (See Rule 1.)

- I. POST THESE SINGLE POST SHORES SAFELY IN A COMPANION PLACE and be sure that all persons, who erect, dismantle or use Single Post Shores are well-informed of the regulations pertaining to shoring.
- II. RESPECT ALL EQUIPMENT BEING USED. Never use any equipment that is damaged.
- III. INSPECT ALL SHORING BEFORE USING. Immediately prior to pour - a. DO NOT EXCEED THE SHORING AND FORMING CAPACITY OF THE SHORING. b. CHECK YOUR SHORING EQUIPMENT SUPPLIER WHEN IN DOUBT.
- IV. A SHORING LAYOUT — Should be available and used on the job site at all times.

As Recommended by the SCAFFOLDING, SHORING AND FORMING INSTITUTE, INC. (Safe Scaffolding, Shoring, Erection Procedure, Safety Rules, Recommended Steel Frame Shoring Construction Procedure.) Following are some common sense rules designed to promote safety in the use of steel frame shoring equipment. These rules are illustrative and not exclusive or to supplement or replace other additional safety and universal conditions. They are not intended to conflict with, or supersede any state, local, or federal statutes or regulations, references to such specific provisions should be made by the user. (See Rule 1.)

- I. POST THESE SINGLE POST SHORES SAFELY IN A COMPANION PLACE and be sure that all persons, who erect, dismantle or use Single Post Shores, are well-informed of the regulations pertaining to shoring.
- II. RESPECT ALL EQUIPMENT BEING USED. Never use any equipment that is damaged.
- III. INSPECT ALL SHORING BEFORE USING. Immediately prior to pour - a. DO NOT EXCEED THE SHORING AND FORMING CAPACITY OF THE SHORING. b. CHECK YOUR SHORING EQUIPMENT SUPPLIER WHEN IN DOUBT.
- IV. A SHORING LAYOUT — Should be available and used on the job site at all times.

## STEEL SHORING SAFETY RULES

As Recommended by the SCAFFOLDING, SHORING AND FORMING INSTITUTE, INC. (Safe Scaffolding, Shoring, Erection Procedure, Safety Rules, Recommended Steel Frame Shoring Construction Procedure.) Following are some common sense rules designed to promote safety in the use of steel frame shoring equipment. These rules are illustrative and not exclusive or to supplement or replace other additional safety and universal conditions. They are not intended to conflict with, or supersede any state, local, or federal statutes or regulations, references to such specific provisions should be made by the user. (See Rule 1.)

- I. POST THESE SINGLE POST SHORES SAFELY IN A COMPANION PLACE and be sure that all persons, who erect, dismantle or use Single Post Shores, are well-informed of the regulations pertaining to shoring.
- II. RESPECT ALL EQUIPMENT BEING USED. Never use any equipment that is damaged.
- III. INSPECT ALL SHORING BEFORE USING. Immediately prior to pour - a. DO NOT EXCEED THE SHORING AND FORMING CAPACITY OF THE SHORING. b. CHECK YOUR SHORING EQUIPMENT SUPPLIER WHEN IN DOUBT.
- IV. A SHORING LAYOUT — Should be available and used on the job site at all times.

4. GBS FRAME SAFETY JACK EXTENSIONS FOR THESE LAYOUTS ARE LIMITED TO 10" TOP AND 10" BOTTOM MAXIMUM.
5. SUBMITTALS MUST BE PROVIDED TO PROPERLY DETERMINE LOADS IMPOSED BY SHORING LOADS ON THE GROUND OR SUPPORTING FOUNDATION TO ASSURE ADEQUATE STABILITY FOR ALL SHORING LOADS.
6. ALL STRUTTERS, LEDGERS, OR OTHER MEMBERS RESTING ON SYMONS EQUIPMENT, MUST BE CENTERED DIRECTLY OVER SHORING LEVEL, UNLESS OTHERWISE SPECIFIED.
7. IN SETTING ELEVATIONS, ALLOW FOR LAMBER COMPRESSION.
8. THE TIMBER FORMWORK DETAILS SHOWN ARE SUGGESTED SIZES AND ARE BASED ON THE AMERICAN NATIONAL STANDARD FOR SHORING AND FORMING EQUIPMENT. USE CONTENT DESIGN ASSUMES A MAX OF 10% WITH ADJUSTMENTS FOR SHORT DURATION LOADING.
9. EXTREME FIBER STRESS IS SENSITIVE BEFORE ADJUSTMENTS. 150 PSI MODULES OF ELASTICITY 1,700,000 PSI
10. STRESS FOR MICROPLUM TRUSS JOIST WOOD - 1 (BEAMS) 2,000 PSI 144 PSI 2,000,000 PSI
11. TENSION PARALLEL TO THE GRAIN 1,440 PSI 144 PSI 2,000,000 PSI
12. MODULES OF ELASTICITY 1,700,000 PSI
13. IN WOOD DESIGN, IS BASED ON AMERICAN WOODWORK ASSOCIATION RECOMMENDATIONS WITH THE FACE GRAIN OF THE WOOD RUNNING AT RIGHT ANGLES TO ITS SUPPORT.

14. THE SHORING SYSTEM AS SHOWN, IS DESIGNED ON THE ASSUMPTION THAT FORMWORK WILL BE RESTRAINED FROM LATERAL MOVEMENT BY THE CONTRACTOR SUFFICIENT LATERAL LOADS ON THE SHORING SYSTEM.
15. THE SHORING EQUIPMENT DIRECTED IN CONNECTION WITH THESE LAYOUTS, MUST BE IN ACCORDANCE WITH THE FOLLOWING SCAFFOLD, SHORING AND FORMING INSTITUTE DRAWINGS. ONE AND THE FOLLOWING ARE TO BE CONSIDERED AN INTEGRAL PART OF THESE DRAWINGS.
  - A. STEEL FRAME SHORING SAFETY RULES
  - B. RECOMMENDED STEEL FRAME SHORING ERECTION PROCEDURES AS PUBLISHED IN GBS FIELD MANUAL
  - C. SINGLE POST SHORE SAFETY RULES
16. THESE PRINTS ARE THE PROPERTY OF SYMONS CORPORATION AND ARE FURNISHED FOR THE EXCLUSIVE USE OF THE CUSTOMER ON THE CONDITION THAT THEY ARE NOT TO BE COPIED OR USED BY OTHERS WITHOUT SYMONS' PRIOR WRITTEN, WRITTEN, CONSENT.
17. SYMONS CAN SUGGEST METHODS OF REFORMING THE BEAMS. SYMONS CANNOT GUARANTEE APPROVAL OF SUGGESTED REFORMING BY THE STRUCTURAL ENGINEER OF RECORD.
18. MAXIMUM SHORE LEG LOAD AS ILLUSTRATED ON THESE DRAWINGS IS 18 KIP PER LEG FOR TOP JACK FORMING SYSTEM.
19. MAXIMUM SHORE LEG LOAD AS ILLUSTRATED ON THESE DRAWINGS IS 15 KIP PER LEG FOR LOGGY FORMING SYSTEM.
20. MAXIMUM SHORE LEG LOAD AS ILLUSTRATED ON THESE DRAWINGS IS 25 KIP PER LEG FOR TOP JACK FORMING SYSTEM USING THE 50 KIP SHORING FRAME AND HEADER.

- I. POST THESE SINGLE POST SHORES SAFELY IN A COMPANION PLACE and be sure that all persons, who erect, dismantle or use Single Post Shores, are well-informed of the regulations pertaining to shoring.
- II. RESPECT ALL EQUIPMENT BEING USED. Never use any equipment that is damaged.
- III. INSPECT ALL SHORING BEFORE USING. Immediately prior to pour - a. DO NOT EXCEED THE SHORING AND FORMING CAPACITY OF THE SHORING. b. CHECK YOUR SHORING EQUIPMENT SUPPLIER WHEN IN DOUBT.
- IV. A SHORING LAYOUT — Should be available and used on the job site at all times.

- I. POST THESE SINGLE POST SHORES SAFELY IN A COMPANION PLACE and be sure that all persons, who erect, dismantle or use Single Post Shores, are well-informed of the regulations pertaining to shoring.
- II. RESPECT ALL EQUIPMENT BEING USED. Never use any equipment that is damaged.
- III. INSPECT ALL SHORING BEFORE USING. Immediately prior to pour - a. DO NOT EXCEED THE SHORING AND FORMING CAPACITY OF THE SHORING. b. CHECK YOUR SHORING EQUIPMENT SUPPLIER WHEN IN DOUBT.
- IV. A SHORING LAYOUT — Should be available and used on the job site at all times.

- I. POST THESE SINGLE POST SHORES SAFELY IN A COMPANION PLACE and be sure that all persons, who erect, dismantle or use Single Post Shores, are well-informed of the regulations pertaining to shoring.
- II. RESPECT ALL EQUIPMENT BEING USED. Never use any equipment that is damaged.
- III. INSPECT ALL SHORING BEFORE USING. Immediately prior to pour - a. DO NOT EXCEED THE SHORING AND FORMING CAPACITY OF THE SHORING. b. CHECK YOUR SHORING EQUIPMENT SUPPLIER WHEN IN DOUBT.
- IV. A SHORING LAYOUT — Should be available and used on the job site at all times.

- I. POST THESE SINGLE POST SHORES SAFELY IN A COMPANION PLACE and be sure that all persons, who erect, dismantle or use Single Post Shores, are well-informed of the regulations pertaining to shoring.
- II. RESPECT ALL EQUIPMENT BEING USED. Never use any equipment that is damaged.
- III. INSPECT ALL SHORING BEFORE USING. Immediately prior to pour - a. DO NOT EXCEED THE SHORING AND FORMING CAPACITY OF THE SHORING. b. CHECK YOUR SHORING EQUIPMENT SUPPLIER WHEN IN DOUBT.
- IV. A SHORING LAYOUT — Should be available and used on the job site at all times.

- I. POST THESE SINGLE POST SHORES SAFELY IN A COMPANION PLACE and be sure that all persons, who erect, dismantle or use Single Post Shores, are well-informed of the regulations pertaining to shoring.
- II. RESPECT ALL EQUIPMENT BEING USED. Never use any equipment that is damaged.
- III. INSPECT ALL SHORING BEFORE USING. Immediately prior to pour - a. DO NOT EXCEED THE SHORING AND FORMING CAPACITY OF THE SHORING. b. CHECK YOUR SHORING EQUIPMENT SUPPLIER WHEN IN DOUBT.
- IV. A SHORING LAYOUT — Should be available and used on the job site at all times.

- I. POST THESE SINGLE POST SHORES SAFELY IN A COMPANION PLACE and be sure that all persons, who erect, dismantle or use Single Post Shores, are well-informed of the regulations pertaining to shoring.
- II. RESPECT ALL EQUIPMENT BEING USED. Never use any equipment that is damaged.
- III. INSPECT ALL SHORING BEFORE USING. Immediately prior to pour - a. DO NOT EXCEED THE SHORING AND FORMING CAPACITY OF THE SHORING. b. CHECK YOUR SHORING EQUIPMENT SUPPLIER WHEN IN DOUBT.
- IV. A SHORING LAYOUT — Should be available and used on the job site at all times.

- I. POST THESE SINGLE POST SHORES SAFELY IN A COMPANION PLACE and be sure that all persons, who erect, dismantle or use Single Post Shores, are well-informed of the regulations pertaining to shoring.
- II. RESPECT ALL EQUIPMENT BEING USED. Never use any equipment that is damaged.
- III. INSPECT ALL SHORING BEFORE USING. Immediately prior to pour - a. DO NOT EXCEED THE SHORING AND FORMING CAPACITY OF THE SHORING. b. CHECK YOUR SHORING EQUIPMENT SUPPLIER WHEN IN DOUBT.
- IV. A SHORING LAYOUT — Should be available and used on the job site at all times.

- I. POST THESE SINGLE POST SHORES SAFELY IN A COMPANION PLACE and be sure that all persons, who erect, dismantle or use Single Post Shores, are well-informed of the regulations pertaining to shoring.
- II. RESPECT ALL EQUIPMENT BEING USED. Never use any equipment that is damaged.
- III. INSPECT ALL SHORING BEFORE USING. Immediately prior to pour - a. DO NOT EXCEED THE SHORING AND FORMING CAPACITY OF THE SHORING. b. CHECK YOUR SHORING EQUIPMENT SUPPLIER WHEN IN DOUBT.
- IV. A SHORING LAYOUT — Should be available and used on the job site at all times.

- I. POST THESE SINGLE POST SHORES SAFELY IN A COMPANION PLACE and be sure that all persons, who erect, dismantle or use Single Post Shores, are well-informed of the regulations pertaining to shoring.
- II. RESPECT ALL EQUIPMENT BEING USED. Never use any equipment that is damaged.
- III. INSPECT ALL SHORING BEFORE USING. Immediately prior to pour - a. DO NOT EXCEED THE SHORING AND FORMING CAPACITY OF THE SHORING. b. CHECK YOUR SHORING EQUIPMENT SUPPLIER WHEN IN DOUBT.
- IV. A SHORING LAYOUT — Should be available and used on the job site at all times.

- I. POST THESE SINGLE POST SHORES SAFELY IN A COMPANION PLACE and be sure that all persons, who erect, dismantle or use Single Post Shores, are well-informed of the regulations pertaining to shoring.
- II. RESPECT ALL EQUIPMENT BEING USED. Never use any equipment that is damaged.
- III. INSPECT ALL SHORING BEFORE USING. Immediately prior to pour - a. DO NOT EXCEED THE SHORING AND FORMING CAPACITY OF THE SHORING. b. CHECK YOUR SHORING EQUIPMENT SUPPLIER WHEN IN DOUBT.
- IV. A SHORING LAYOUT — Should be available and used on the job site at all times.

- I. POST THESE SINGLE POST SHORES SAFELY IN A COMPANION PLACE and be sure that all persons, who erect, dismantle or use Single Post Shores, are well-informed of the regulations pertaining to shoring.
- II. RESPECT ALL EQUIPMENT BEING USED. Never use any equipment that is damaged.
- III. INSPECT ALL SHORING BEFORE USING. Immediately prior to pour - a. DO NOT EXCEED THE SHORING AND FORMING CAPACITY OF THE SHORING. b. CHECK YOUR SHORING EQUIPMENT SUPPLIER WHEN IN DOUBT.
- IV. A SHORING LAYOUT — Should be available and used on the job site at all times.

- I. POST THESE SINGLE POST SHORES SAFELY IN A COMPANION PLACE and be sure that all persons, who erect, dismantle or use Single Post Shores, are well-informed of the regulations pertaining to shoring.
- II. RESPECT ALL EQUIPMENT BEING USED. Never use any equipment that is damaged.
- III. INSPECT ALL SHORING BEFORE USING. Immediately prior to pour - a. DO NOT EXCEED THE SHORING AND FORMING CAPACITY OF THE SHORING. b. CHECK YOUR SHORING EQUIPMENT SUPPLIER WHEN IN DOUBT.
- IV. A SHORING LAYOUT — Should be available and used on the job site at all times.

- I. POST THESE SINGLE POST SHORES SAFELY IN A COMPANION PLACE and be sure that all persons, who erect, dismantle or use Single Post Shores, are well-informed of the regulations pertaining to shoring.
- II. RESPECT ALL EQUIPMENT BEING USED. Never use any equipment that is damaged.
- III. INSPECT ALL SHORING BEFORE USING. Immediately prior to pour - a. DO NOT EXCEED THE SHORING AND FORMING CAPACITY OF THE SHORING. b. CHECK YOUR SHORING EQUIPMENT SUPPLIER WHEN IN DOUBT.
- IV. A SHORING LAYOUT — Should be available and used on the job site at all times.

- I. POST THESE SINGLE POST SHORES SAFELY IN A COMPANION PLACE and be sure that all persons, who erect, dismantle or use Single Post Shores, are well-informed of the regulations pertaining to shoring.
- II. RESPECT ALL EQUIPMENT BEING USED. Never use any equipment that is damaged.
- III. INSPECT ALL SHORING BEFORE USING. Immediately prior to pour - a. DO NOT EXCEED THE SHORING AND FORMING CAPACITY OF THE SHORING. b. CHECK YOUR SHORING EQUIPMENT SUPPLIER WHEN IN DOUBT.
- IV. A SHORING LAYOUT — Should be available and used on the job site at all times.

- I. POST THESE SINGLE POST SHORES SAFELY IN A COMPANION PLACE and be sure that all persons, who erect, dismantle or use Single Post Shores, are well-informed of the regulations pertaining to shoring.
- II. RESPECT ALL EQUIPMENT BEING USED. Never use any equipment that is damaged.
- III. INSPECT ALL SHORING BEFORE USING. Immediately prior to pour - a. DO NOT EXCEED THE SHORING AND FORMING CAPACITY OF THE SHORING. b. CHECK YOUR SHORING EQUIPMENT SUPPLIER WHEN IN DOUBT.
- IV. A SHORING LAYOUT — Should be available and used on the job site at all times.

- I. POST THESE SINGLE POST SHORES SAFELY IN A COMPANION PLACE and be sure that all persons, who erect, dismantle or use Single Post Shores, are well-informed of the regulations pertaining to shoring.
- II. RESPECT ALL EQUIPMENT BEING USED. Never use any equipment that is damaged.
- III. INSPECT ALL SHORING BEFORE USING. Immediately prior to pour - a. DO NOT EXCEED THE SHORING AND FORMING CAPACITY OF THE SHORING. b. CHECK YOUR SHORING EQUIPMENT SUPPLIER WHEN IN DOUBT.
- IV. A SHORING LAYOUT — Should be available and used on the job site at all times.

- I. POST THESE SINGLE POST SHORES SAFELY IN A COMPANION PLACE and be sure that all persons, who erect, dismantle or use Single Post Shores, are well-informed of the regulations pertaining to shoring.
- II. RESPECT ALL EQUIPMENT BEING USED. Never use any equipment that is damaged.
- III. INSPECT ALL SHORING BEFORE USING. Immediately prior to pour - a. DO NOT EXCEED THE SHORING AND FORMING CAPACITY OF THE SHORING. b. CHECK YOUR SHORING EQUIPMENT SUPPLIER WHEN IN DOUBT.
- IV. A SHORING LAYOUT — Should be available and used on the job site at all times.

- I. POST THESE SINGLE POST SHORES SAFELY IN A COMPANION PLACE and be sure that all persons, who erect, dismantle or use Single Post Shores, are well-informed of the regulations pertaining to shoring.
- II. RESPECT ALL EQUIPMENT BEING USED. Never use any equipment that is damaged.
- III. INSPECT ALL SHORING BEFORE USING. Immediately prior to pour - a. DO NOT EXCEED THE SHORING AND FORMING CAPACITY OF THE SHORING. b. CHECK YOUR SHORING EQUIPMENT SUPPLIER WHEN IN DOUBT.
- IV. A SHORING LAYOUT — Should be available and used on the job site at all times.

GENERAL SET OF FIELD DRAWINGS

<p>SYMONS CORPORATION 1100 CHURCH ST. DAYTON, OH 45424 PHONE: 513-233-1000 FAX: 513-233-1004</p>	<p>SYMONS BY DAYTON SUPERIOR</p>	<p>GBS-2 2015</p>
<p>SYMONS - Garage Beam System Safety Cover Sheet</p>	<p>SYMONS BY DAYTON SUPERIOR</p>	<p>GBS-2 2015</p>



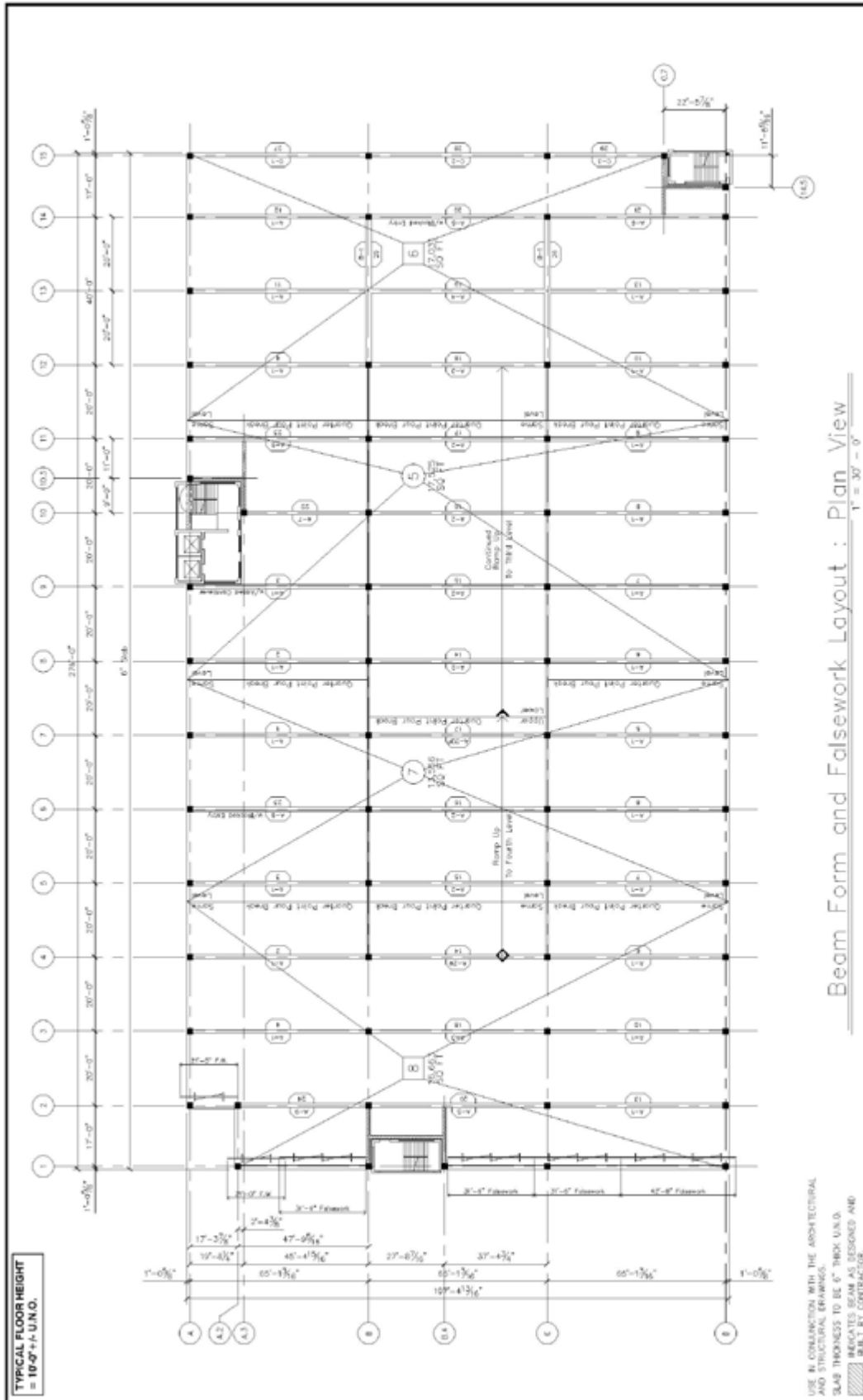

<p>THIS DRAWING IS THE PROPERTY OF SYMONS BY DAYTON SUPERIOR. IT IS TO BE USED ONLY FOR THE PROJECT AND SITE SPECIFICALLY IDENTIFIED HEREON. IT IS NOT TO BE REPRODUCED, COPIED, OR TRANSMITTED IN ANY FORM OR BY ANY MEANS, ELECTRONIC OR MECHANICAL, INCLUDING PHOTOCOPYING, RECORDING, OR BY ANY INFORMATION STORAGE AND RETRIEVAL SYSTEM, WITHOUT THE WRITTEN PERMISSION OF SYMONS BY DAYTON SUPERIOR.</p>	<p>DATE: 03/11/15 JOB NO: 00000003 PROJECT: 137-14000-10000</p>	<p>SYMONS BY DAYTON SUPERIOR F-1.0 REVISED: 03/11/15</p>
<p>PROJECT: GBS Example Job Parking Structure</p>	<p>DATE: 03/11/15 JOB NO: 00000003 PROJECT: 137-14000-10000</p>	<p>SYMONS BY DAYTON SUPERIOR F-1.0 REVISED: 03/11/15</p>
<p>DATE: 03/11/15 JOB NO: 00000003 PROJECT: 137-14000-10000</p>	<p>DATE: 03/11/15 JOB NO: 00000003 PROJECT: 137-14000-10000</p>	<p>SYMONS BY DAYTON SUPERIOR F-1.0 REVISED: 03/11/15</p>

# Sample Beam Form and Falsework Layout Drawing

GENERAL SET OF FIELD DRAWINGS













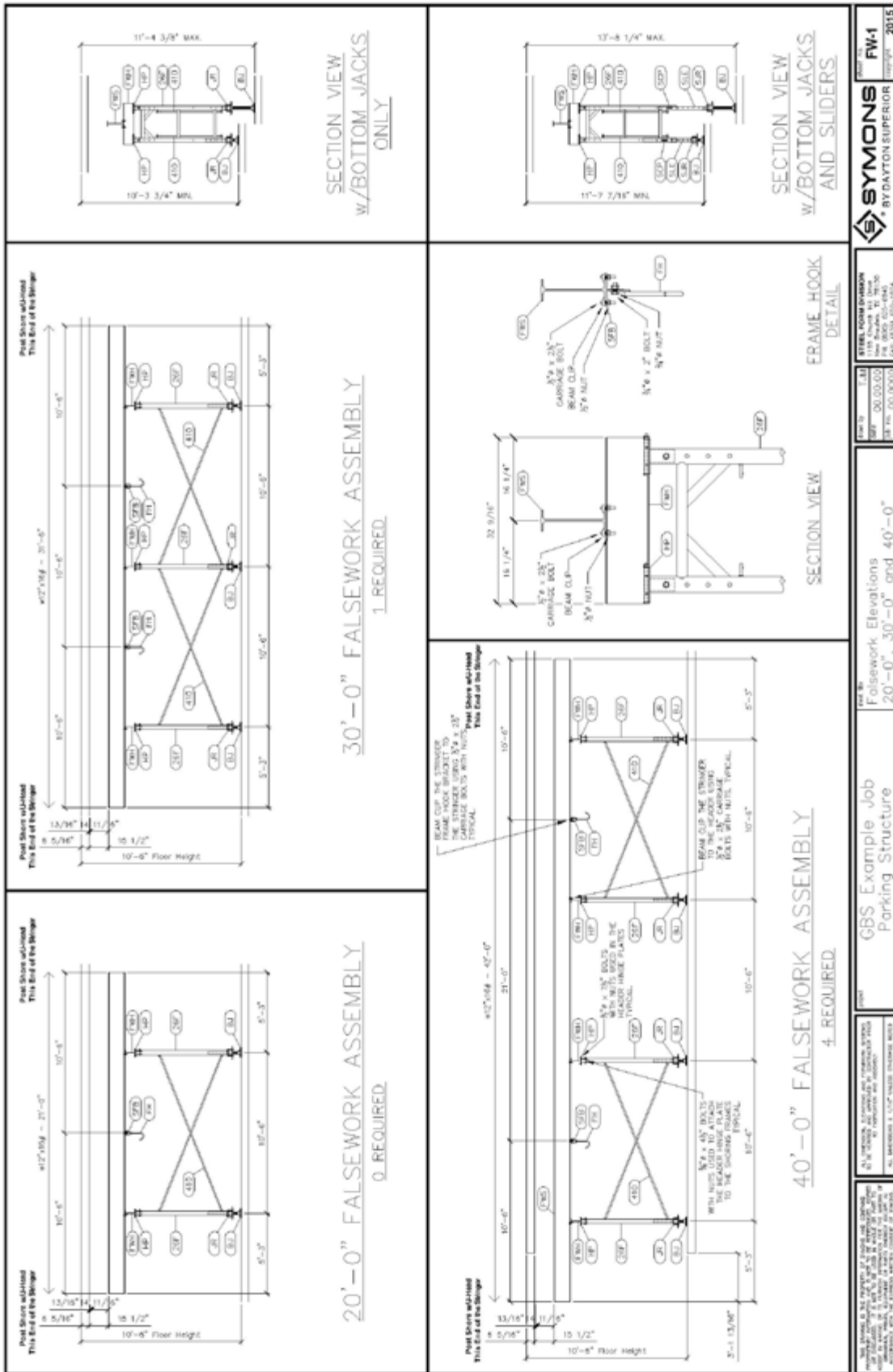

GENERAL SET OF FIELD DRAWINGS



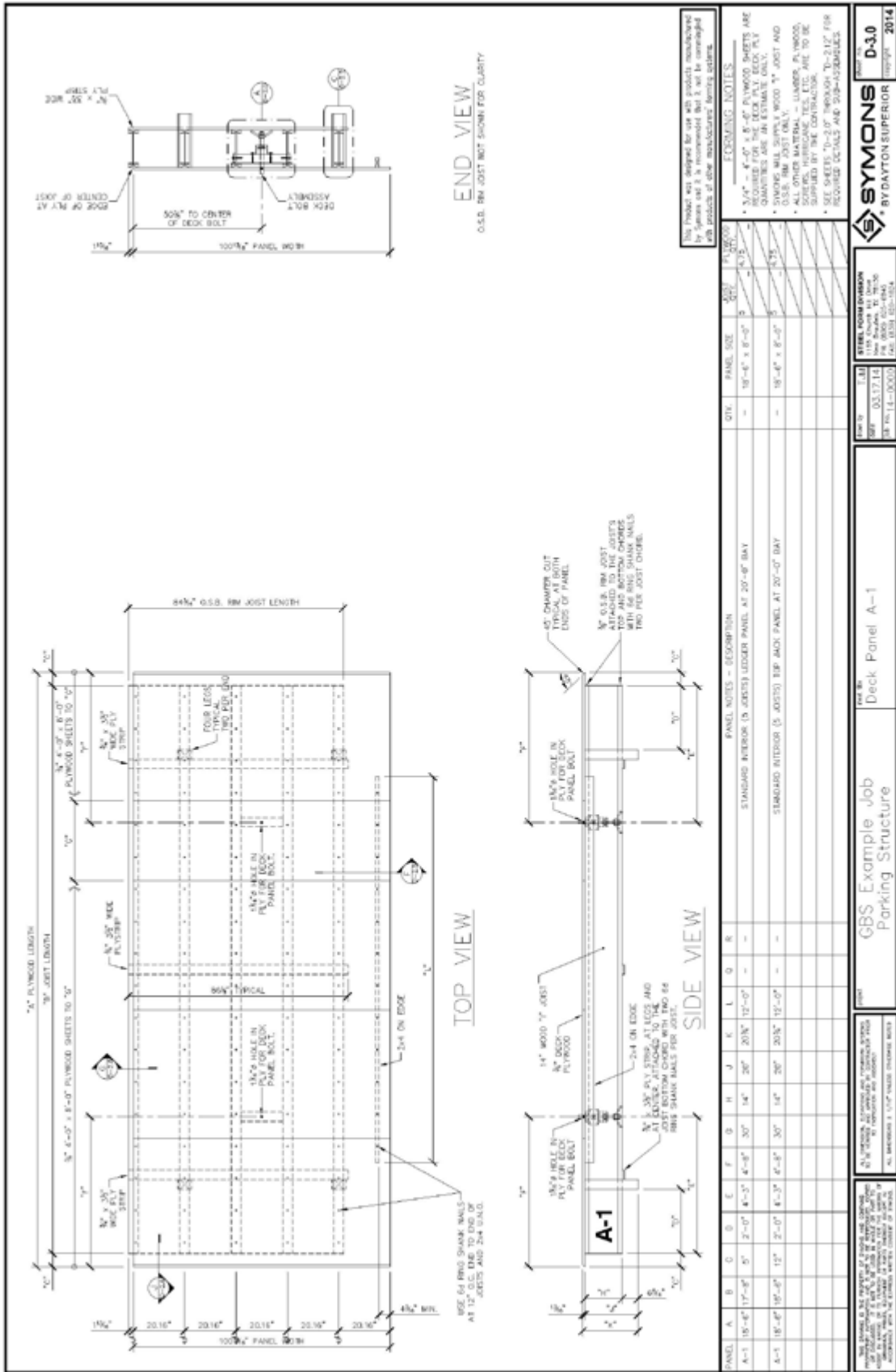

Sample Interior Deck Panel Assembly Drawing

GENERAL SET OF  
FIELD DRAWINGS





































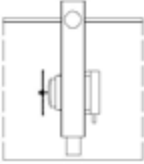





## Beam Form Assembly Tool List

	Tool	Used For	Qty. Req'd
A.	Gas Forklift(s)	Transportation	1 / 2
B.	Electrical Power Supply	Electrical Power	1
C.	5 H.P. Air Compressor (Optional)	Air Supply (Optional)	1
1.	 3/4" Drive Impact Wrench (Electric or Air)	Formwork Make-Up	1
2.	 3/8" Drive Reversible Drill (Electric or Air)	Attachment of Nailers	1
3.	 3/4" Drive Long Handle Reversible Ratchet Wrench	Production Work	3
4.	 1/2" Drive Standard Reversible Ratchet Wrench	Attachment of Nailers and Jack Retainers	3
5.	 1 1/4" 6 Point Heavy Duty Impact Socket with 3/4" Drive	3/4" Heavy Hex A-325 Bolts and Nuts	3
6.	 3/4" 6 Point Standard Socket with 1/2" Drive	1/2" Bolts and Nuts	3
7.	 9/16" 6 Point Deep Socket with 1/2" drive	3/8" Nuts for Carriage Bolts Used For Nailers	3
8.	 15/16" 6 Point Standard Socket with 1/2" Drive	5/8" Bolts and Nuts	3
9.	 7/16" Diameter Drill Bit	For Drilling Nailers	3
10.	 1/4" Long Arm Allen Wrench	Jack Retainer Cap Screw	3
11.	 15" Adjustable Wrench	Miscellaneous Uses	1
12.	 1 1/4" Iron Worker's Structural Wrench (Spud Wrench)	Formwork Make-Up	2
13.	 Pinch Point Crowbar	Beam Alignment	2
14.	 Gooseneck Claw & Pinch Bar	Beam Alignment	1
15.	 Small Wrecking & Pry Bar	Beam Shimming	1
16.	 100' Extension Cord	Electrical Power Supply	2
17.	 12-Ton Hydraulic Bottle Jack	Stripping Beam Forms Stripping Transfer Girders	2 / 6
18.	 6" "C" Clamp	Beam Top Alignment and Nailer Attachment	12

**NOTE:** All tools are Contractor Supplied. If tools are not available prior to arrival of GBS personnel, Beam Form build-up will be delayed.

## Deck Panel Assembly Tool List

	Tool	Used For	Qty. Req'd
A.	Gas Forklift	Transportation	1
B.	Electrical Power Supply	Electrical Power	1
C.	5 H.P. Air Compressor (Optional)	Air Supply (Optional)	1
1.	 12" Radial Arm Saw	Joist Cutting	1
2.	 10" Miter Saw	Lumber Cutting	1
3.	 8" Circular Saw	Plywood Cutting	1
4.	 1/2" Drive Impact Wrench (Electric or Air)	Production Work	1
5.	 3/8" Drive Reversible Drill (Electric or Air)	Drilling the Deck Bolt Hole and Pilot Holes as Required	2
6.	 Framing Nail Gun (Electric, Air or Gas)	Nailing Applications	1
7.	 2 1/2 H.P. 1/2" Cullet Router	Chamfering the Plywood Edges	1
8.	 1/2" Drive Standard Reversible Ratchet Wrench	Production Work	1
9.	 9/16" 6 Point Standard Socket with 1/2" Drive	Attaching The Deck Bolt Mounts	3
10.	 1/4" Diameter Drill Bit	Pilot Holes as Required	3
11.	 1 1/16" Diameter Auger Bit x 12" Long	Drilling the Deck Bolt Hole	2
12.	 1/2" Shank Carbide Tip 5/8"-45 Degree Chamfering Bit	Chamfering the Plywood Edges	3
13.	 50' Extension Cord	Electric Supply	4
14.	 100' Extension Cord	Electric Supply	1

**NOTE:** All tools are Contractor supplied. If tools are not available prior to arrival of GBS personnel, Deck Panel build-up will be delayed.

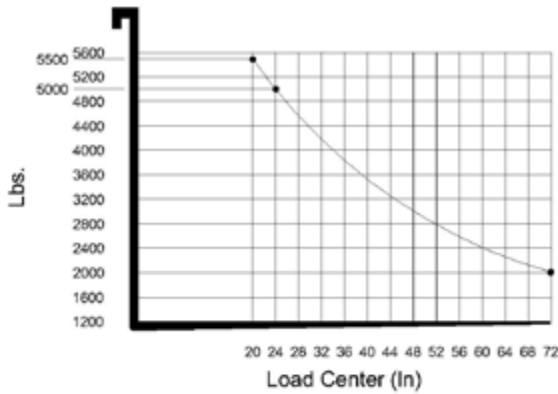

### Load Capacity Chart

Rated capacities are computed from front face of forks with mast in vertical position and apply to Wide Span Mast with up to 157.5" maximum fork height

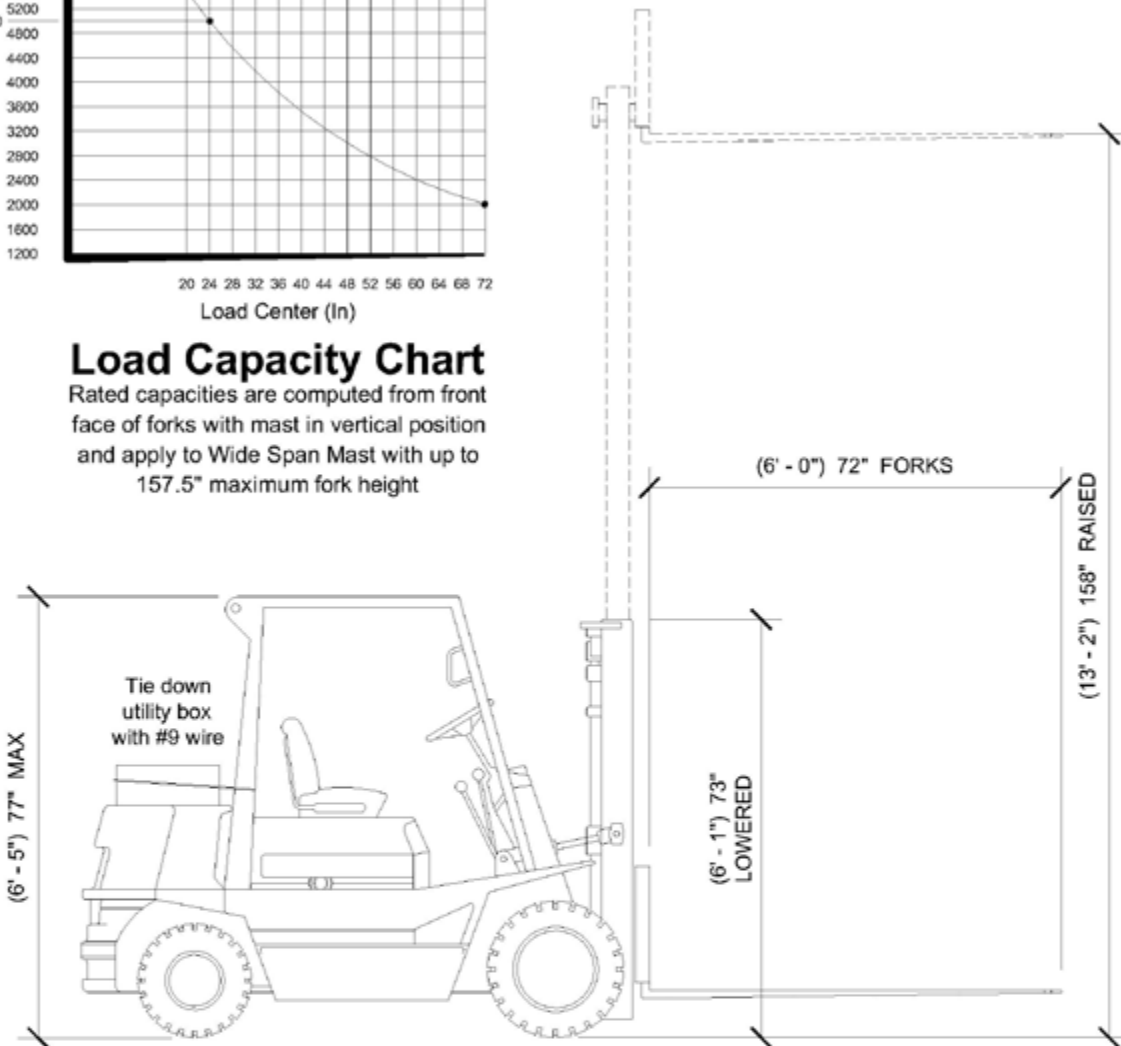

### Gas Forklift

Weight: 8500 lb.

Capacity: 5000 lb. @ 24" load center

It is a good idea to keep the following items in the utility box at all times:

1. Extra Nuts and Bolts
2. Extra Jack Retainers
3. Extra Frame Hooks
4. Spud Wrenches
5. Allen Wrenches
6. Tie-Wire

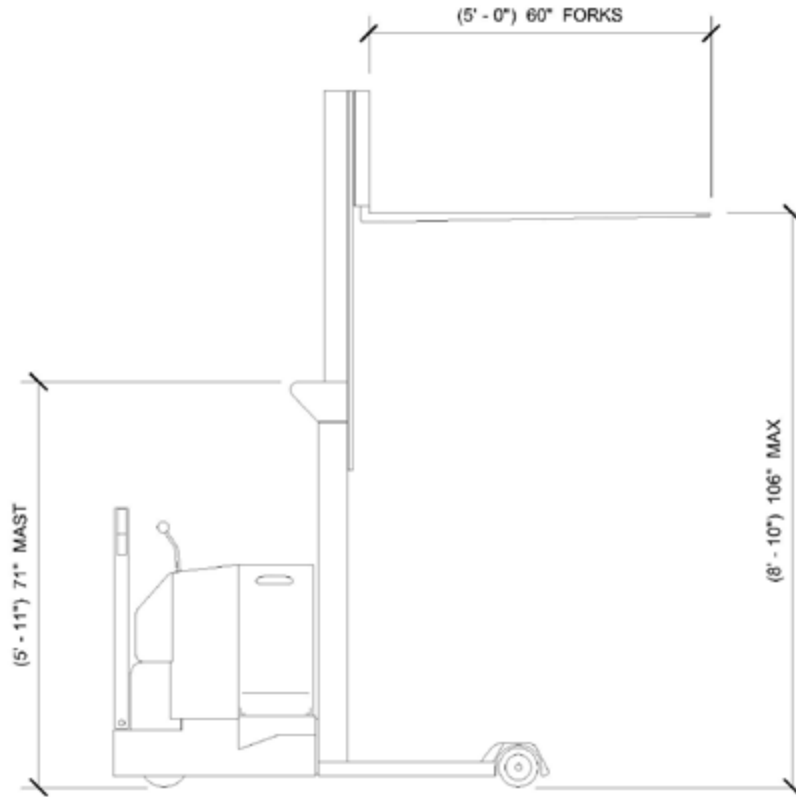

TOOLS, EQUIPMENT &  
ASSEMBLY DETAILS

### Electric Forklift

Weight: 2800 lb.

Capacity: 4000 lb. @ 24" load center

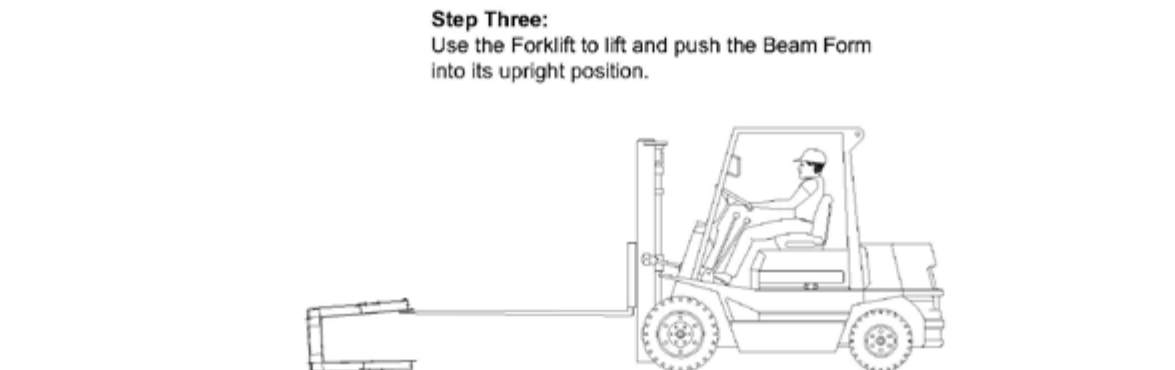
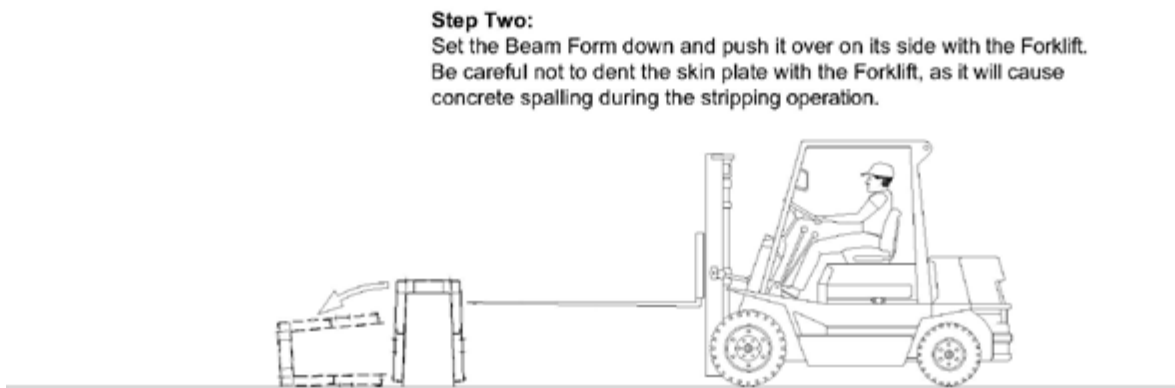
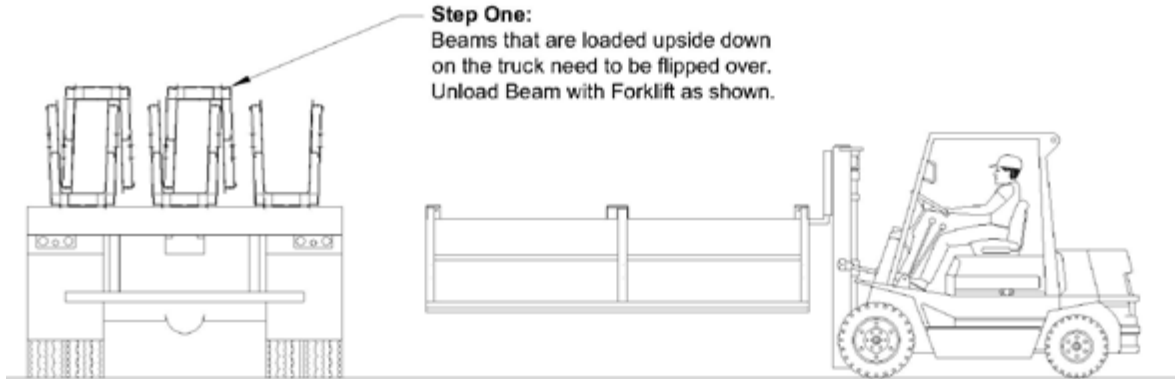

## Beam Form Handling

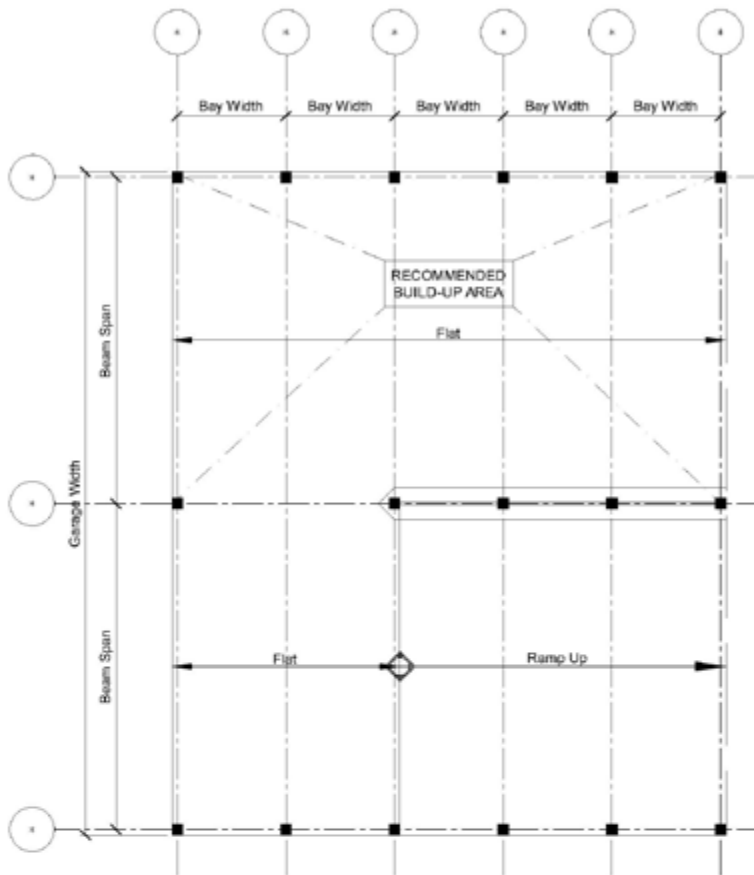

**Notes:**

1. THE STAGING AND BUILD-UP AREA SHOULD BE LOCATED BELOW THE LAST POUR ON THE SLAB ON GRADE. THIS ALLOWS ENOUGH TIME TO BUILD-UP ALL THE BEAM FORMS BEFORE HAVING TO MOVE.
2. THE AREA SHOULD BE FLAT AS POSSIBLE WITH LITTLE OR NO ELEVATION CHANGES OR DRAINAGE SLOPES.
3. DO NOT BUILD-UP THE BEAMS BETWEEN TWO COLUMNS BECAUSE THIS WILL BLOCK ACCESS TO THE REST OF THE GARAGE.
4. IF NO ADEQUATE AREA IS AVAILABLE ON THE SLAB ON GRADE, THEN IT IS SUGGESTED THAT A 6'-0" x 62'-0" WASTE SLAB IS POURED SOMEWHERE CONVENIENT ON THE JOB SITE TO ALLOW FOR THE PROPER BUILD-UP OF THE BEAM FORMS.

**Slab On Grade Build-Up Area**



**Waste Slab Build-Up Area**

**Staging and Build-Up Area**

TOOLS, EQUIPMENT & ASSEMBLY DETAILS

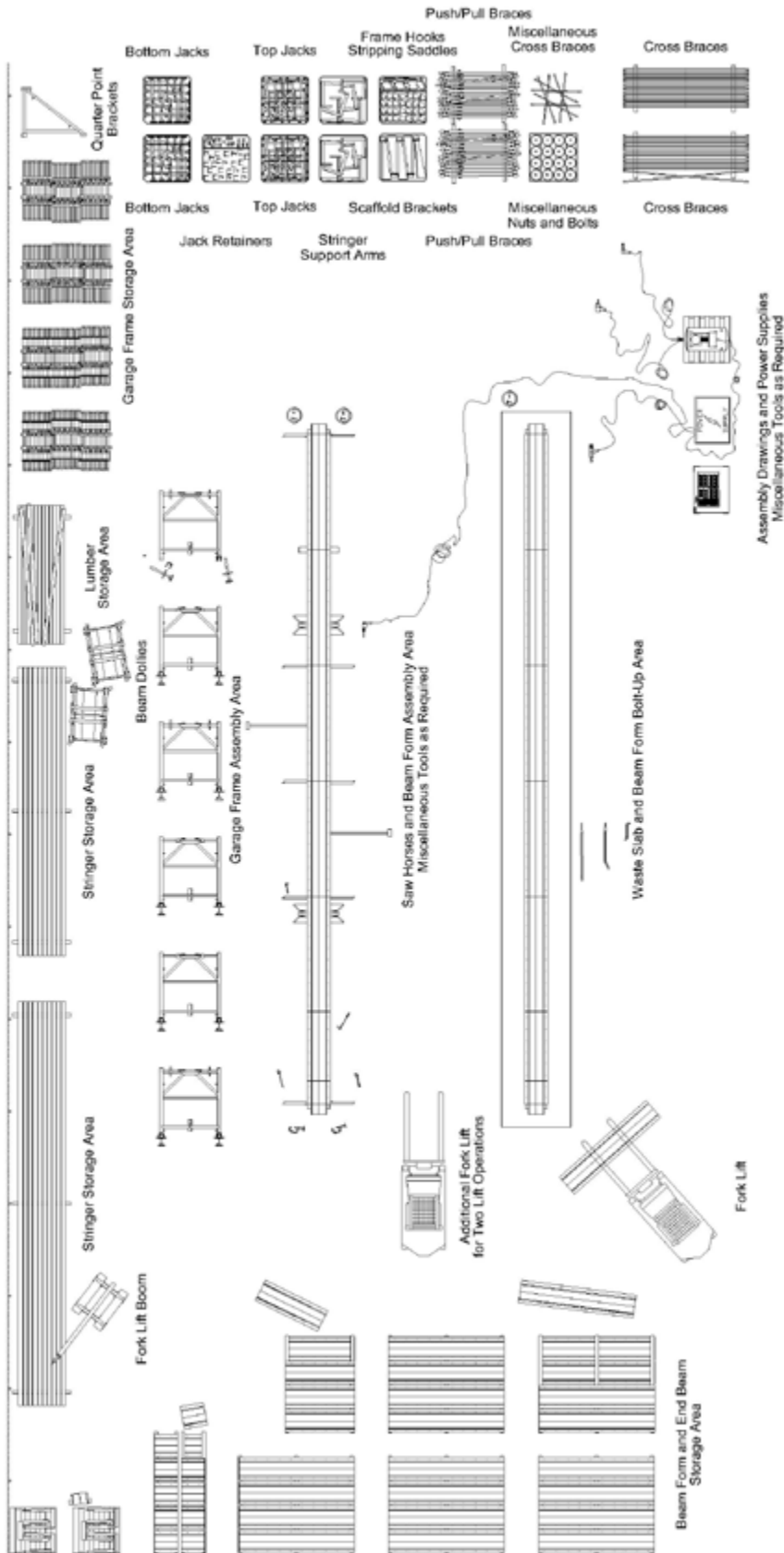

## Top Jack System Suggested Yard Layout

## GBS Top Jack System Beam Assembly Procedures

- A. The following Beam Assembly procedures will require three (3) 2-man crews and one (1) Forklift operator, for a total of seven (7) men. (Note: an additional Forklift and operator are required during two lift operations).
- B. Before starting any Beam Form Assemblies:
  - You should have all of the Tools on the Beam Form Assembly List (See page C-1).
  - There should be a designated Beam Form Assembly Staging and Build-Up Area (See pages C-6 and C-7).
  - You should have all of the supplied GBS Beam Elevation Drawings (B-1.xx Series Drawings).
  - You should have the Beam Form bolt-up Standards (See sheets B-3.0, B-3.1 and B-3.2).
1. Transport and line up the required Beam Forms according to the Beam Elevation Drawings.
2. The first crew bolts the Beam Forms together and strings the assembly for straightness (See pages C-19, C-20 and C-21).
3. After the Beam Assembly is checked for straightness, the finished Beam Assembly is lifted by two forklifts and moved over to the component attachment area where it is set on sawhorses.
4. Now with the Beam Assembly at working height, the second crew attaches the 2x4 lumber nailers and ant required build-ups to the top flange of the Beam Form as required (See pages C-22, C-23 and C-24).
5. While the second crew is attaching the 2x4 lumber nailers, the first crew bolts on the End Beams and the required Beam side components (i.e. Stringer Support Arms, Stripping Saddles and Scaffold Brackets) as designated on the individual Beam Elevations Drawings (See pages C-25, C-26, C-27, C-29 and C-30).
6. The third crew assembles the Bottom Jacks and Jack Retainers into the required GBS Adjustable or Center-Load Frames (See page C-31), no Top Jacks required at this time. The pre-assembled Frame assemblies can then be placed standing up against a column until they are needed.
7. With the Beam Assembly ready for the GBS Garage Frames to be attached (See page C-34), use two Forklifts to lift the Beam Assembly up to a comfortable work height (Approximately 6'-0").
8. Attach the two Frames that are required at each end of the Beam Form (see page C-32) and add 45 degree push/pull braces to plumb the Frames (make sure that the tabs on the Adjustable Frames are pointed in the direction indicated on the Beam Elevation Drawings). Forklifts can now release and are free to leave.
9. At this time, with the Beam Assembly elevated and free standing on the two end Frames, insert the fit-up Bolts into the bottom end flange holes of all of the Beam Form connections and impact the nuts on.
10. The Forklift now carries over the remaining GBS Frames for attachment. The remaining Frames should be attached to the Beam Forms but not be impacted until the Cross Braces are attached.
11. Place the required Cross Braces onto the GBS Frames and use them to help square the Frames to the Beam Forms. When complete, impact the fit-up Bolts on the remainder of the GBS Frames.
12. Bolt the Frame Hooks to the Beam Forms at the locations as indicated on the Beam Elevation Drawings. Pay close attention to the direction of the Frame Hooks, as this relates to the folding of the Frames.
13. Remove the interior Cross Braces and fold up the interior GBS Frames to the appropriate Frame Hooks.
14. With the Beam Dollies in place on the forks of two Forklifts, position the Beam Dollies under the Beam Assembly and raise the Dollies up to engage the soffit of the Beam Form.
15. While supporting the Beam Assembly with the two Forklifts, fold up the two end GBS Frames to the Frame Hooks and lower the Beam Assembly to the ground (See page C-49).
16. Place the Top Jacks into the tops of all of the GBS Frames.
17. Using the Forklift Boom, place the required w8"x15# Stringers onto the Stringer Support Arms on both sides of the Beam Assembly. Note that the Stringers must be attached securely to the Top Jack U-head during all system procedures, such as, setting, during concrete placement, stripping and transporting (See page C-42).
18. Mark the completed Beam Assembly (as per Beam Elevation Drawings) and transport to its first use location.



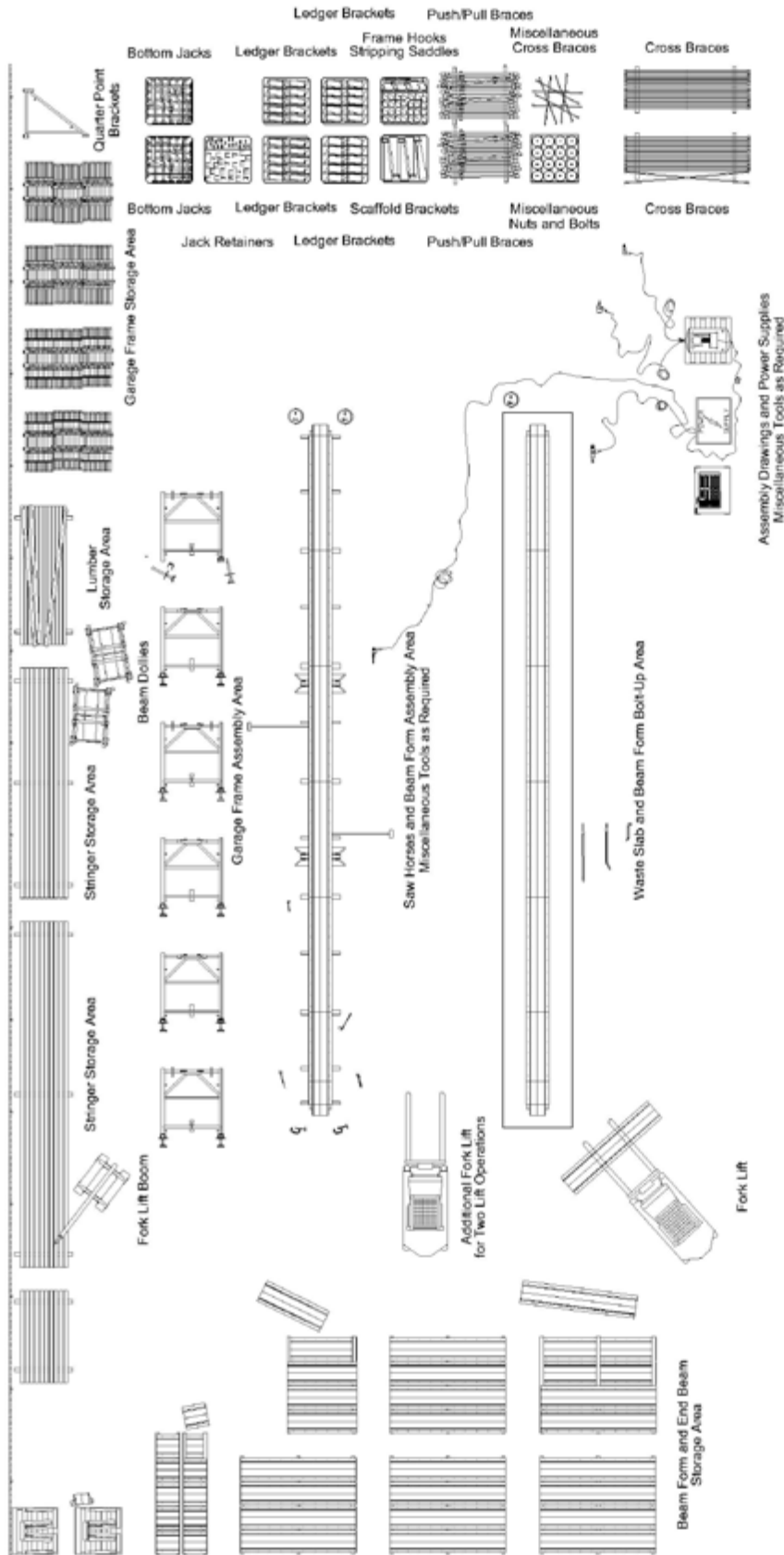

## Ledger System Suggested Yard Layout

## GBS Ledger System Beam Assembly Procedures

- A. The following Beam Assembly procedures will require three (3) 2-man crews and one (1) Forklift operator, for a total of seven (7) men. (Note: an additional Forklift and operator are required during two lift operations).
- B. Before starting any Beam Form Assemblies:
- You should have all of the Tools on the Beam Form Assembly List (See page C-1).
  - There should be a designated Beam Form Assembly Staging and Build-Up Area (See pages C-6 and C-9).
  - You should have all of the supplied GBS Beam Elevation Drawings (B-1.xx Series Drawings).
  - You should have the Beam Form bolt-up Standards (See sheets B-3.0, B-3.1 and B-3.2).
1. Transport and line up the required Beam Forms according to the Beam Elevation Drawings.
  2. The first crew bolts the Beam Forms together and strings the assembly for straightness (See pages C-19, C-20 and C-21).
  3. After the Beam Assembly is checked for straightness, the finished Beam Assembly is lifted by two forklifts and moved over to the component attachment area where it is set on sawhorses.
  4. Now with the Beam Assembly at working height, the second crew attaches the 2x4 lumber nailers and any required build-ups to the top flange of the Beam Form as required (See pages C-22, C-23 and C-24).
  5. While the second crew is attaching the 2x4 lumber nailers, the first crew bolts on the End Beams and the required Beam side components (i.e. Level Ledger Brackets, "Up" Ledger Brackets, "Down" Ledger Brackets and Scaffold Brackets) as designated on the individual Beam Elevations Drawings (See pages C-25, C-28, C-29 and C-30).
  6. The third crew assembles the Bottom Jacks and Jack Retainers into the required GBS adjustable or Center-Load frames (See page C-29). The pre-assembled Frame assemblies can then be placed standing up against a column until needed.
  7. After procedure 5 is complete, use the Forklift Boom to place the required w8"x10# Stringers onto the Ledger Brackets. When in position, attach the Stringers securely to all of the Ledger Brackets on both sides of the Beam Assembly (See page C-43).
  8. With the Beam Assembly ready for the GBS Frames to be attached (See page C-32), use two Forklifts to lift the Beam Assembly to a comfortable work height (Approximately 6'-0").
  9. Attach the two Frames that are required at each end of the Beam Form (See page C-32) and add 45 degree push/pull braces to plumb the Frames (make sure that the tabs on the Adjustable Frames are pointed in the direction indicated on the Beam Elevation Drawings). Forklifts can now release and are free to leave.
  10. At this time, with the Beam Assembly elevated and free standing on the two end Frames, insert the fit-up Bolts into the bottom end flange holes of all of the Beam Forms connections and impact the nuts on.
  11. The Forklift now carries over the remaining GBS Frames for attachment. The remaining Frames should be attached to the Beam Forms but not be impacted until the Cross Braces are attached.
  12. Place the required Cross Braces onto the GBS Frames and use them to help square the Frames to the Beam Forms. When complete, impact the fit-up Bolts on the remainder of the GBS Frames.
  13. Bolt the Frame Hooks to the Beam Forms at the locations as indicated on the Beam Elevation Drawings. Pay close attention to the direction of the Frame Hooks, as this relates to the folding of the Frames.
  14. Remove the interior Cross Braces and fold up the interior GBS Frames to the appropriate Frame Hooks.
  15. With the Beam Dollies in place on the forks of two Forklifts, position the Beam Dollies under the Beam Assembly and raise the Dollies up to engage the soffit of the Beam Form.
  16. While supporting the Beam Assembly with the two Forklifts, fold up the two end GBS Frames to the Frame Hooks and lower the Beam Assembly to the ground (See page C-49).
  17. Mark the completed Beam Assembly (as per Beam Elevation Drawings) and transport to its first use location.

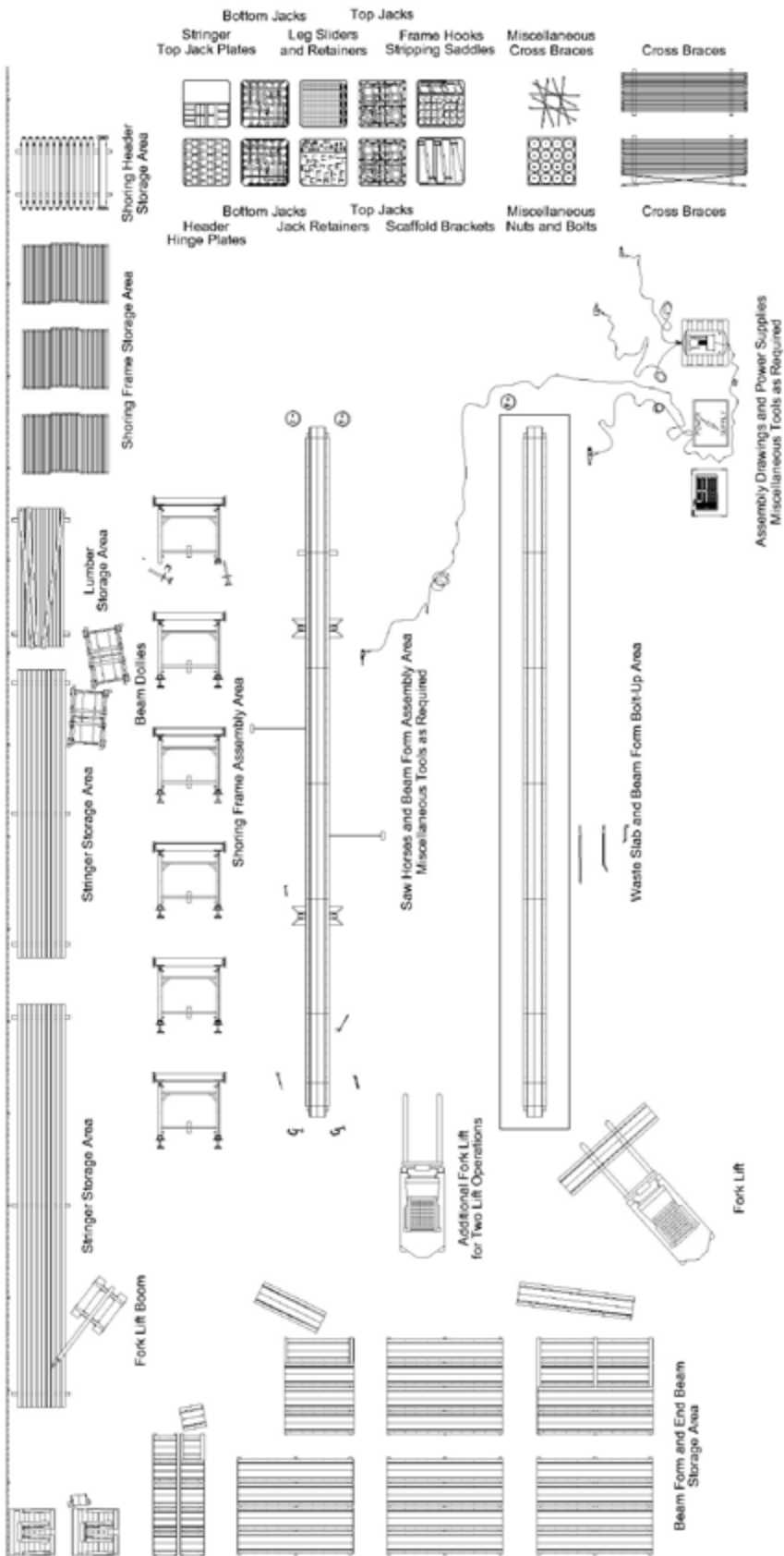

## Header / Top Jack System Suggested Yard Layout

## GBS Header and Top Jack System Beam Assembly Procedures

- A. The following Beam Assembly procedures will require three (3) 2-man crews and one (1) Forklift operator, for a total of seven (7) men. (Note: an additional Forklift and operator are required during two lift operations).
- B. Before starting any Beam Form Assemblies:
- You should have all of the Tools on the Beam Form Assembly List (See page C-1).
  - There should be a designated Beam Form Assembly Staging and Build-Up Area (See pages C-6 and C-11).
  - You should have all of the supplied GBS Beam Elevation Drawings (B-1.xx Series Drawings).
  - You should have the Beam Form bolt-up Standards (See sheets B-3.0, B-3.1 and B-3.2).
1. Transport and lineup the required Beam Forms according to the Beam Elevation Drawings.
  2. The first crew bolts the Beam Forms together and strings the assembly for straightness (See pages C-19, C-20 and C-21).
  3. After the Beam Assembly is checked for straightness, the finished Beam Assembly is lifted by two Forklifts and moved over to the component attachment area where it is set on sawhorses.
  4. Now with the Beam Assembly at working height, the second crew attaches the 2x4 lumber nailers and any required build-ups to the top flange of the Beam Form as required (See pages C-22, C-23 and C-24).
  5. While the second crew is attaching the 2x4 lumber nailers, the first crew bolts on the End Beams and the required Beam side components (i.e. Stripping Saddles and Scaffold Brackets) as designated on the individual Beam Elevations Drawings (See pages C-25, C-27, C-29 and C-30).
  6. The third crew assembles the Bottom Jacks and Jack Retainers into the Shoring Frames (See page C-31). Note that Slider Leg Extensions may be required (See page C-38), and if so, Slider Jack Retainers must also be used instead of the standard Jack Retainers (See page C-31 Similar).
  7. The third crew now attaches the Header Hinge Plates into the top of the Shoring Frames and then attaches the Beam Headers to these Hinge Plates (See page C-38 for both details). The pre-assembled Frame Assemblies can then be placed standing up against a column until they are needed.
  8. With the Beam Assembly ready for the pre-assembled Frame Assemblies, use two Forklifts to lift the Beam Assembly up to a comfortable work height (Approximately 6'-0"). With the Beam Assembly elevated, insert the fit-up Bolts into the bottom end flange holes of all of the Beam Forms connections and impact the nuts on.
  9. At this time, loosely attach all of the Beam Header and Shoring Frame Assemblies that are required to all of all of the Beam Forms using fit-up Bolts and provided 3/4" Beam Clips (See page C-36).
  10. Place the required Cross Braces onto the Shoring Frames and use them to help square the Frames and Headers to the Beam Forms. When complete, impact the fit-up Bolts at each Header location. The Beam can now free stand and the Forklifts can release and are free to leave.
  11. Bolt the Frame Hooks to the Beam Forms at the locations as indicated on the Beam Elevation Drawings. Pay close attention to the direction of the Frame Hooks, as this relates to the folding of the Shoring Frames.
  12. Remove the interior Cross Braces and fold up the interior Shoring Frames to the appropriate Frame Hooks.
  13. With the Beam Dollies in place on the forks of two Forklifts, position the Beam Dollies under the Beam Assembly and raise the Dollies up to engage the soffit of the Beam Form.
  14. While supporting the Beam Assembly with the two Forklifts, fold up the two end Shoring Frames to the Frame Hooks and lower the Beam Assembly to the ground (See page C-49).
  15. Place the Top Jacks into the tops of all of the Beam Headers.
  16. Using the Forklift Boom, place the required w8"x15# Stringers onto the Top Jacks U-Heads on both sides of the Beam Assembly. Note that the Stringers must be attached securely to the Top Jack U-head during all system procedures, such as, setting, during concrete placement, stripping and transporting (See page C-42).
  17. Mark the completed Beam Assembly (as per Beam Elevation Drawings) and transport to its first use location.

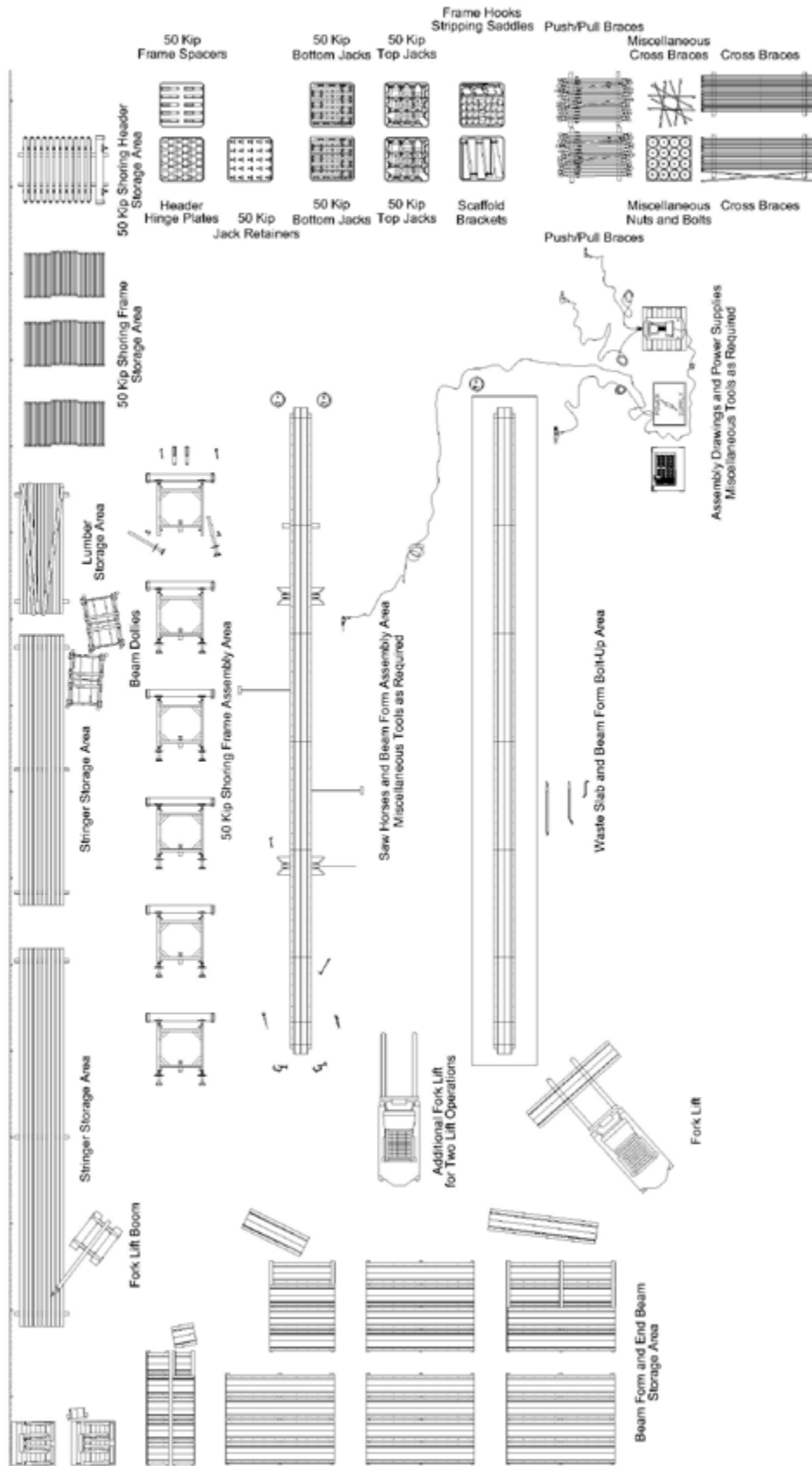

## 50 Kip System Suggested Yard Layout

## GBS 50 Kip System Beam Assembly Procedures

- A. The following Beam Assembly procedures will require three (3) 2-man crews and one (1) Forklift operator, for a total of seven (7) men. (Note: an additional Forklift and operator are required during two lift operations).
- B. Before starting any Beam Form Assemblies:
  - You should have all of the Tools on the Beam Form Assembly List (See page C-1).
  - There should be a designated Beam Form Assembly Staging and Build-Up Area (See pages C-6 and C-13).
  - You should have all of the supplied GBS Beam Elevation Drawings (B-1.xx Series Drawings).
  - You should have the Beam Form bolt-up Standards (See sheets B-3.0, B-3.1 and B-3.2).
1. Transport and lineup the required Beam Forms according to Beam Elevation Drawings.
2. The first crew bolts the Beam Forms together and strings the assembly for straightness (See pages C-19, C-20 and C-21).
3. After the Beam Assembly is checked for straightness, the finished Beam Assembly is lifted by two Forklifts and moved over to the component attachment area where it is set on sawhorses.
4. Now with the Beam Assembly at working height, the second crew attaches the 2x4 lumber nailers and ant required build-ups to the top flange of the beam form as required (See pages C-22, C-23 and C-24).
5. While the second crew is attaching the 2x4 limber nailers, the first crew bolts on the End Beams and the required Beam side components (i.e. Stripping Saddles and Scaffold Brackets) as designated on the individual Beam Elevations Drawings (See pages C-25, C-27, C-29 and C-30).
6. The third crew assembles the 25 Kip Bottom Jacks and Jack Retainers into the 50 Kip Shoring Frames (See page C-47).
7. The third crew now attaches the Header Hinge Plates into the top of the 50 Kip Shoring Frames and then attaches the 50 Kip Headers to these Hinge Plates (See page C-38 similar for both details).
8. At this time, attach the 50 Kip Frame Spacers to the 50 Kip headers (See page C-45), if they are required per the Beam Elevation Drawings, if they are not required, skip this step. The pre-assembled Frame Assemblies can then be placed standing up against a column until they are needed.
9. With the Beam Assembly ready for the pre-assembled 50 Kip Frame Assemblies, use two Forklifts to lift the Beam Assembly to a comfortable work height (Approximately 6'-0"). With the Beam Assembly elevated, insert the fit-up Bolts into the bottom end flange holes of all of the Beam Forms connections and impact the nuts on.
10. At this time, loosely attach all of the 50 Kip Header and Shoring Frame Assemblies that are required to all of all of the Beam Forms using "U"-Bolts for direct placement (See page C-44) or fit-up Bolts when Spacers are required (See page C-45).
11. Place the required Cross Braces onto the Shoring Frames and use them to help square the Frames and Headers to the Beam Forms. When complete, impact the fit-up Bolts at each Header location. The Beam can now free stand and the Forklifts can release and are free to leave.
12. Bolt the Frame Hooks to the Beam Forms at the locations as indicated on the Beam Elevation Drawings. Pay close attention to the direction of the Frame Hooks, as this relates to the folding of the Shoring Frames.
13. Remove the interior Cross Braces and fold up the interior Shoring Frames to the appropriate Frame Hooks.
14. With the Beam Dollies in place on the forks of two Forklifts, position the Beam Dollies under the Beam Assembly and raise the Dollies up to engage the soffit of the Beam Form.
15. While supporting the Beam Assembly with the two Forklifts, fold up the two end Shoring Frames to the Frame Hooks and lower the Beam Assembly to the ground (See page C-49).
16. Place the 25 Kip Top Jacks into the tops of all of the 50 Kip Headers.
17. Using the Forklift Boom, place the required w8"x15# Stringers onto the 25 Kip Top Jacks U-Heads on both sides of the Beam Assembly. Note that the Stringers must be attached securely to the 25 Kip Top Jack U-head during all system procedures, such as, setting, during concrete placement, stripping and transporting (See page C-46).
18. Mark the completed Beam Assembly (as per Beam Elevation Drawings) and transport to its first use location.

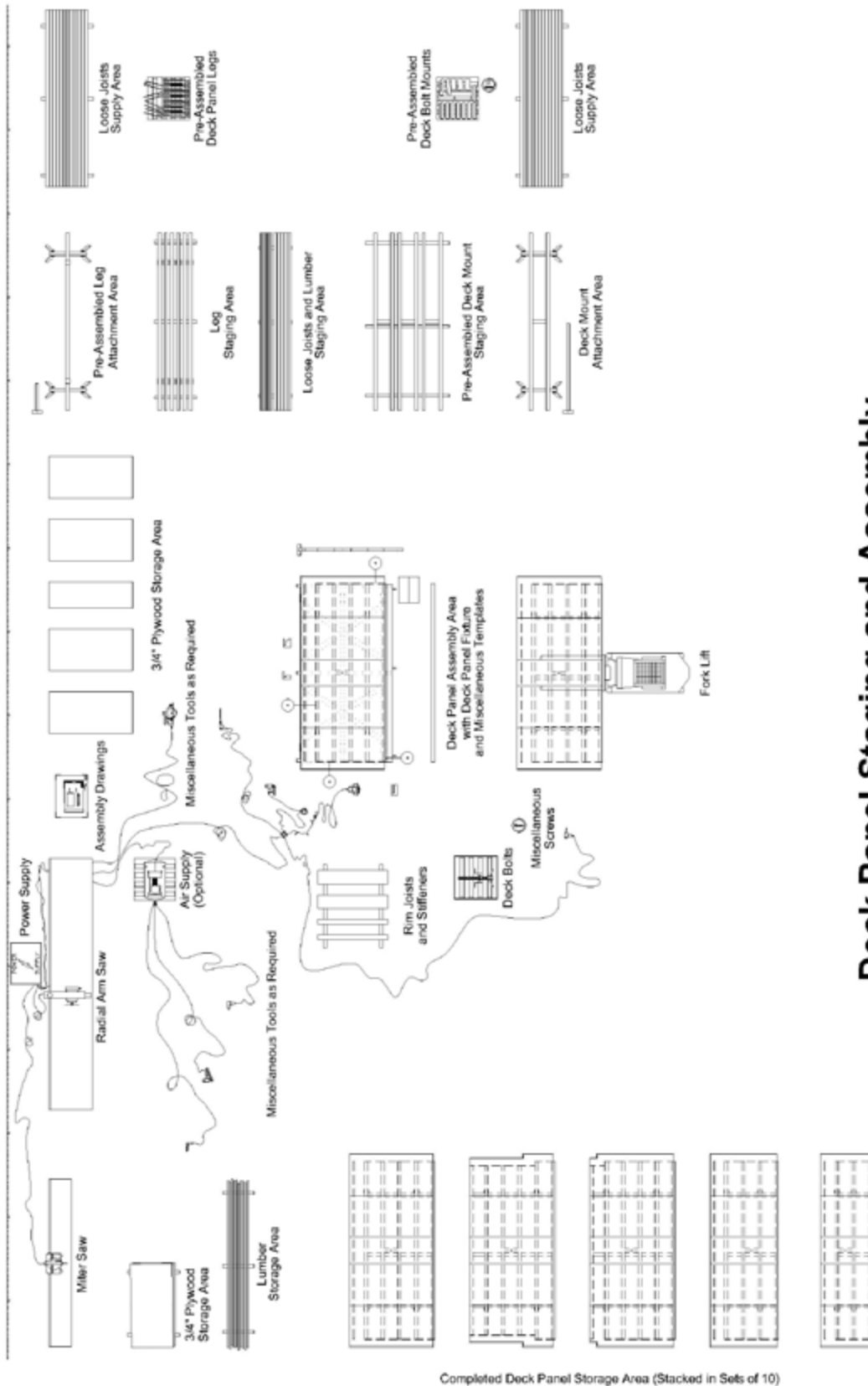

## Deck Panel Staging and Assembly Suggested Yard Layout

## GBS Deck Panel Assembly Procedures

- A. The following Deck Panel Assembly procedures will require four (4) carpenters, one (1) saw man, One (1) laborer and one (1) Forklift operator, for a total of seven (7) men.
- B. Before starting any Deck Panel Assemblies:
  - You should have all of the Tools on the Deck Panel Assembly List (See page C-2).
  - There should be a designated Deck Panel Assembly Staging and Build-Up Area (see page C-15).
  - The Deck Panel Fixture should be completed and staked down in the designated work area of the job site (See sheets D-1.0 and D-1.1 of the Deck Panel Standards Drawings) and all of the Deck Panel Fixture and Assembly Templates should be pre-assembled and ready to use (See sheets D-1.0 and D-1.2 of the Deck Panel Standards Drawings).
  - You should have all of the Deck Panel Standard Drawings (D-2.0 through D-2.13...all of the Standard Drawings may not apply, and therefore will not be included within a specific Job Drawing Package).
  - You should have all of the supplied Deck Panel Assembly Drawings (D-3.xx Series Drawings).
1. First thing in the morning the four (4) carpenters are divided into two (2) teams, with two (2) of the four (4) carpenters working on pre-assembling an adequate number of Deck Panel Deck Bolt Mounts (See sheet D-2.0 of the Deck Panel Standards). The other two (2) carpenters do the same thing for the pre-assembled Deck Panel Legs (See sheet D-2.2 of the Deck Panel Standards).
2. Then in the afternoon, all four (4) carpenters come together and use these pre-assembled components, along with the rest of the required parts, and start to assemble the Deck Panels as they are detailed on the individual Deck Panel Assembly Drawings (D-3.xx series of Drawings) and according to the Deck Panel Standards (D-2.xx series of Drawings).
3. Start by building the Deck Panels by following all of the procedures listed on sheet "D-1.0" of the Deck Panel Standards. Be sure to check each of the Joists to make sure that the "camber" (if present) is facing up. Also it is a good idea to alternate every other sheet of 3/4" Plywood 180 degrees as it comes off of the stack to assure total squareness.
4. Place the first piece of 3/8" O.S.B. Rim Joist into position in the Deck Panel Fixture.
5. Place the first Joist into position into the pockets of the Deck Panel Fixture.
6. Place the second Joist (with the pre-assembled Deck Panel Legs) into the pockets of the Deck Panel Fixture.
7. Place the third and fourth Joists (with the pre-assembled Deck Bolt Mount) into the pockets of the Deck Panel Fixture.
8. Place the fifth Joist (with the pre-assembled Deck Panel Legs) into the pockets of the Deck Panel Fixture.
9. Place the sixth Joist (if required) into the pockets of the Deck Panel Fixture.
10. Nail the O.S.B. Rim Joist to the ends of all of the Wood "I" Joists on the first end and then position the O.S.B. Rim Joist to the opposite end and attach there as well.
11. Position the first sheet of 3/4" Deck Plywood in place on top of the Wood "I" Joists, (use the over-hang templates to position the Plywood properly) square up and nail in place.
12. Position and nail the remaining sheets of 3/4" Deck Plywood in place on top of the Wood "I" Joists.
13. Using the 2x4 Edge Stiffener Templates, position the 2x4 Edge Joist in position and nail in place.
14. Locate and drill the 1 1/16" Deck Bolt Hole into the top of the 3/4" Deck Plywood and through the Deck Bolt Mount.
15. Use the Forklift to lift the Deck Panel out of the Fixture and attach the 3/4" Plywood Roll-Over Strips to the underside of the Wood "I" Joists.
16. Insert the Deck Bolt into the 1 1/16" Hole that has been drilled into the Deck Bolt Mount attach as required.
17. Label the finished Deck Panel as indicated on the individual Deck Panel Assembly Drawing and move over to the storage area and stack up until needed.
18. All other types of Deck Panels are all assembled in the same manner, with only slight variations.
19. It is a really good idea to study the Deck Panel Assembly Drawings in conjunction with the Deck Panel Layout Drawings.





Completed Capital Assembly Staging Area  
(Place onto Pallets by Assembly Units)

Pallets with individual Capital Assemblies:  
There should be a separate pallet for each of the Capital Assemblies required on the job (See the supplied Capital Assembly Drawings, C-XX Series).

All of the parts that make up each of the Capital Assemblies should be included on that particular pallet, this includes: Friction Collar halves, Steel Capital Entry Panels, Steel Capital Side Panels, Steel Soffit Support Panels, Capital Bolt-On Angles, Capital Bolt-On Angles, Capital Offset Angles and all of the required Fit-Up Bolts.

For Capital Assemblies that are used on the Penmeter, it is a good idea to have a few extra 3/4" Plywood Stressing Backs on the Pallet so that they do not have to be cut each time, as they are often ruined during the stripping procedure.

The 2x4 Nailers should be pre-attached all of the Panels as required.  
Each Pallet should be neatly marked to clearly identify the individual Capital Assembly (See Page E-2 for additional information).

This may take some initial effort, but it is a great time-saver once it is complete.

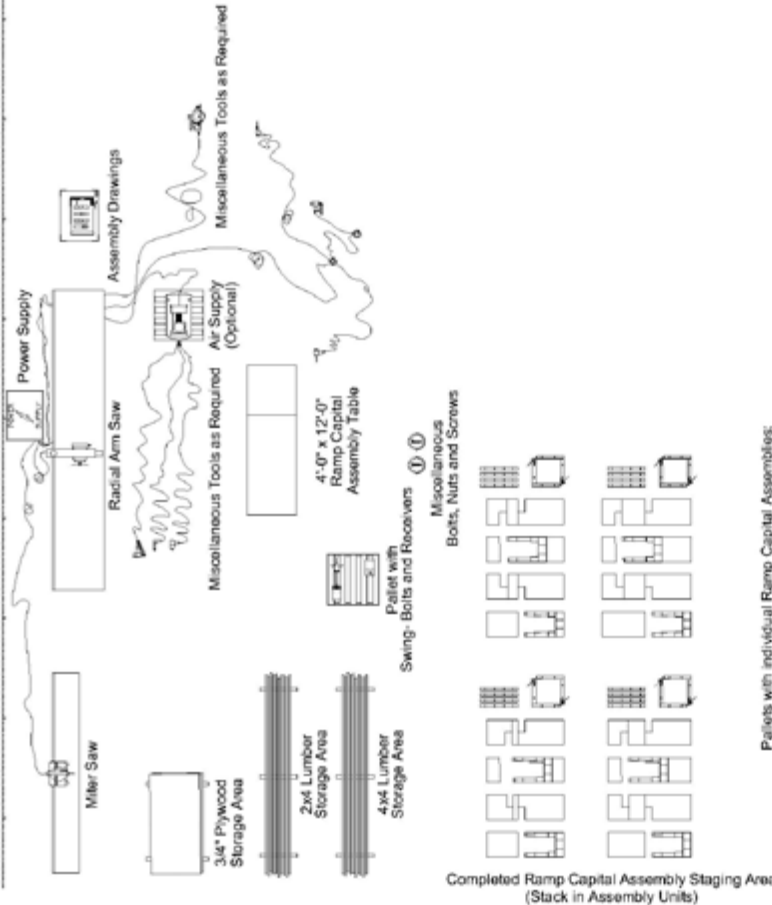

Completed Ramp Capital Assembly Staging Area  
(Stack in Assembly Units)

Pallets with individual Ramp Capital Assemblies:  
There should be a separate pallet for each of the Capital Assemblies required on the job (See the supplied Ramp Capital Assembly Drawings, RC-XX Series).

All of the parts that make up each of the Ramp Capital Assemblies should be included on that particular pallet, this includes: Friction Collar halves, Steel Capital Entry Panels, Capital Bolt-On Angles, All Fasteners and all of the Contractor-Built Lumber Panels.

The 2x4 Nailers should be pre-attached to the Entry Panels as required.  
Each Pallet should be neatly marked to clearly identify the individual Ramp Capital Assembly (See Page E-2 for additional information).

This may take some initial effort, but it is a great time-saver once it is complete.

## Capital and Ramp Capital Assembly Suggested Yard Layout

## GBS Capital Assembly Procedures

- A. The following Capital Assembly procedures will require one (1) carpenter, One (1) laborer and one (1) Forklift operator (when required), for a total of three (3) men.
- B. Before starting any Capital Assemblies:
- You should have all the Tools on the Beam Form Assembly and Deck Panel Assembly List (See pages C-1 and C-2).
  - There should be a designated Capital and Ramp Capital Assembly Staging and Build-Up Area (see page C-17).
  - You should have all the supplied Capital Assembly Drawings (C-xx Series Drawings).
1. Collect all Steel Capital components as they arrive on the Job Site and take them to a clean staging area. Keep all the same type Panels, Angles and Friction Collars together at first so that they can easily be identified and grabbed as they are needed.
  2. Once all the Panels, Angles, Friction Collars and Fit-Up Bolts are in the same area, start to break the components down into individual Capital Assemblies, using the supplied drawings for reference. This will typically be two (2) Entry Panels, two (2) Side Panels, two (2) Friction Collar halves, four (4) Angles and all the required Fit-Up Bolts for each Assembly. (Note that the GBS system has two different types of panels, Standard, Square Panels which require the use of an Angle on each side and Pin-Wheel Panels, which have one Square side and one Angles side built into each panel, these Pin-Wheel Panels do not require loose Angles).
  3. Add the 2x4 Nailers to the top of all the Panels, as required. Fit in the 3/4" Plywood Stressing Backs, with 2x4 blocking, to all back entries, as required. Miscellaneous fasteners are Contractor Supplied, See drawings for requirements.
  4. After all the components that are required to make one complete Capital Assembly are gathered together, take a new pallet and place all the items on it. Mark the pallet with the Capital Assembly number and place it over in a staging area.
  5. Continue this procedure for each of the required Capital Assemblies and the quantity required for each. Continue to move these completed Capital Assemblies to the staging area, keeping all like Assemblies in the same area so that they can easily be located, identified and taken for use as required and as quickly as possible. Remember, that as a Capital Assembly is stripped down, it is taken to the area of its next use and immediately put back up in place.

## GBS Ramp Capital Assembly Procedures

- A. The following Ramp Capital Assembly procedures will require two (2) carpenters, one (1) saw man, one (1) laborer and one (1) Forklift operator (when required), for a total of five (5) men.
- B. Before starting any Ramp Capital Assemblies:
- You should have all the Tools on the Beam Form Assembly and Deck Panel Assembly List (See pages C-1 and C-2).
  - There should be a designated Capital and Ramp Capital Assembly Staging and Build-Up Area (see page C-17).
  - You should have all the Ramp Capital Standard Drawings (RC-1. Series and RC-2. Series Drawings) and the supplied Ramp Capital Assembly Drawings (RC-xx Series Drawings).
1. Collect all Steel Capital components as they arrive on the Job Site and take them to a clean staging area (See Note 1).
  2. Once all the Panels, Angles, Friction Collars, Swing Bolts, Swing Bolt Receivers, 90 Degree Compression Corners and Fit-Up Bolts are in the same area, start to break the components down into individual Ramp Capital Assemblies, using the supplied drawings for reference. This will typically be two (2) Entry Panels, two (2) Friction Collar halves, four (4) Angles and all the required Fit-Up Bolts for each Assembly.
  3. Add the 2x4 Nailers to the top of the Entry Panels, as required. Miscellaneous fasteners are Contractor Supplied, See drawings for requirements.
  4. Using the supplied Ramp Capital drawings as reference, make all the required Lumber Panels as detailed on the drawings. (Note that the Side Panels are typically in Three (3) pieces). The over-all portions of these Lumber Panels are related to the required Ramp Capital Offset and should be carefully reviewed and verified by the Contractor.
  6. After all the Steel and Lumber components that are required to make one complete Ramp Capital Assembly are gathered together, clearly mark all of the pieces and place it over in a staging area. Continue until each Ramp Capital Assembly is complete. Often Ramp Capitals have different required offsets at different levels, so the Ramp Capitals will sometimes need to be modified or re-built to suit.

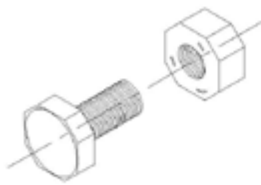

### Bolt Detail

Be sure that the notches on the Nut are facing the head of the Bolt before tightening

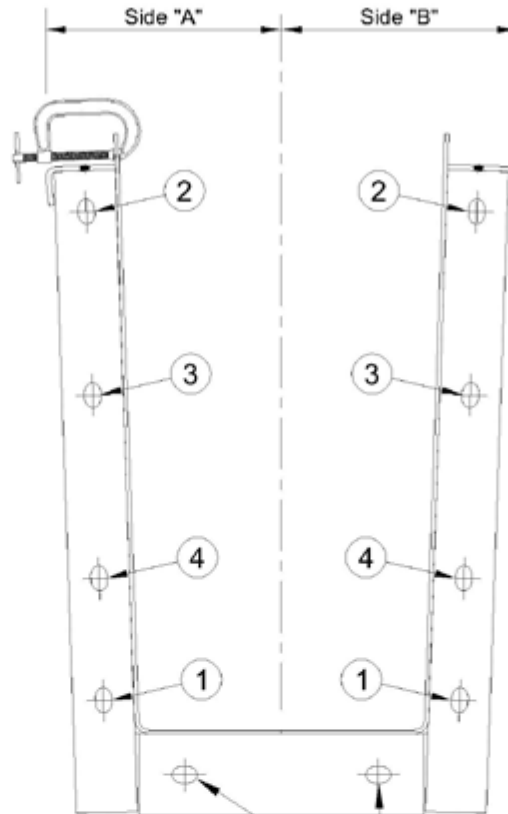

Do not put bolts in the two bottom slots until the entire beam form has been assembled and raised for frame attachment.

## Beam Bolt-Up Procedure

1. Align the soffit and the sides of the Beam Form and insert a Bolt in Slot 1 on side "A" as shown above. When skin is aligned, tighten with impact wrench.
2. Align and C-clip the top of skin plates together and insert a Bolt in Slot 2. Tighten with impact wrench.
3. Using a spud wrench, align Slot 3 and insert a Bolt in Slot 4. When the skin is aligned, use the impact wrench to tighten.
4. Insert a Bolt in Slot 3 and tighten with impact wrench.
5. When all four (4) Bolts on side "A" are in place and tightened, repeat procedure on side "B".

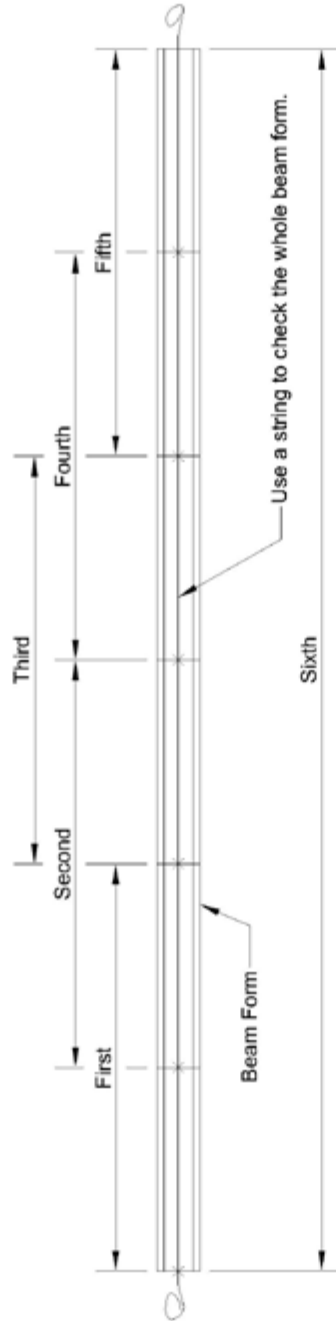

## Stringing the Beam Form

When checking the Beam Form assembly for straightness, never string more than two 10'-0" Beam Form sections at one time. Use the above order to string the Beam. When all sections are bolted in place, string the entire assembly. Find the center point and check for straightness. The assembly cannot be off by more than  $\frac{1}{4}$ " in 60'-0". If the assembly is off by more than  $\frac{1}{4}$ " in 60'-0", refer to page C-21 for straightening.

## Fixing a Dog Leg

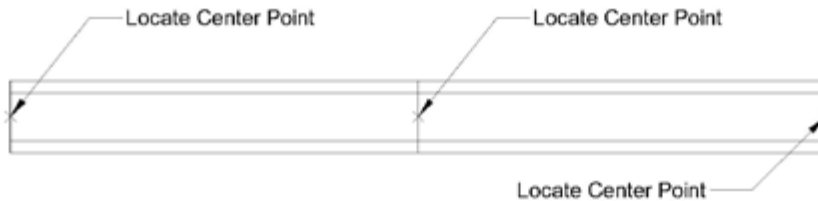

### Step One

Locate the center points of each Beam Form connection and mark each location.



### Step Two

Hold a string from point "A" to point "C" and pull it tight. Measure the distance between the string and point "B". This is the "dog leg" in the Beam Form. Divide the "dog leg" by  $\frac{1}{8}$ " and that will determine how many shims will be required to fix it.

Example: "dog leg" =  $\frac{1}{4}$ "  
 $\frac{1}{4} \div \frac{1}{8} = 2$   
 2 shims required



### Step Three

Unbolt the side of the Beam Form that the string was closest to. Install the shims and tighten the bolts hand tight. Flush the shims up with the inside of the Beam Form. Then, tighten the bolts with an impact wrench. Repeat as necessary.

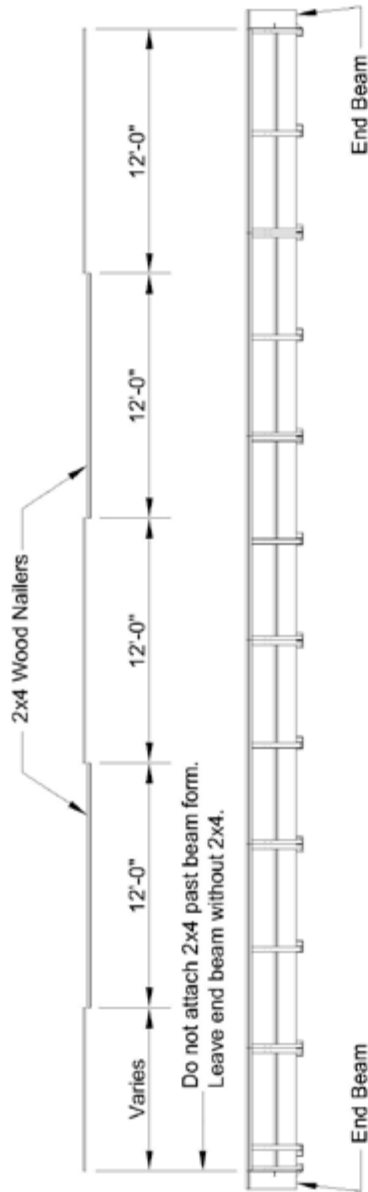

### Wood Nailer Assembly Procedure

1. Use 12'-0" 2x4's for the wood nailers.  
Use Douglas Fir No. 1 or better.
2. Stagger wood nailers so they never meet at a bolted connection along the Beam Form.
3. See next page for assembly procedures.

TOOLS, EQUIPMENT &  
ASSEMBLY DETAILS

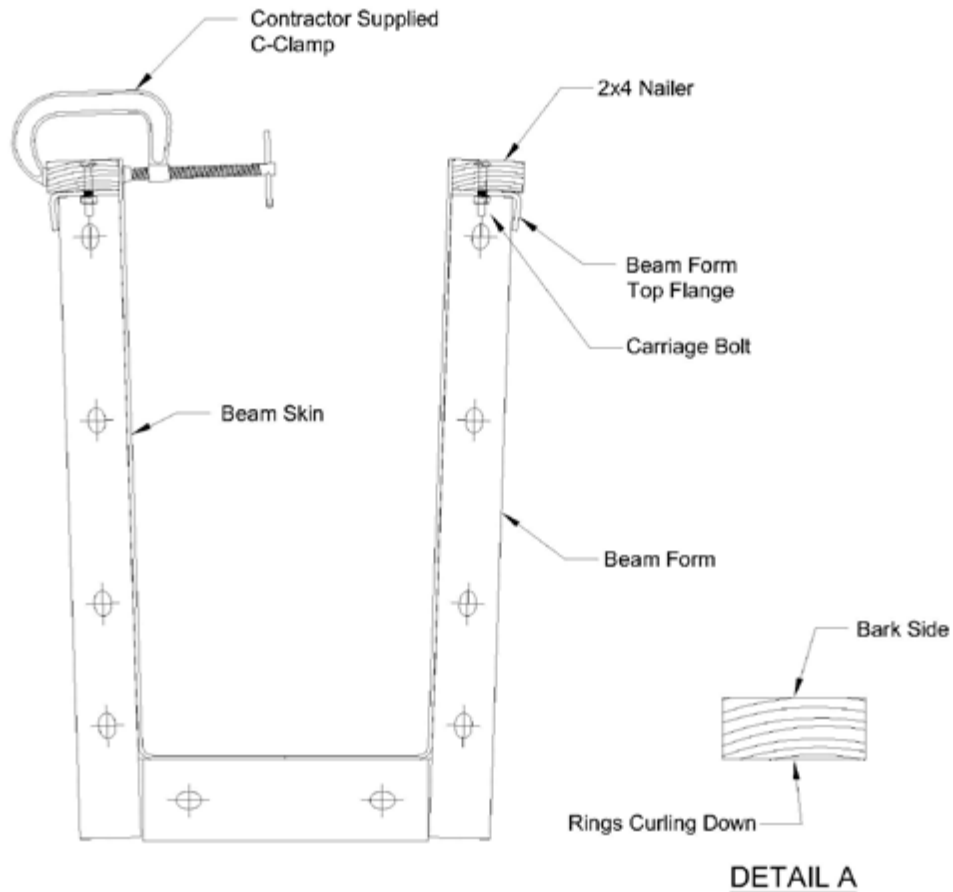

## Wood Nailer Attachment Procedure

1. Place 2x4 on top of the Beam Form (bark side up - see Detail "A"). Use Douglas Fir No. 1 or better.
2. Clamp the 2x4 Nailer tight to the Top Flange of the Beam Form. From the under-side of the Top Flange drill holes up through the 2x4. Keep the Drill Motor flat against Beam Form Skin, allowing the hole to be drilled on a slight angle outward (to match the Beam draft), that way, when the Bolt is placed and tightened, it will pull the 2x4 tighter to the Beam Skin.
3. Drive the Carriage Bolts down into the 2x4 until the square shoulder of the Bolt has set.
4. Ratchet the Nut or use an Electric Impact Wrench until the crown of the head is flush with the top of the 2x4.

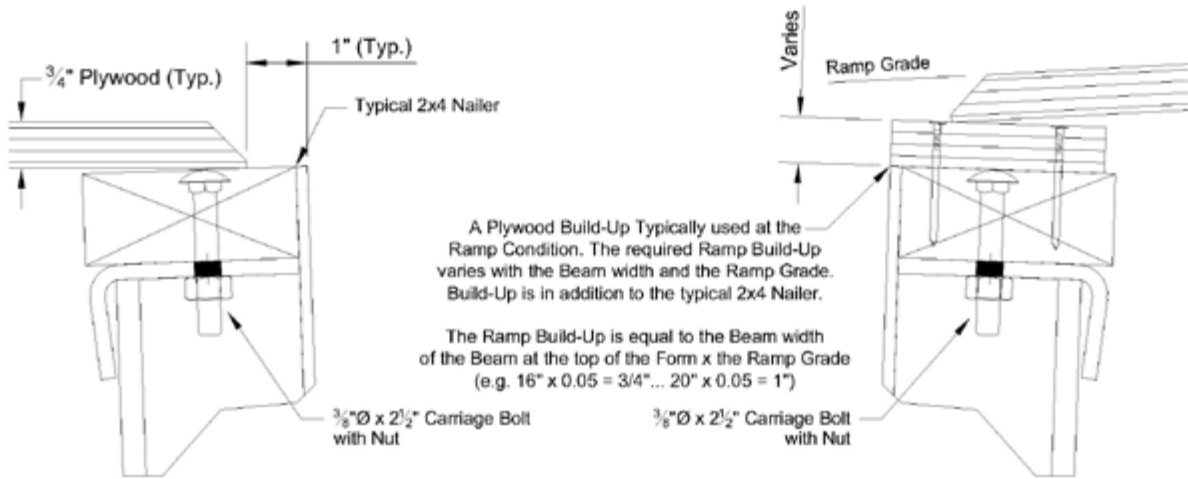

Standard 2x4 Nailer with No Build-Up

Standard 2x4 Nailer with Plywood Build-Up at Ramp

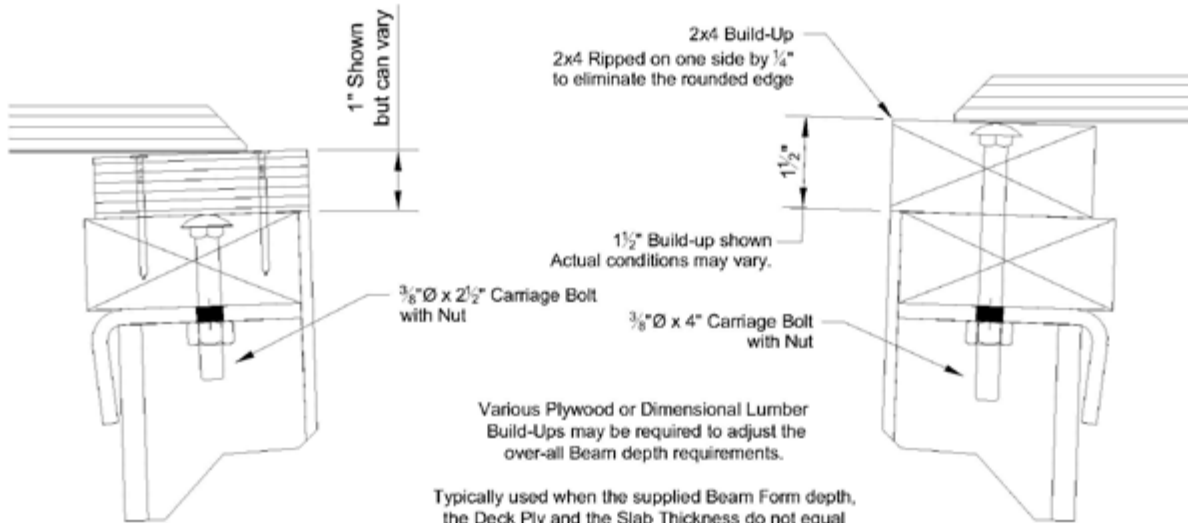

Plywood Build-Up for Depth Adjustment

2x4 Lumber Build-Up

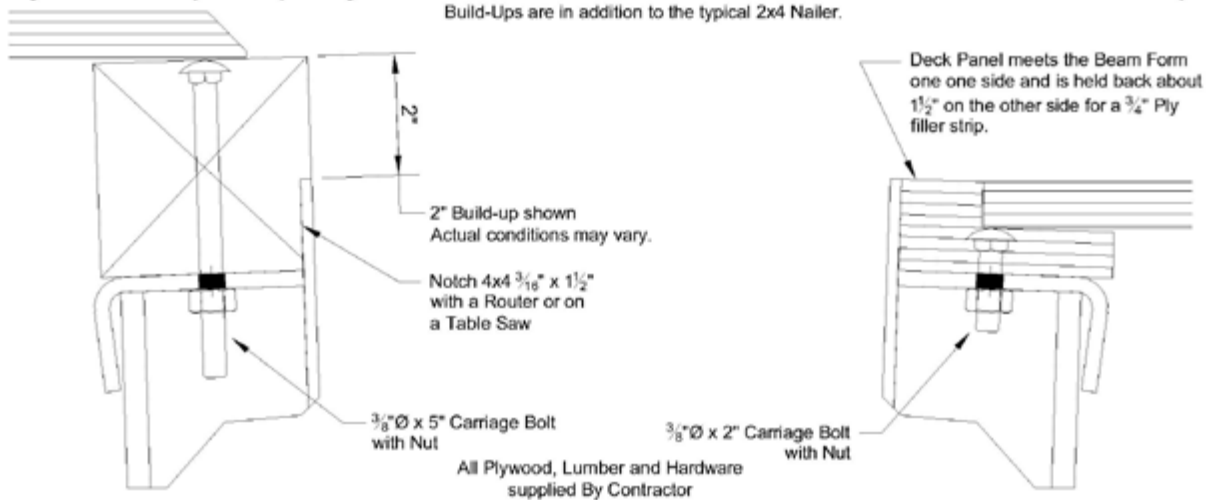

Dimensional Lumber Build-Up

Recessed Deck

## Beam Form Build-Up Details

TOOLS, EQUIPMENT & ASSEMBLY DETAILS



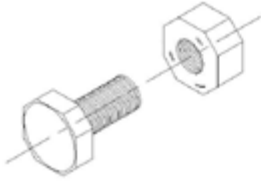

### Bolt Detail

Be sure that the notches on the Nut are facing the head of the Bolt before tightening

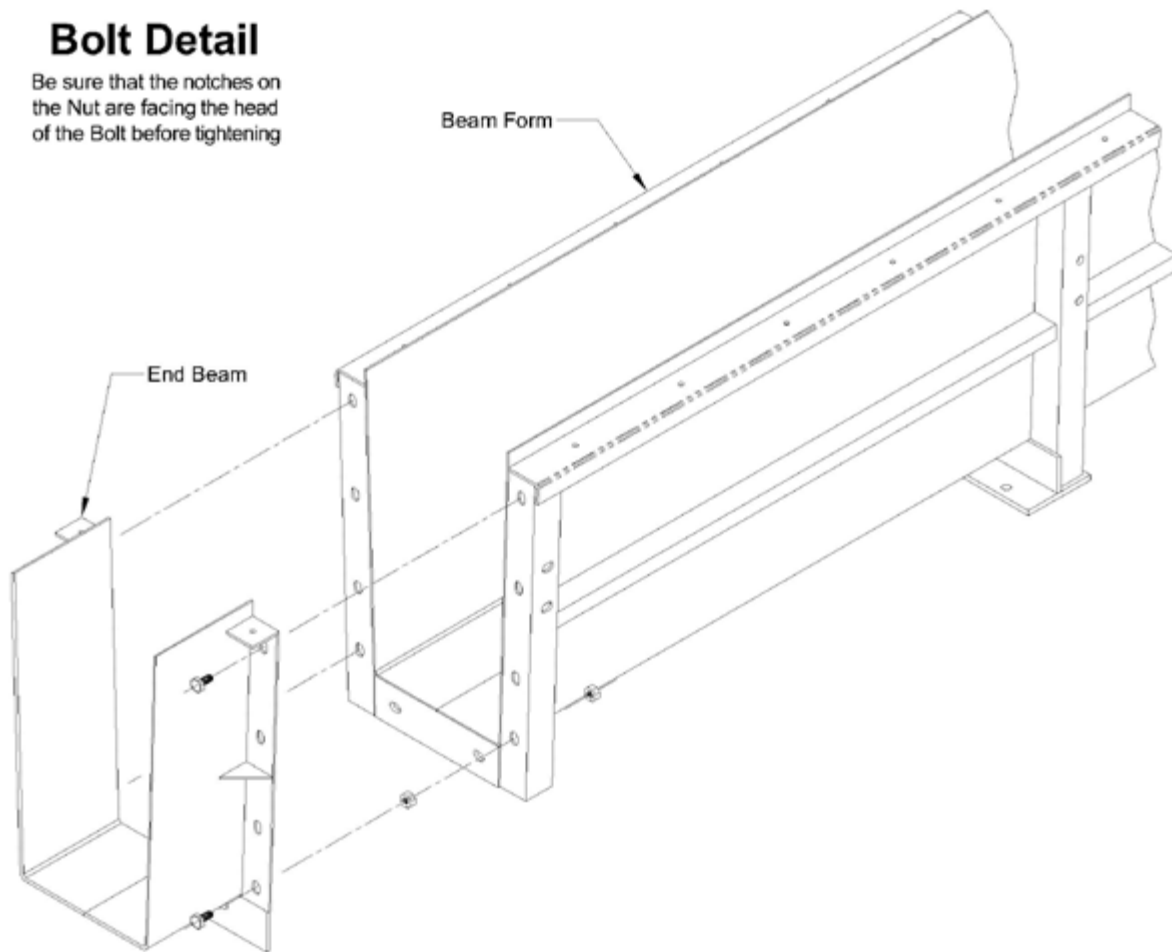

### End Beam Bolt-Up Procedure

When bolting on the end beam, it is only necessary to use six bolts. Align the end beam skin with the beam form skin and bolt in place. Check for straightness and impact all four bolts tight.

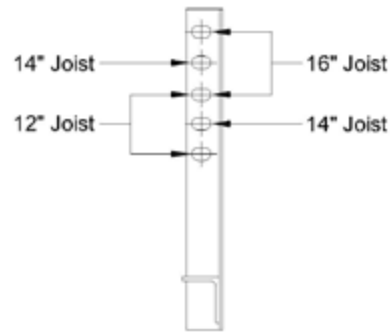

DETAIL "A": Slot Usage

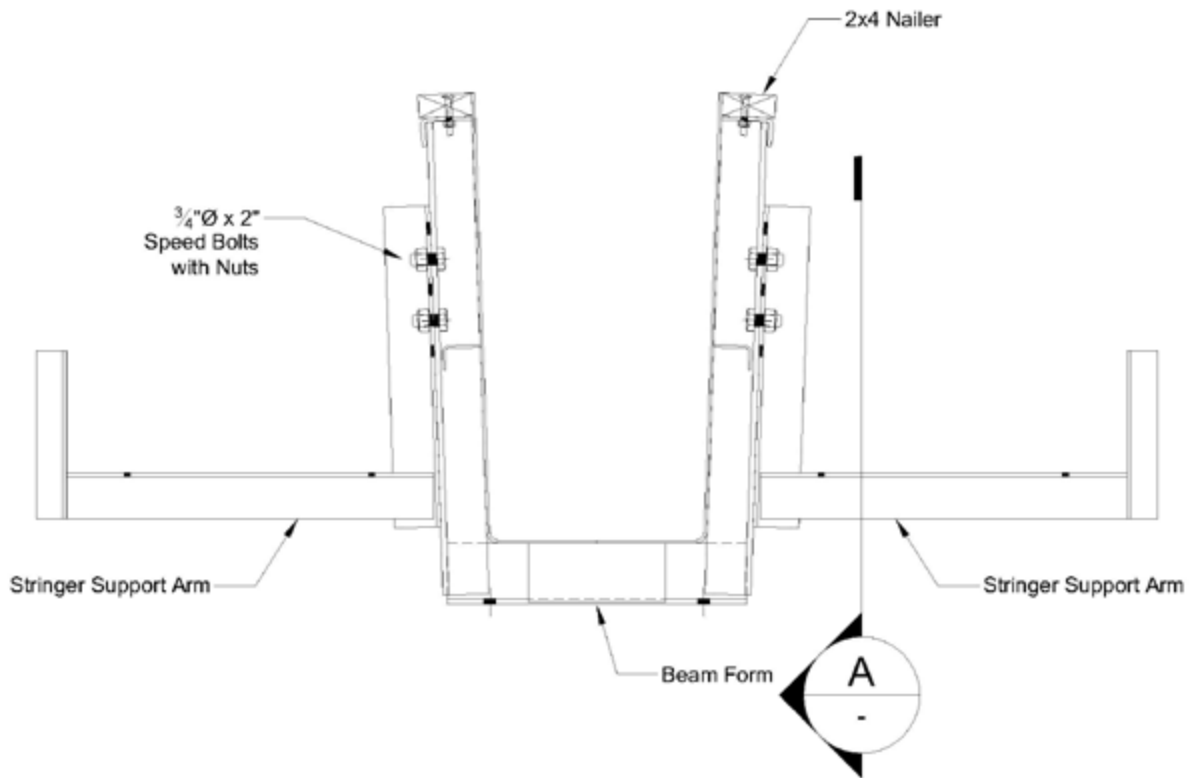

TOOLS, EQUIPMENT & ASSEMBLY DETAILS

## Stringer Support Arm Attachment

Bolt on the Stringer Support Arms at locations shown on individual Beam Elevations.

**Stripping Saddle Quantity Requirements**  
**Typical Beam Assembly - 2 Required**  
**Typical Transfer Girder Assembly - 4 Required (Minimum)**  
**See Individual Job Beam Elevation Drawings**  
**for Quantities and Attachment Locations**

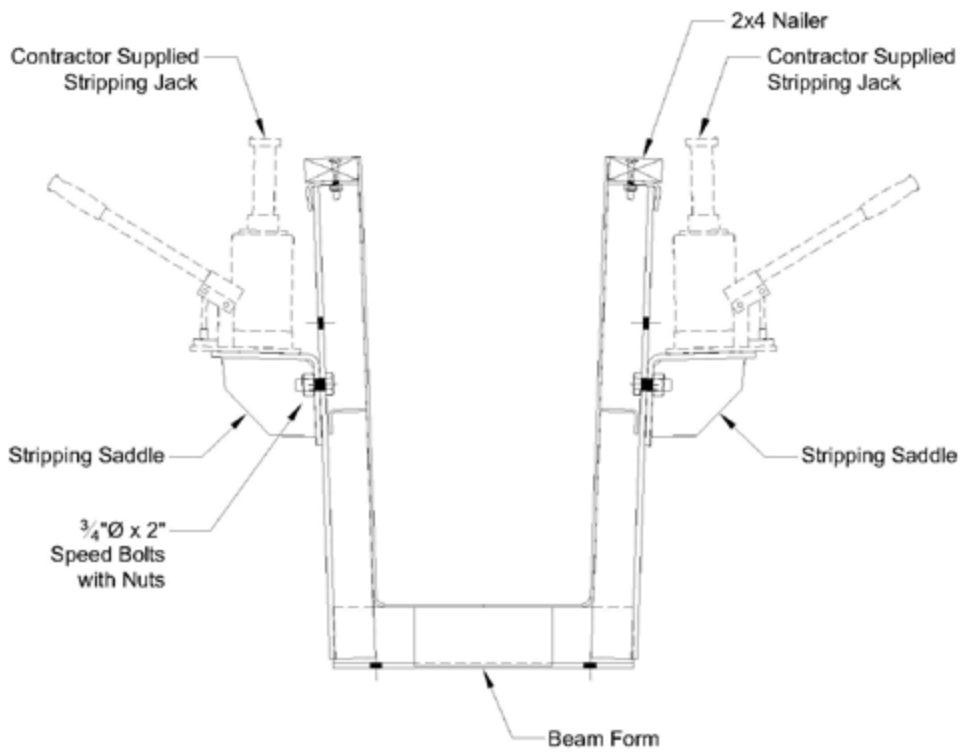

**Stripping Saddle Attachment**

Be certain that the top of the Stripping Saddle is parallel to the bottom of the Beam Form when installing. If the Stripping Saddle is not installed properly, the Stripping Jack will not seat properly and may cause the Jack to blow out.

Adjust the height of the Stripping Saddle to accommodate the Stripping Jack. Hand tighten in place. Check for straightness and tighten with an impact wrench when it has been adjusted.

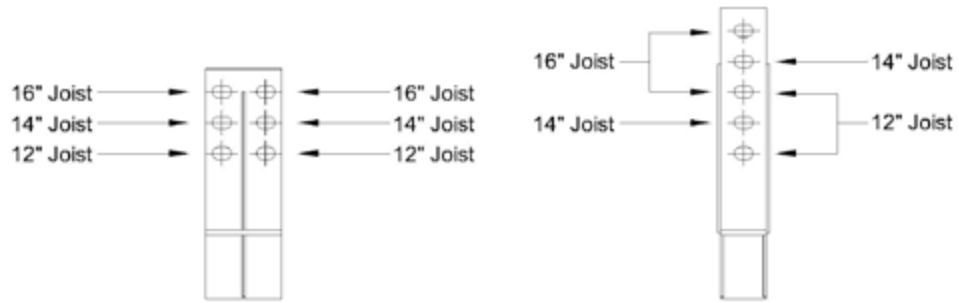

**DETAIL "A": Slot Usage**  
**Double Rib Bracket**

**DETAIL "A": Slot Usage**  
**Single Rib Bracket**

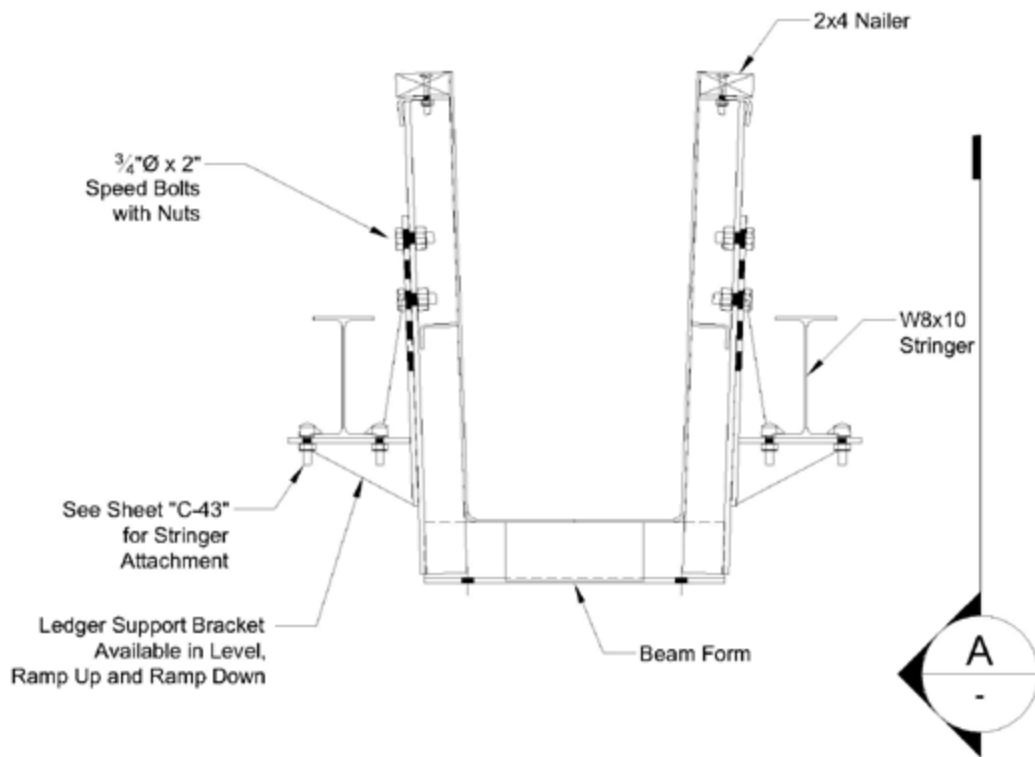

TOOLS, EQUIPMENT &  
ASSEMBLY DETAILS

## Ledger Support Bracket Attachment

Bolt on the Ledger Brackets at locations shown on individual Beam Elevations.

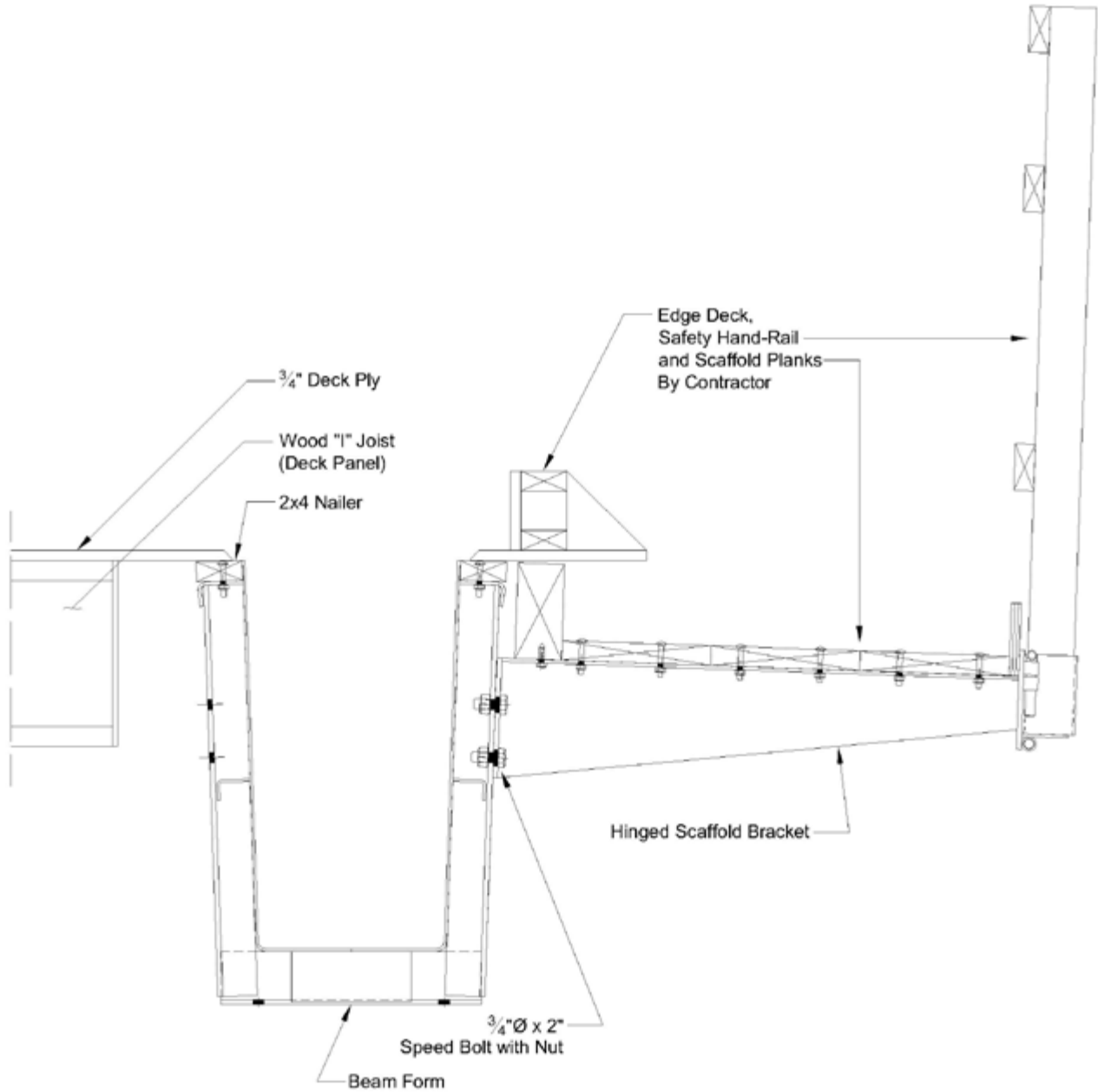

## Hinged Scaffold Bracket Attachment

Bolt the Hinged Scaffold Brackets at locations shown on individual Beam Elevations.

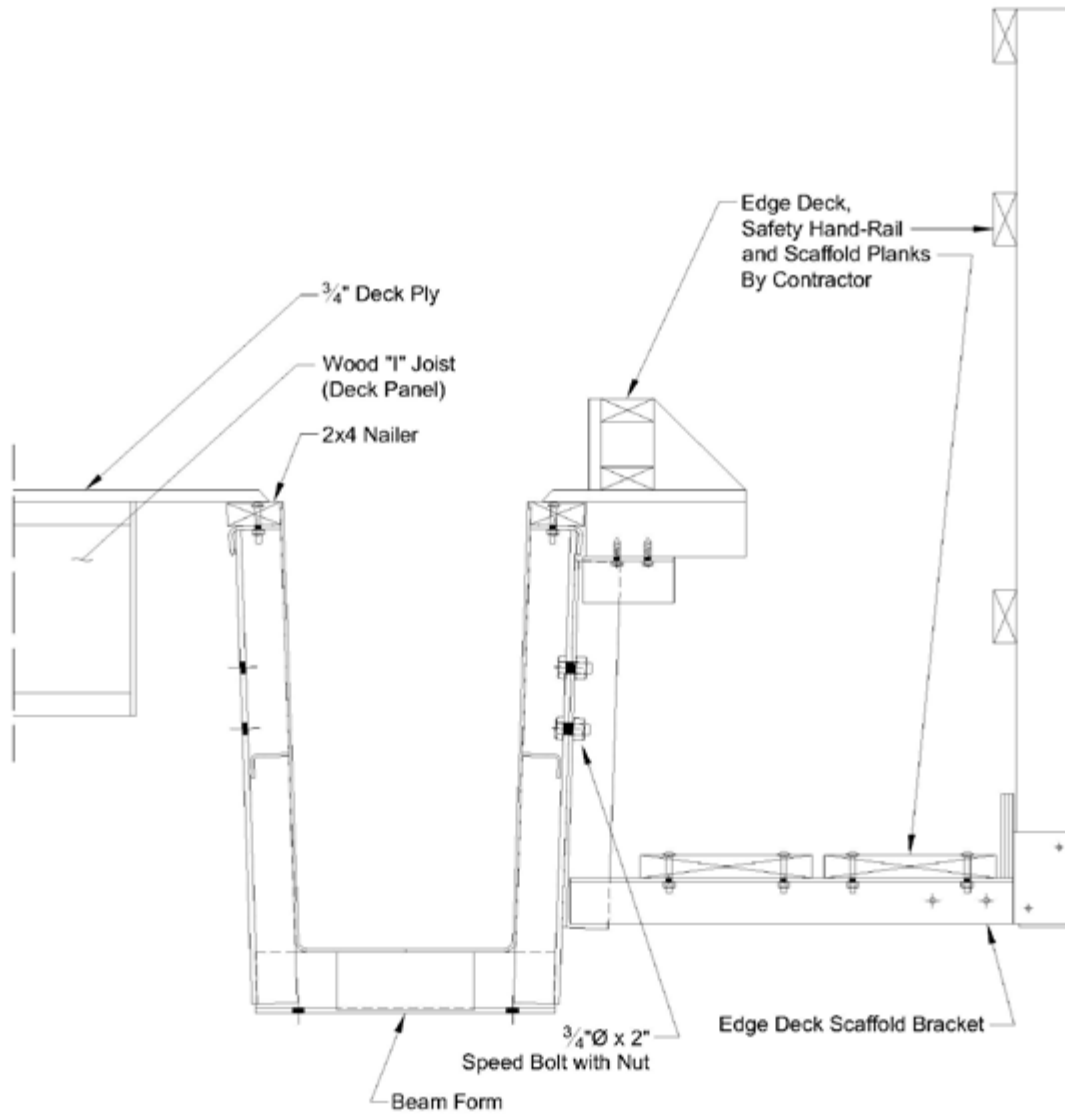

TOOLS, EQUIPMENT & ASSEMBLY DETAILS

## Edge Deck Scaffold Bracket Attachment

Bolt the Edge Deck Scaffold Brackets at locations shown on individual Beam Elevations.

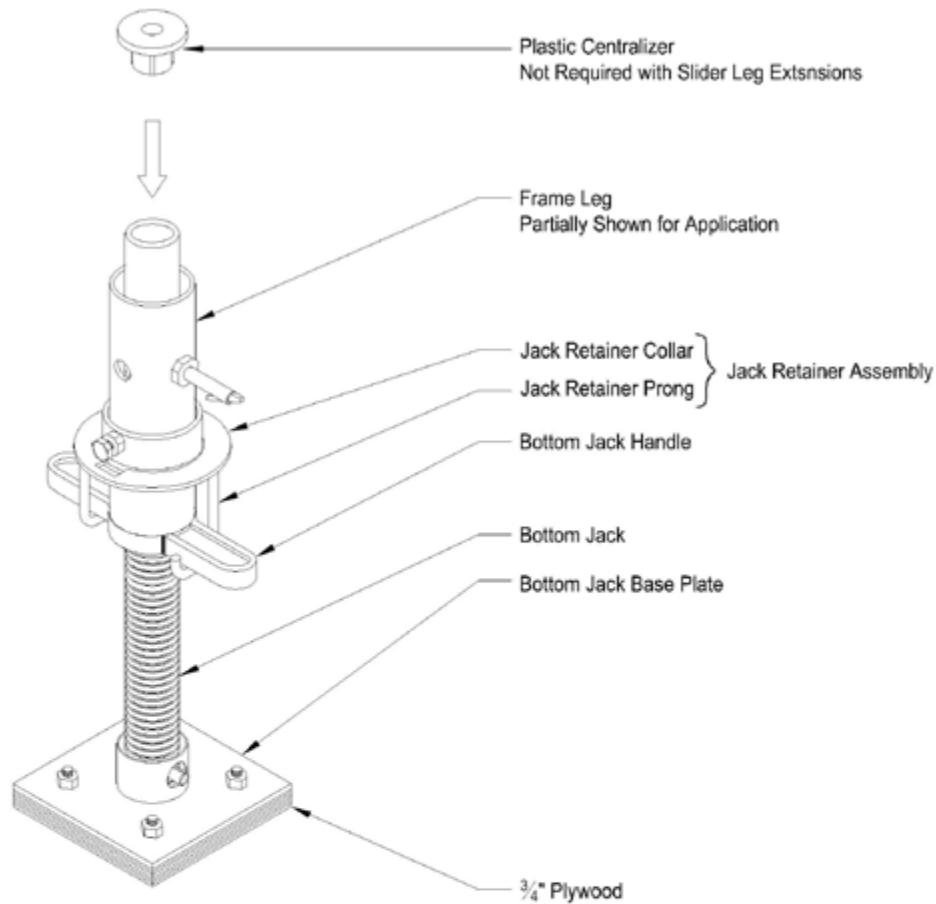

**Note:**  
Place a 4x6 under the Bottom End of the Frame so it can be Elevated off of the Ground to slide the Jack Retainers and Bottom Jacks on during Build-Up.

## Bottom Jack and Jack Retainer Assembly

1. Before mounting the Bottom Jack and Retainer on the Frame, be sure that the Bottom Jack has a piece of plywood already bolted to the base plate and a centralizer into the top of the Bottom Jack. (No Centralizer required when used with a Slider Leg Extension).
2. Put the Jack Retainer on the Frame Leg with the hooks pointing toward the bottom of the Frame.
3. Place the Retaining Collar on the Frame Leg loosely.
4. Insert the Bottom Jack into the Frame Leg. Be sure to let the hooks on the Jack Retainer wrap around the Jack Handle.
5. Adjust the Retaining Collar so that the Jack Handle can move easily, then tighten the Retaining Collar screw.

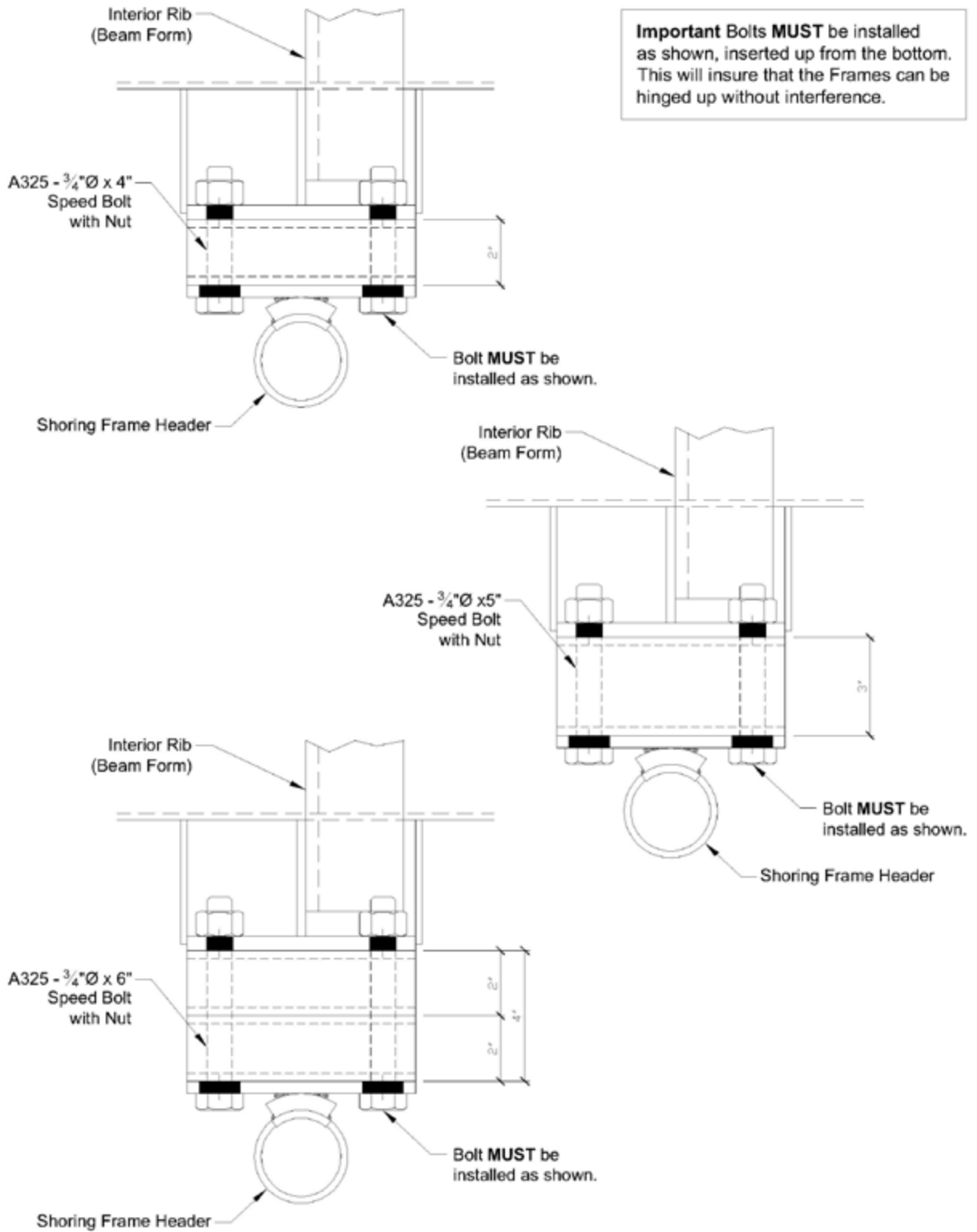

TOOLS, EQUIPMENT & ASSEMBLY DETAILS

## Beam Form to Garage Frame with Spacers Bolt-Up Details



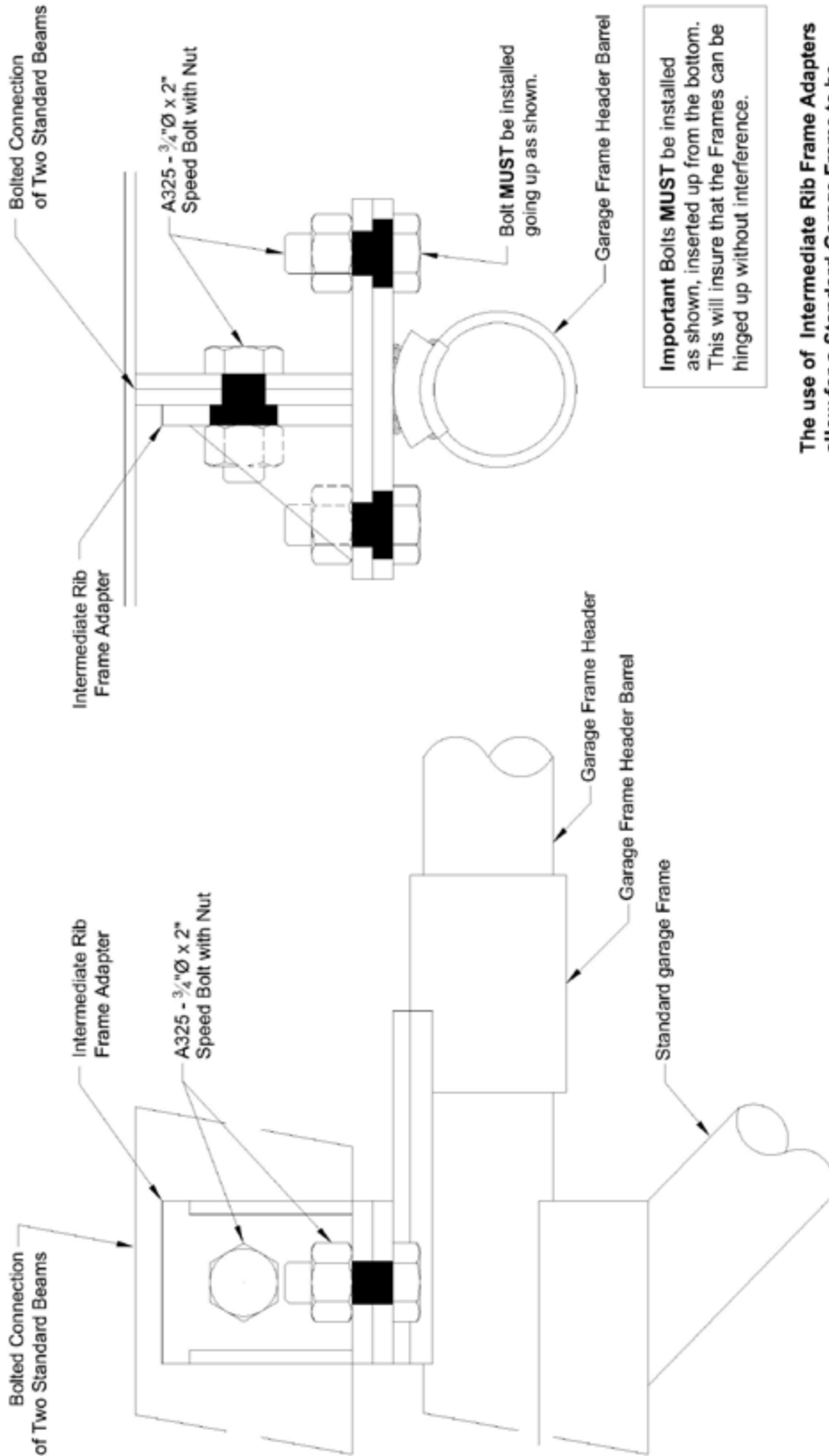

**Important Bolts MUST** be installed as shown, inserted up from the bottom. This will insure that the Frames can be hinged up without interference.

The use of **Intermediate Rib Frame Adapters** allow for a **Standard Garage Frame** to be used at a **Beam Bolted Connection** rather than at the **standard Interior Rib position**.

This is a **situational condition** and only used when necessary.

## Intermediate Rib Frame Adapter Bolt-Up Detail

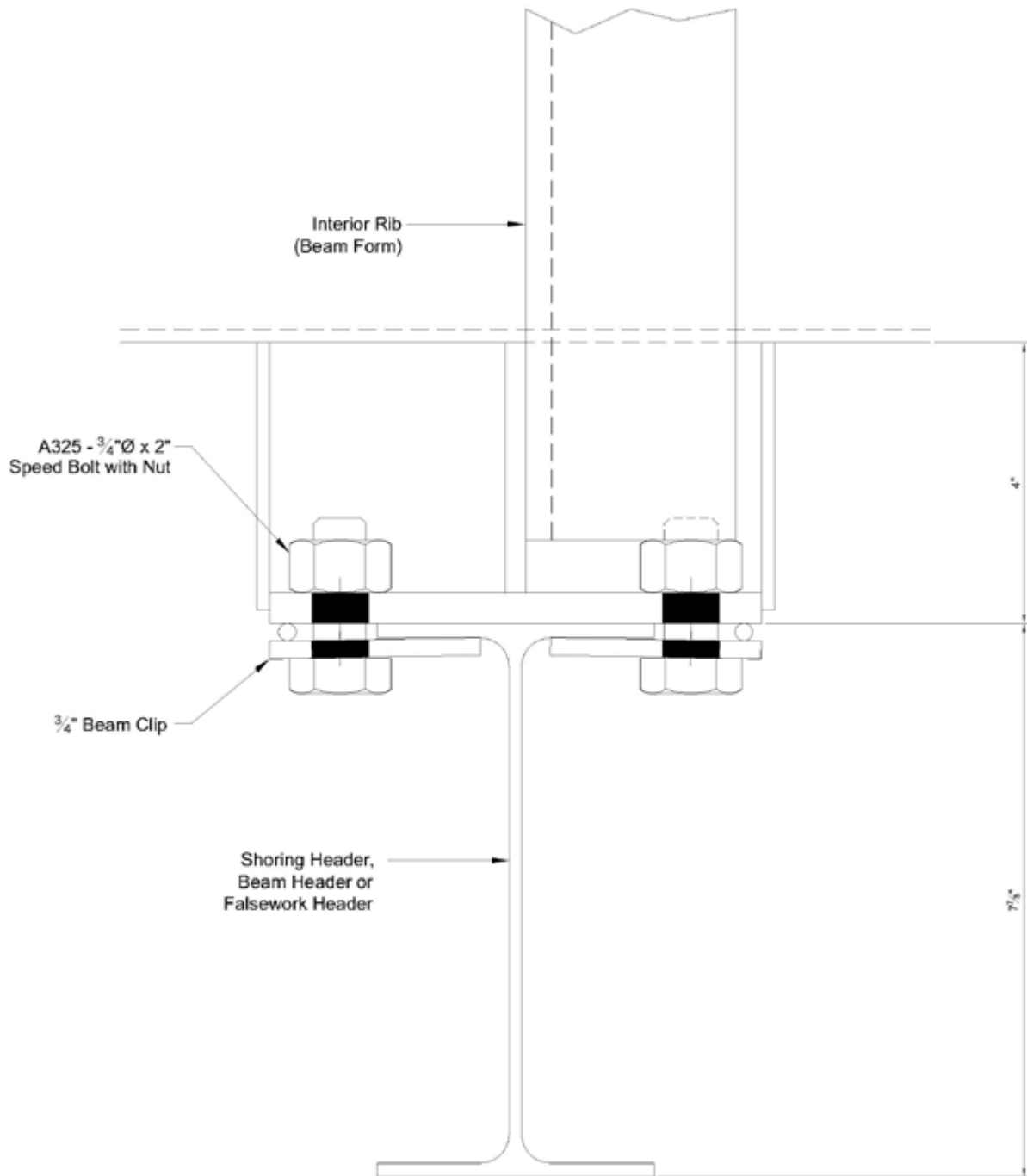

TOOLS, EQUIPMENT & ASSEMBLY DETAILS

### Beam Form to Header Bolt-Up Detail

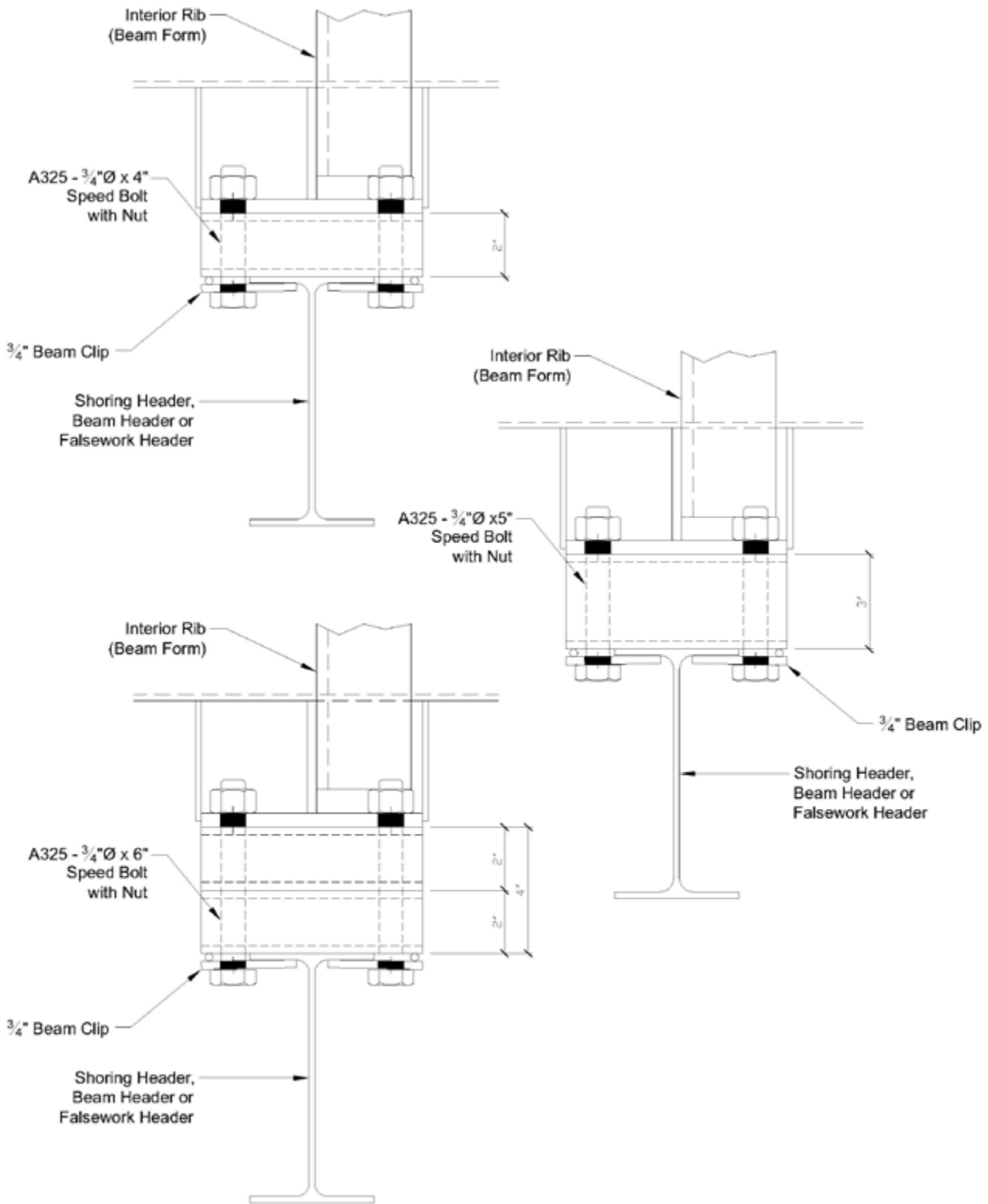

### Beam Form to Header with Spacers Bolt-Up Details

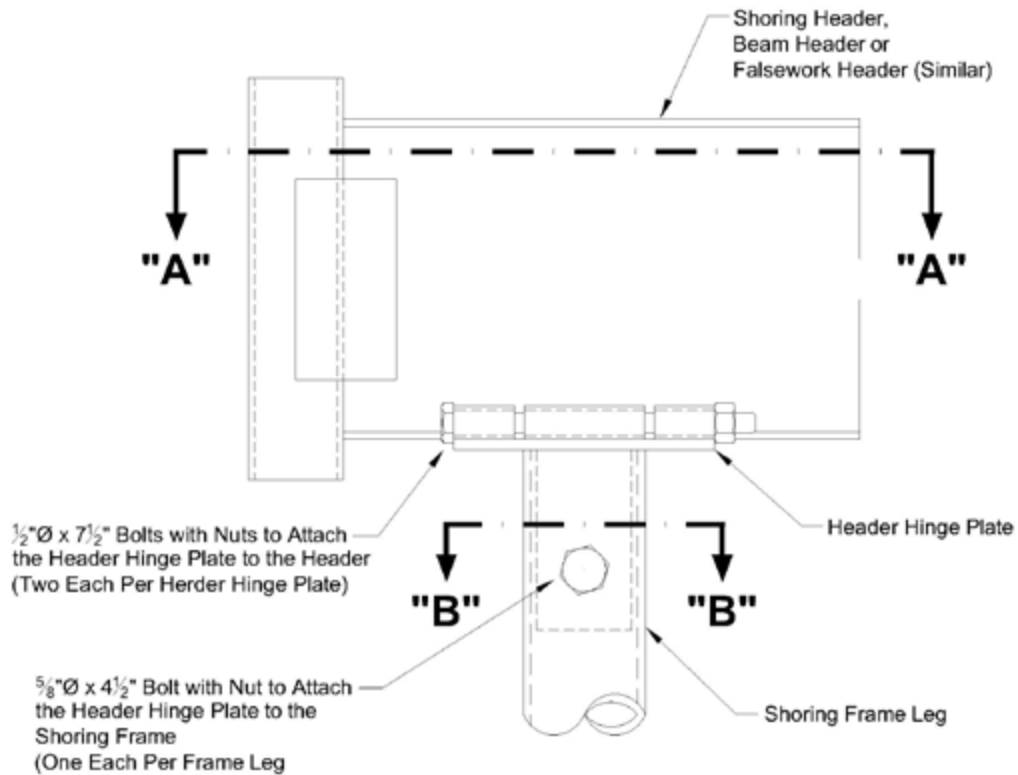
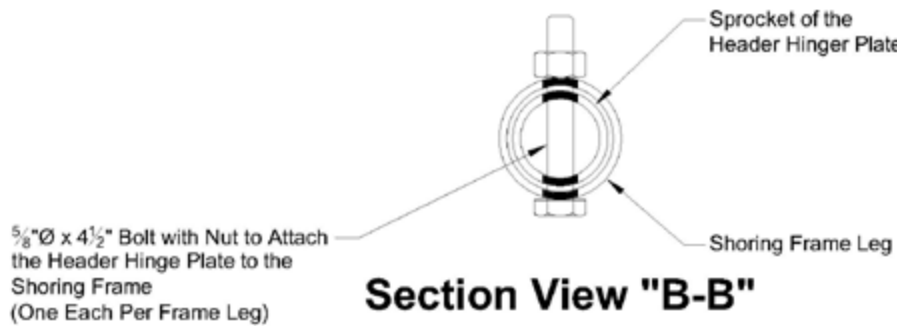
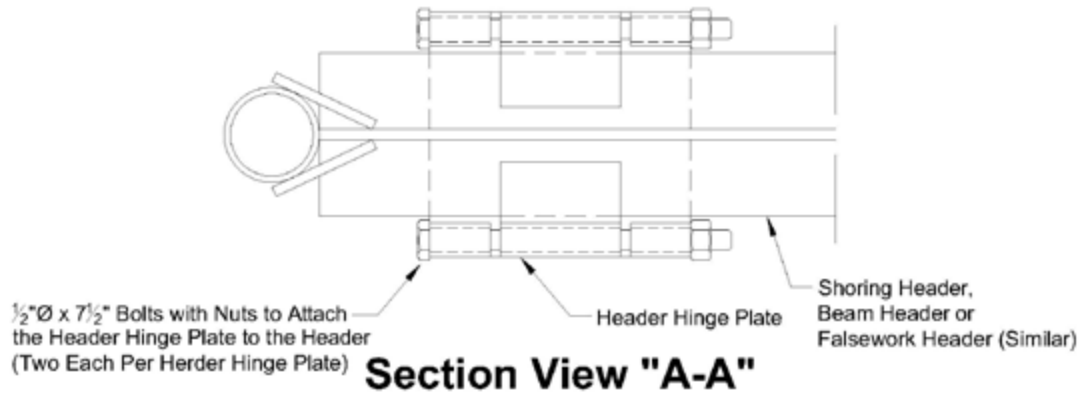

## Header Hinge Plate Attachment to the Header and to the Shoring Frame

TOOLS, EQUIPMENT & ASSEMBLY DETAILS

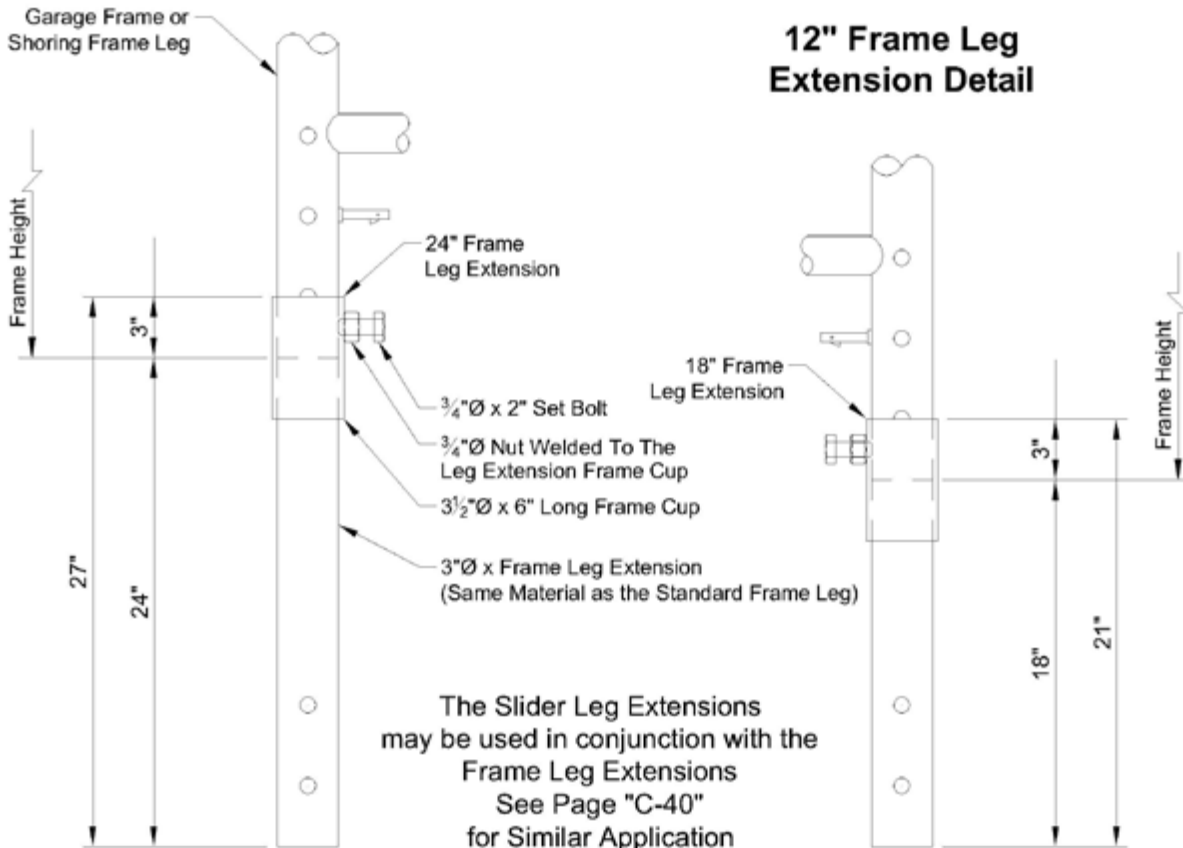
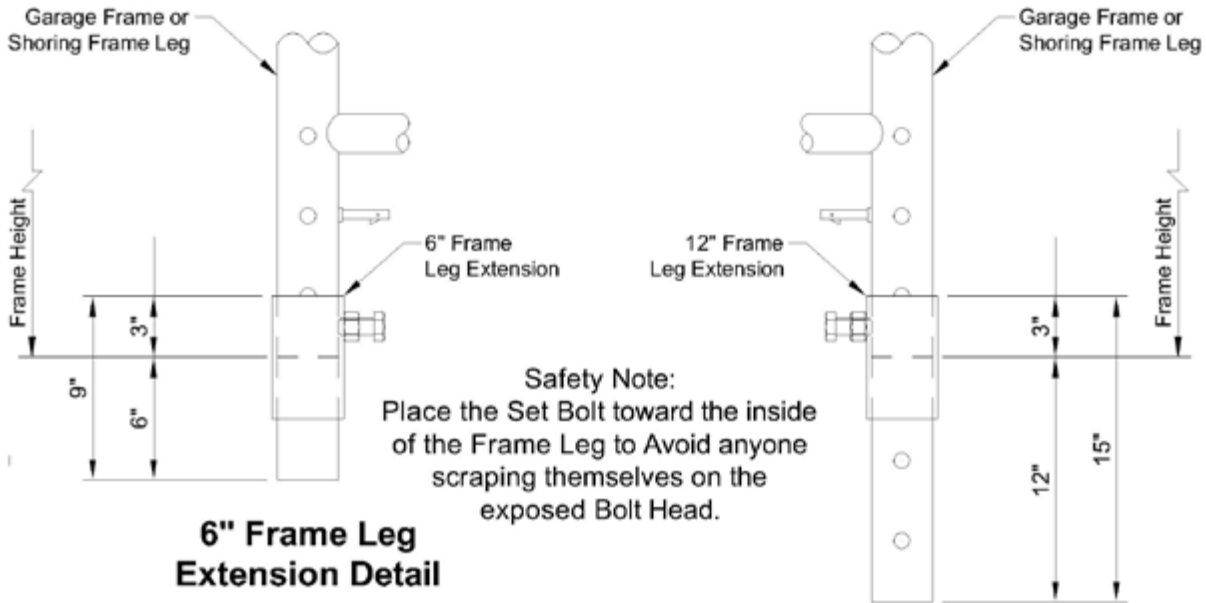

**6", 12", 18" and 24" Frame Leg Extensions**

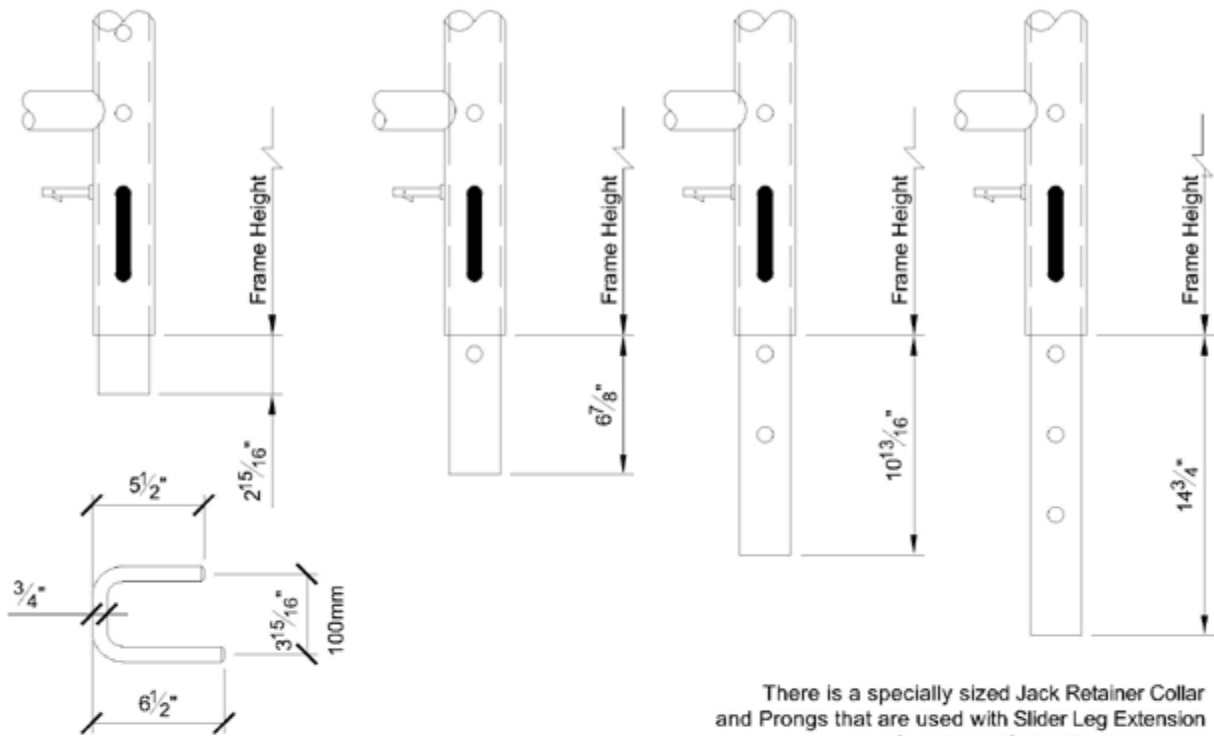

There is a specially sized Jack Retainer Collar and Prongs that are used with Slider Leg Extension See Page "C-41" For Application

The Slider Leg Extensions may be used in conjunction with the Frame Leg Extensions See Page "C-39" for Similar Application

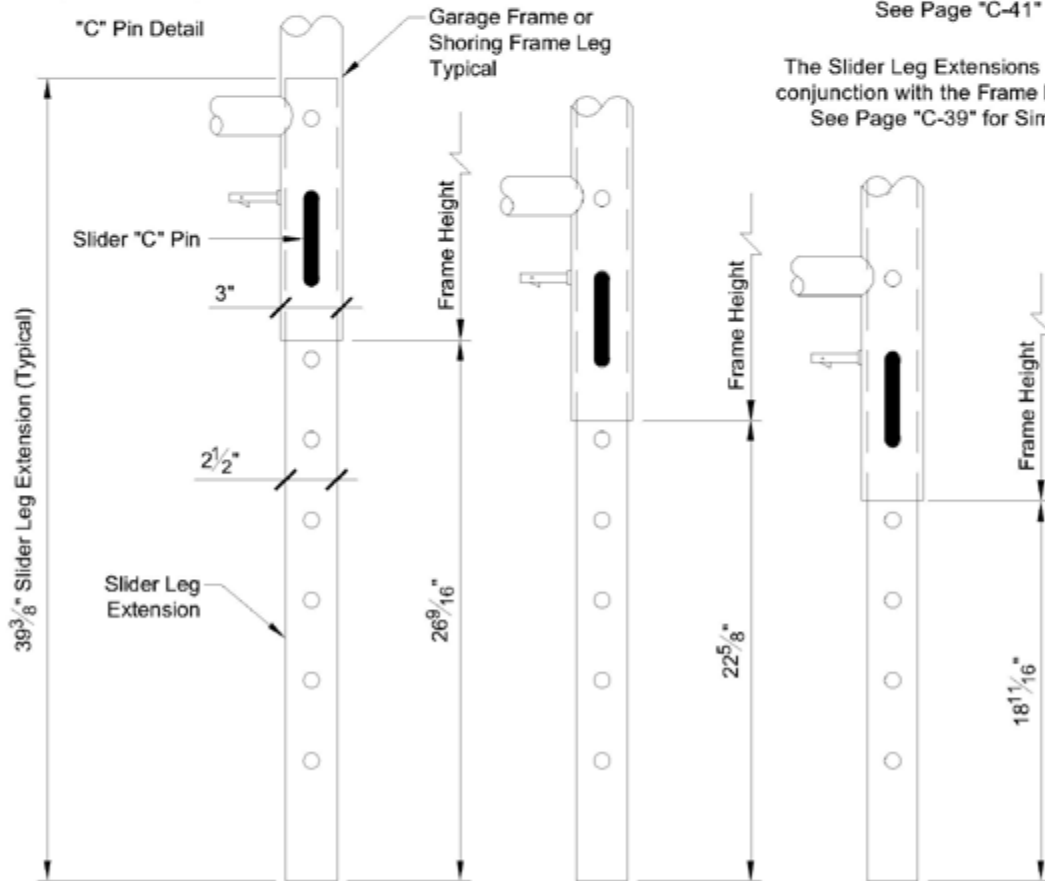

## Adjustable Slider Leg Extensions Installation and Range

TOOLS, EQUIPMENT & ASSEMBLY DETAILS

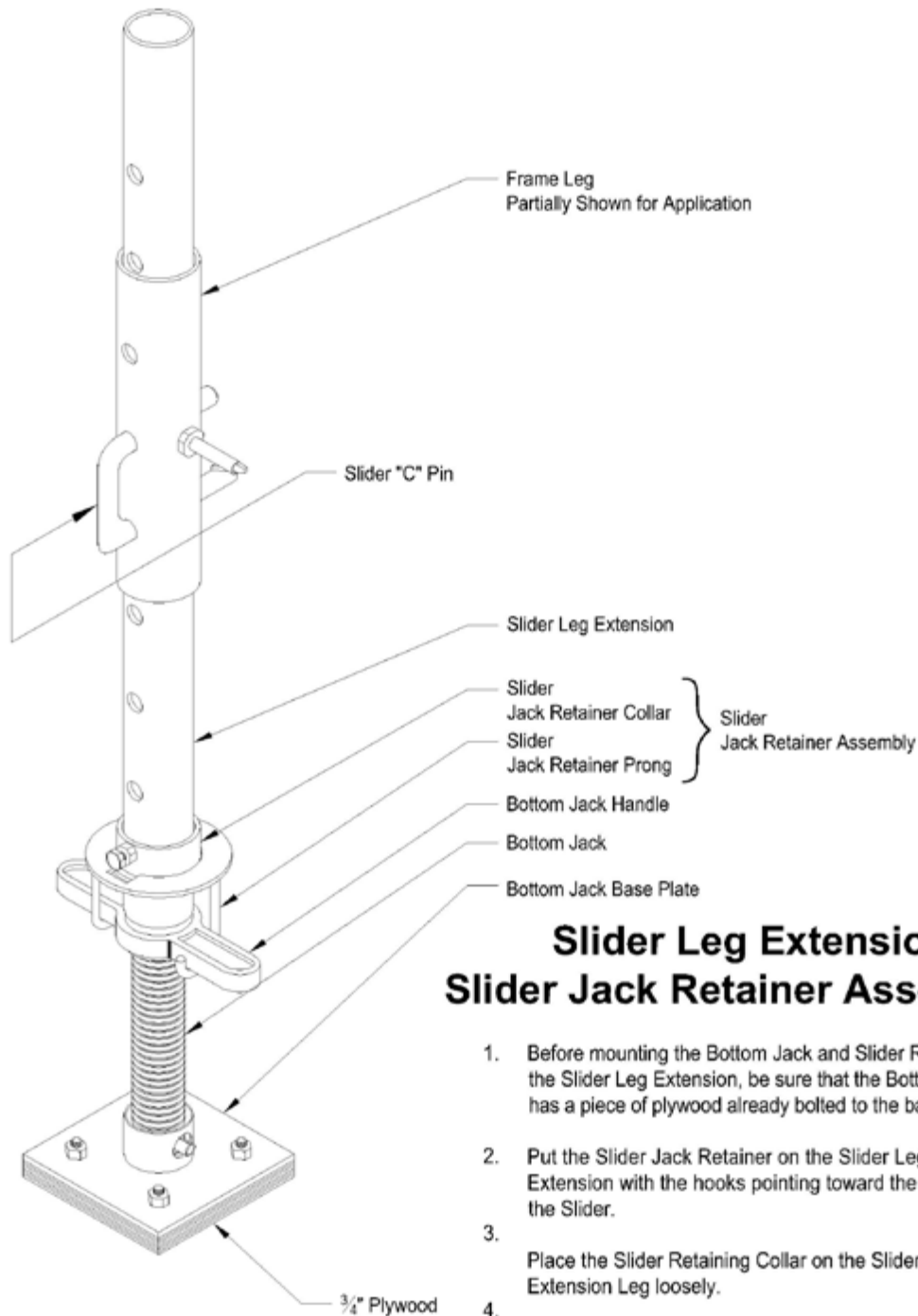

## Slider Leg Extension and Slider Jack Retainer Assembly

1. Before mounting the Bottom Jack and Slider Retainer on the Slider Leg Extension, be sure that the Bottom Jack has a piece of plywood already bolted to the base plate.
2. Put the Slider Jack Retainer on the Slider Leg Extension with the hooks pointing toward the bottom of the Slider.
3. Place the Slider Retaining Collar on the Slider Leg Extension Leg loosely.
4. Insert the Bottom Jack into the Slider Leg Extension. Be sure to let the hooks on the Slider Jack Retainer wrap around the Jack Handle.
5. Adjust the Retaining Collar so that the Jack Handle can move easily, then tighten the Retaining Collar screw.

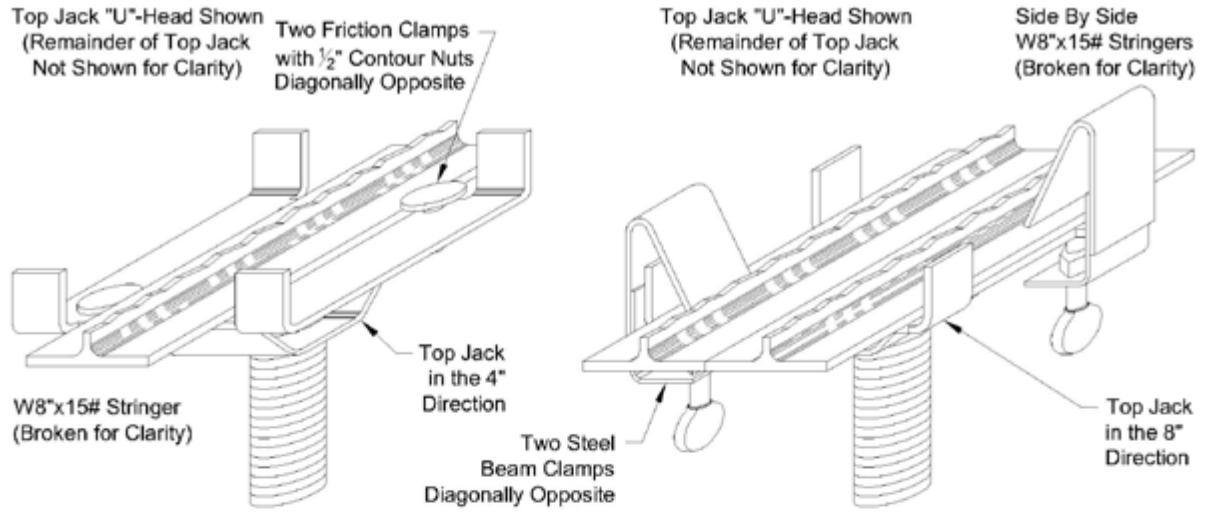

**(Single Stringer Attachment Detail) (Double Stringer Attachment Detail)**

Important Safety Note: All Stringers Must Be Securely Clamped to the Top Jack "U"-Head when in Setting, when In Use, when Stripping and when Transporting the Beam Forms. However, the clamps may be loosened up to slide the Stringers into their proper position along the Beam length and then re-tighten the Clamps as soon as the Stringers are in position.

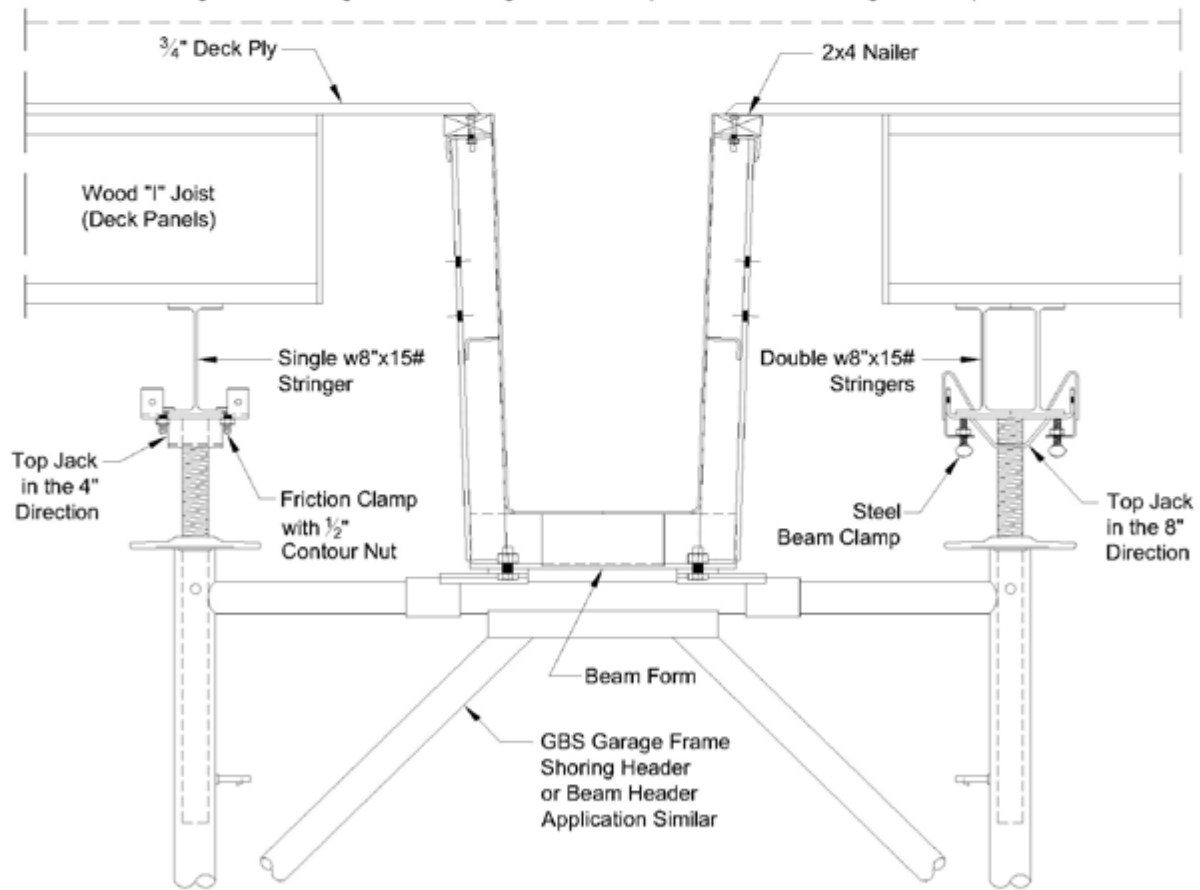

**W8\"/>**

TOOLS, EQUIPMENT &  
ASSEMBLY DETAILS



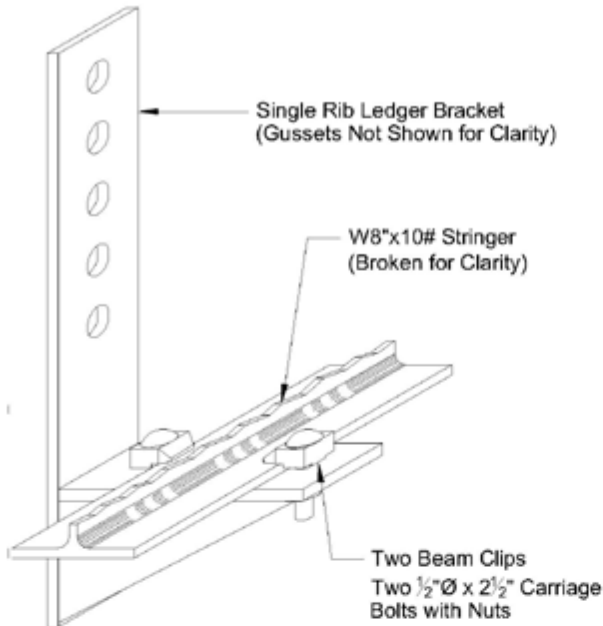

**(Single Rib Bracket Detail)**

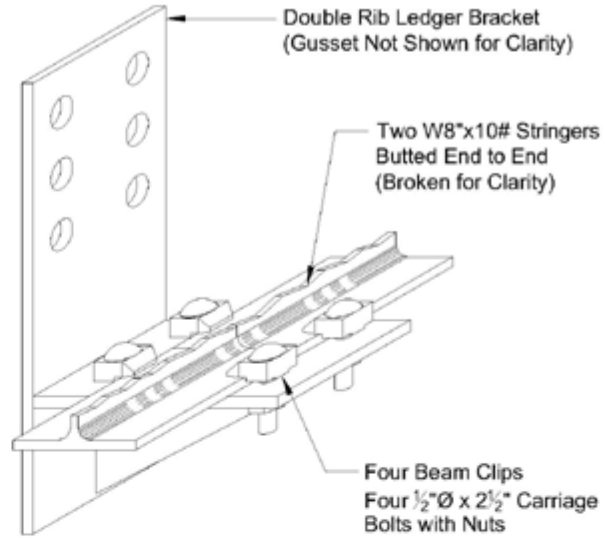

**(Double Rib Bracket Detail)**

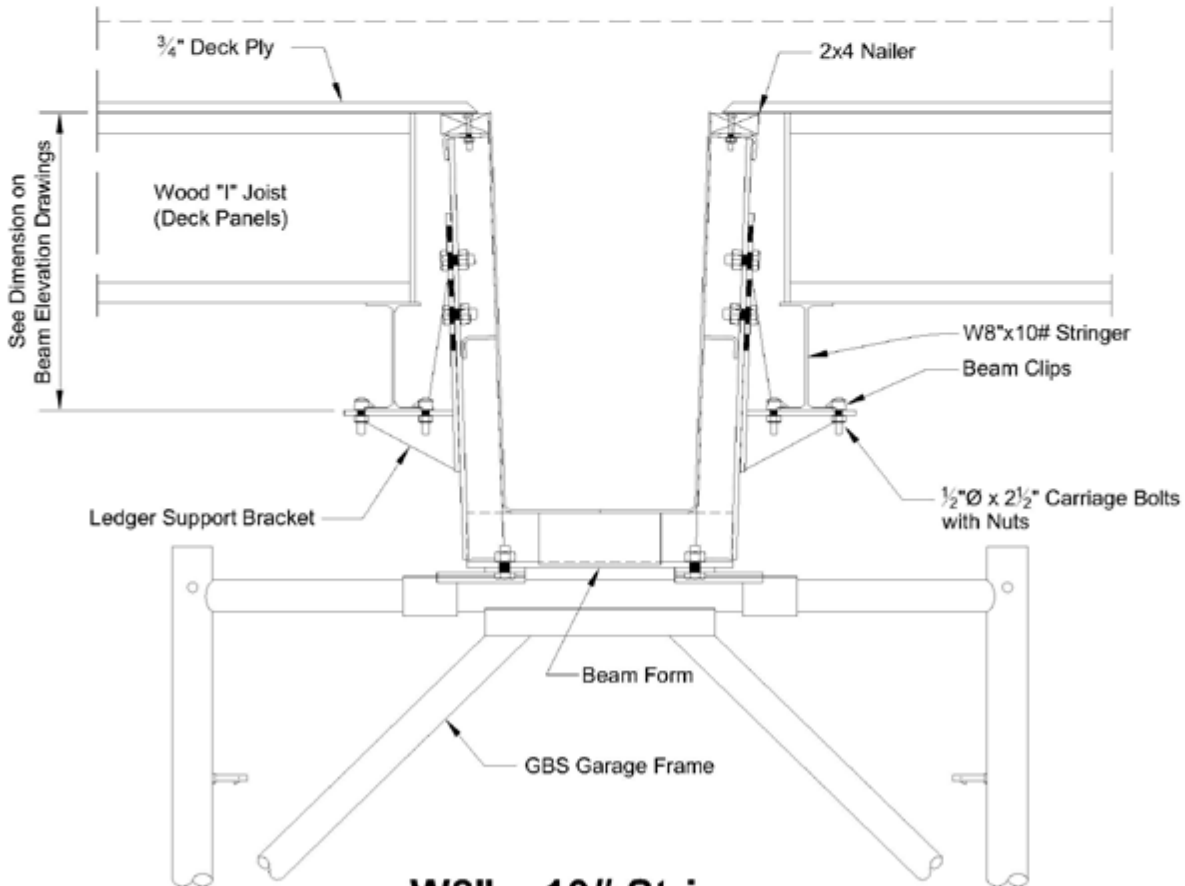

**W8" x 10# Stringer  
to Ledger Bracket Attachment**

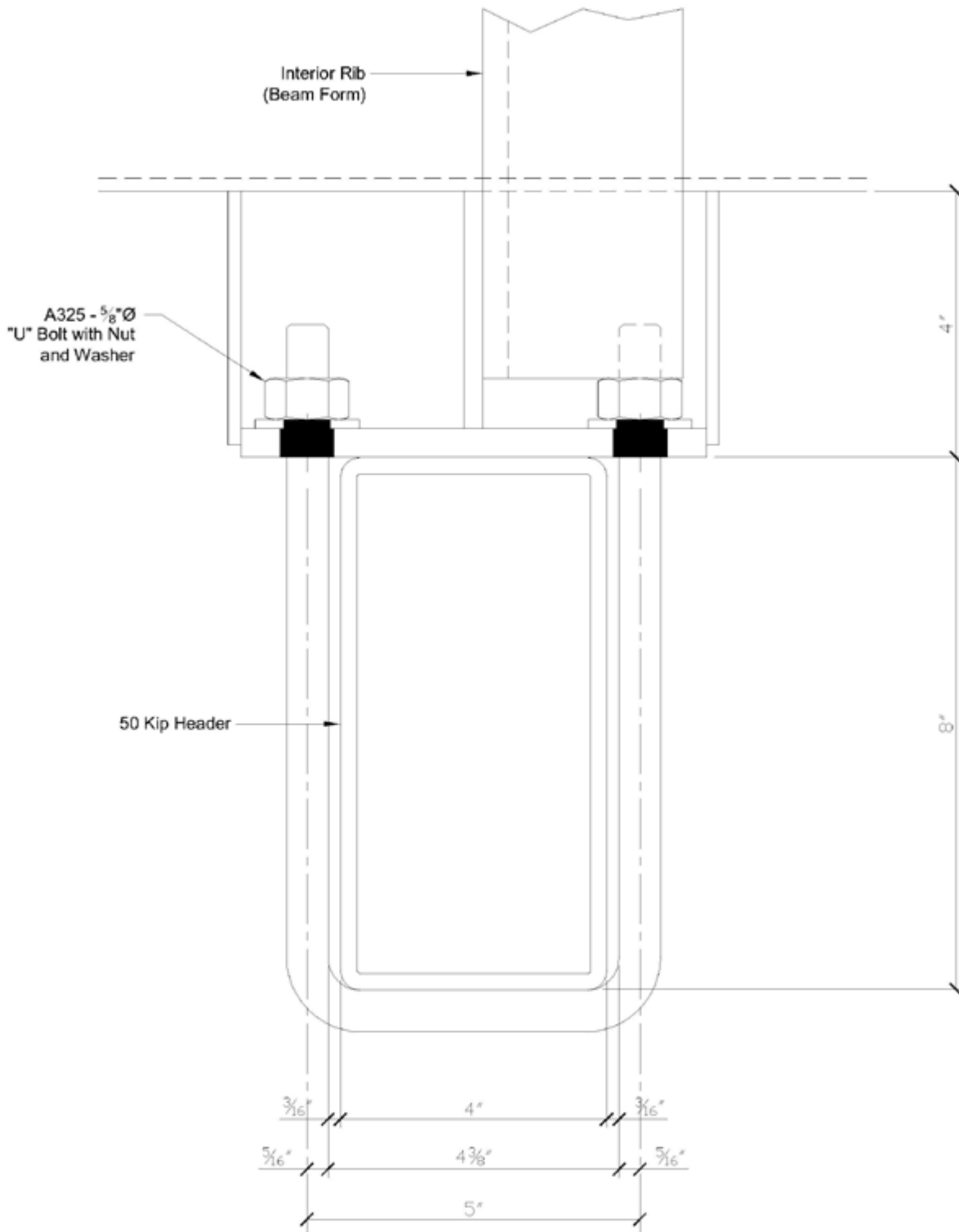

TOOLS, EQUIPMENT & ASSEMBLY DETAILS

**Beam Form to 50 Kip Header Bolt-Up Detail**

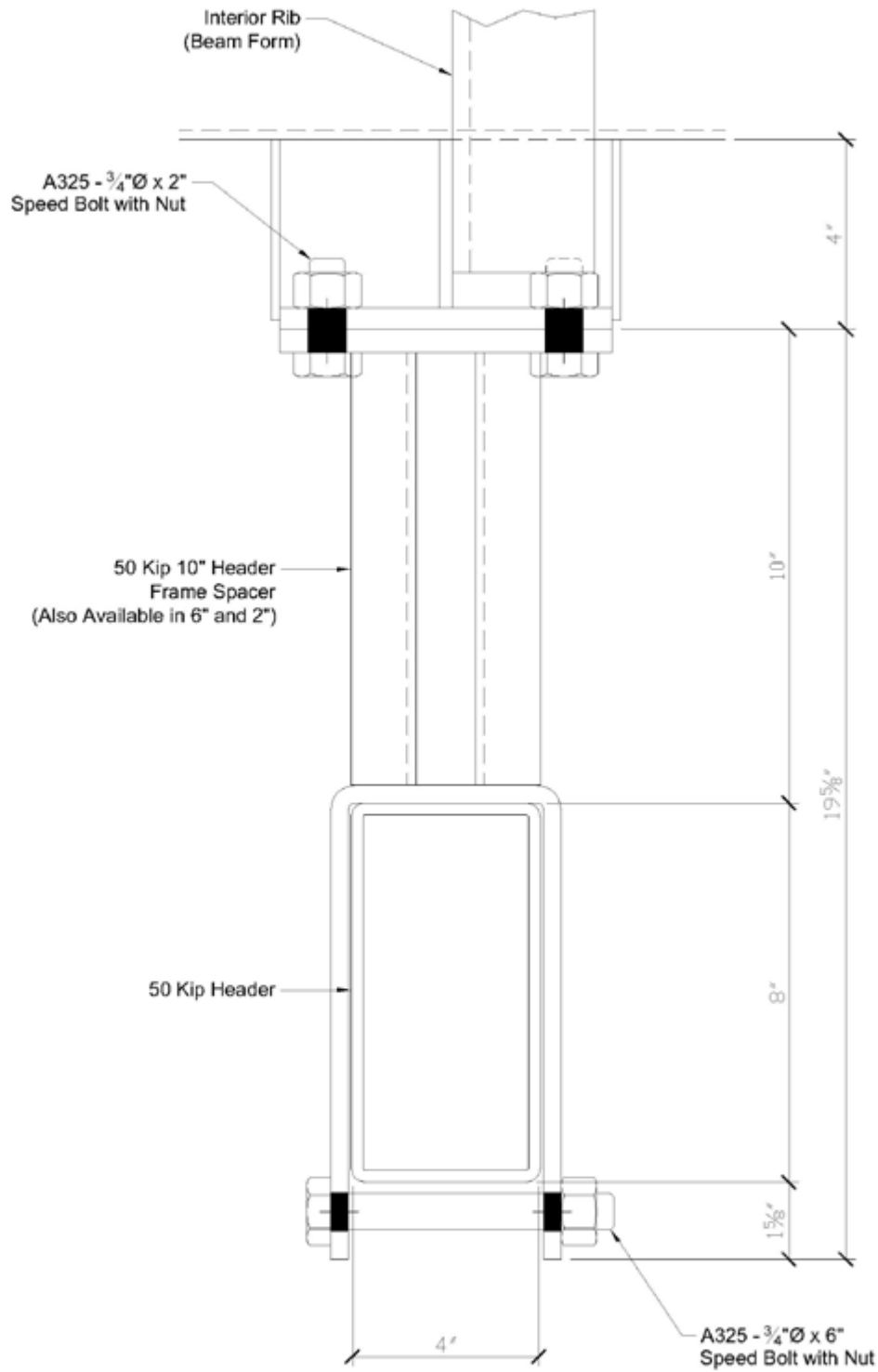

**Beam Form to 50 Kip Header Bolt-Up Detail  
Using 50 Kip Frame Spacer**

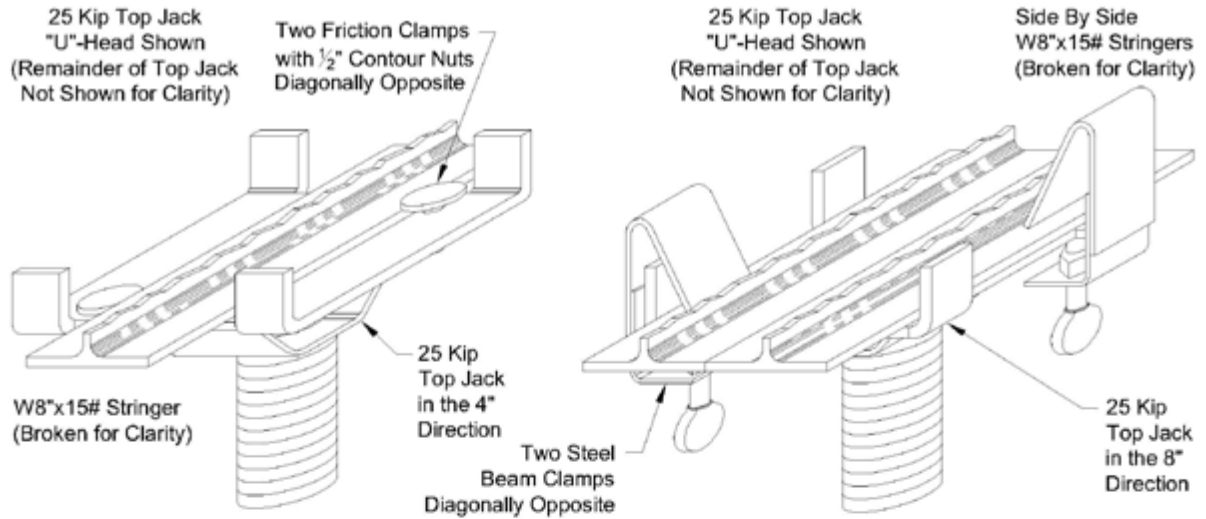

**(Single Stringer Attachment Detail) (Double Stringer Attachment Detail)**

Important Safety Note: All Stringers Must Be Securely Clamped to the 25 Kip Top Jack "U"-Head when in Setting, when in Use, when Stripping and when Transporting the Beam Forms. However, the clamps may be loosened up to slide the Stringers into their proper position along the Beam length and then re-tighten the Clamps as soon as the Stringers are in position.

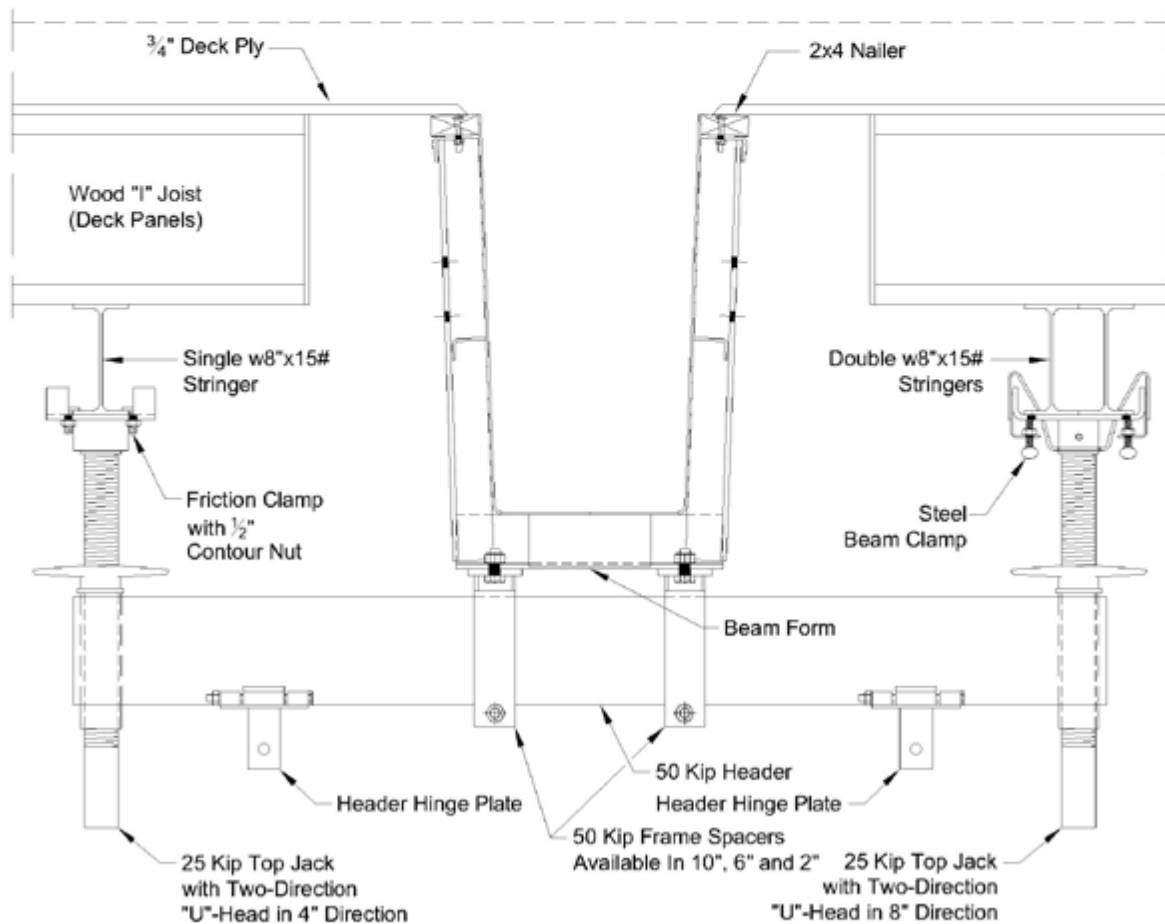

**W8" x 15# Stringer to 25 Kip Top Jack Attachment**

TOOLS, EQUIPMENT & ASSEMBLY DETAILS

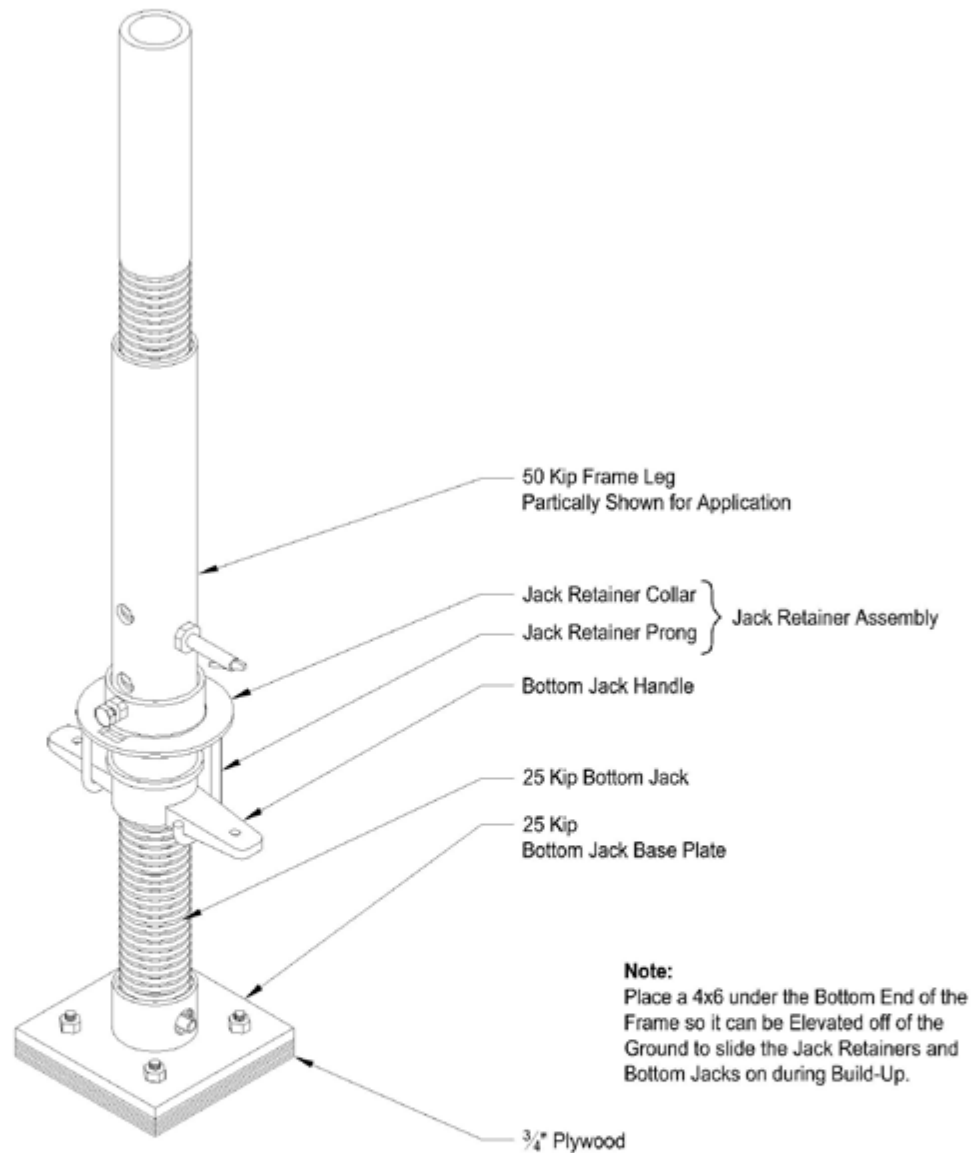

## 25 Kip Bottom Jack and Jack Retainer Assembly

1. Before mounting the 25 Kip Bottom Jack and Retainer on the 25 Kip Frame, be sure that the Bottom Jack has a piece of plywood already bolted to the base plate. (Not to be used with a Slider Leg Extension).
2. Put the Jack Retainer on the Frame Leg with the hooks pointing toward the bottom of the Frame.
3. Place the Retaining Collar on the Frame Leg loosely.
4. Insert the Bottom Jack into the Frame Leg. Be sure to let the hooks on the Jack Retainer wrap around the Jack Handle.
5. Adjust the Retaining Collar so that the Jack Handle can move easily, then tighten the Retaining Collar screw.

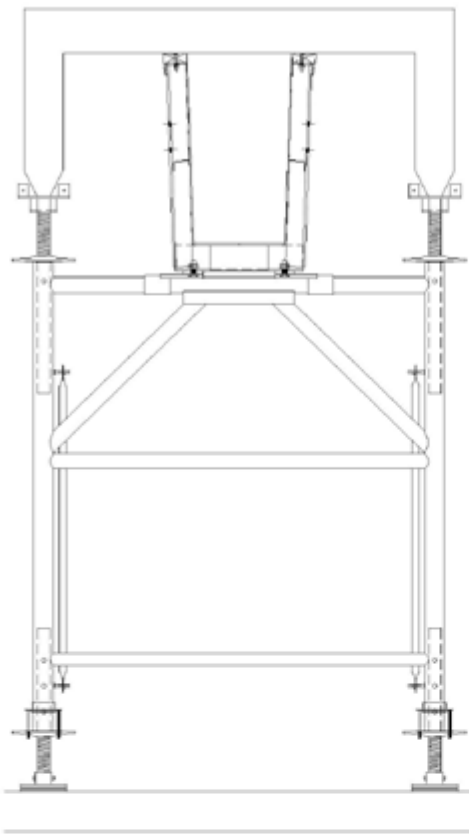

**Level Slab Condition**

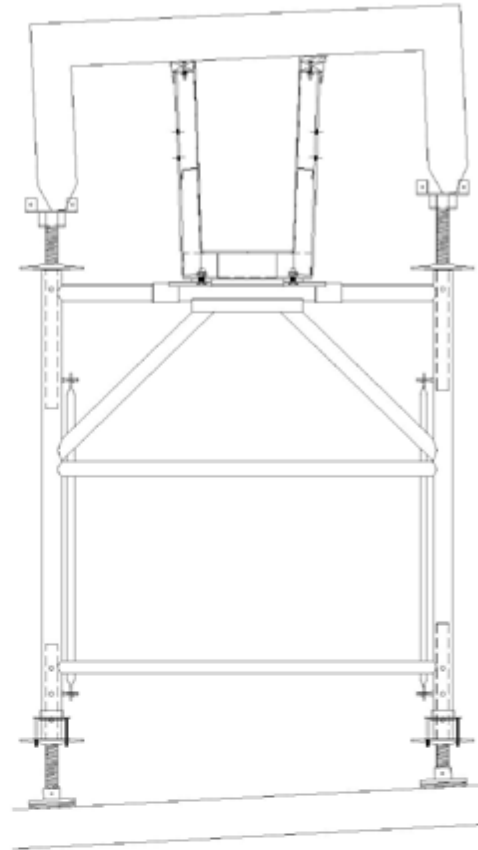

**Ramped Slab Condition**

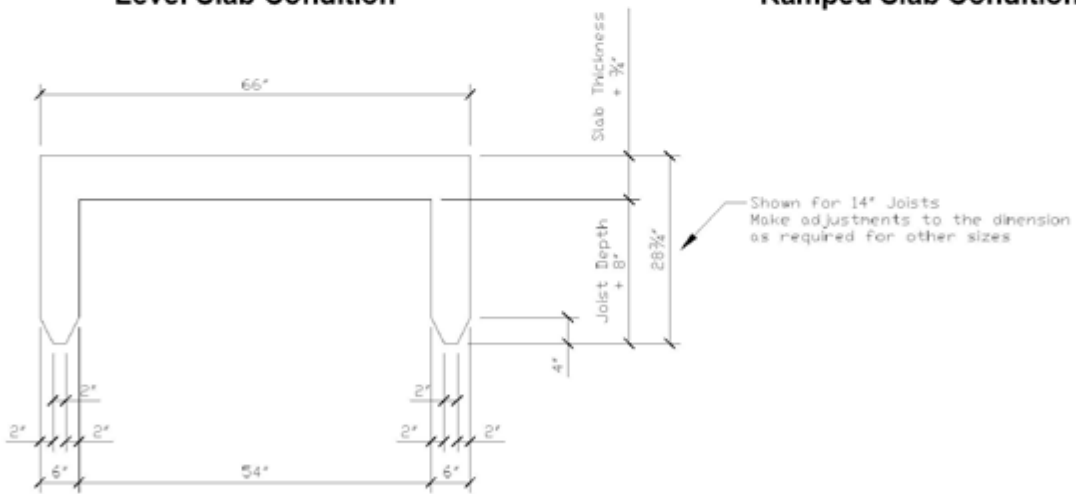

**Plywood Grading Template**

## Top Jack Grading Template and Use

TOOLS, EQUIPMENT &  
ASSEMBLY DETAILS

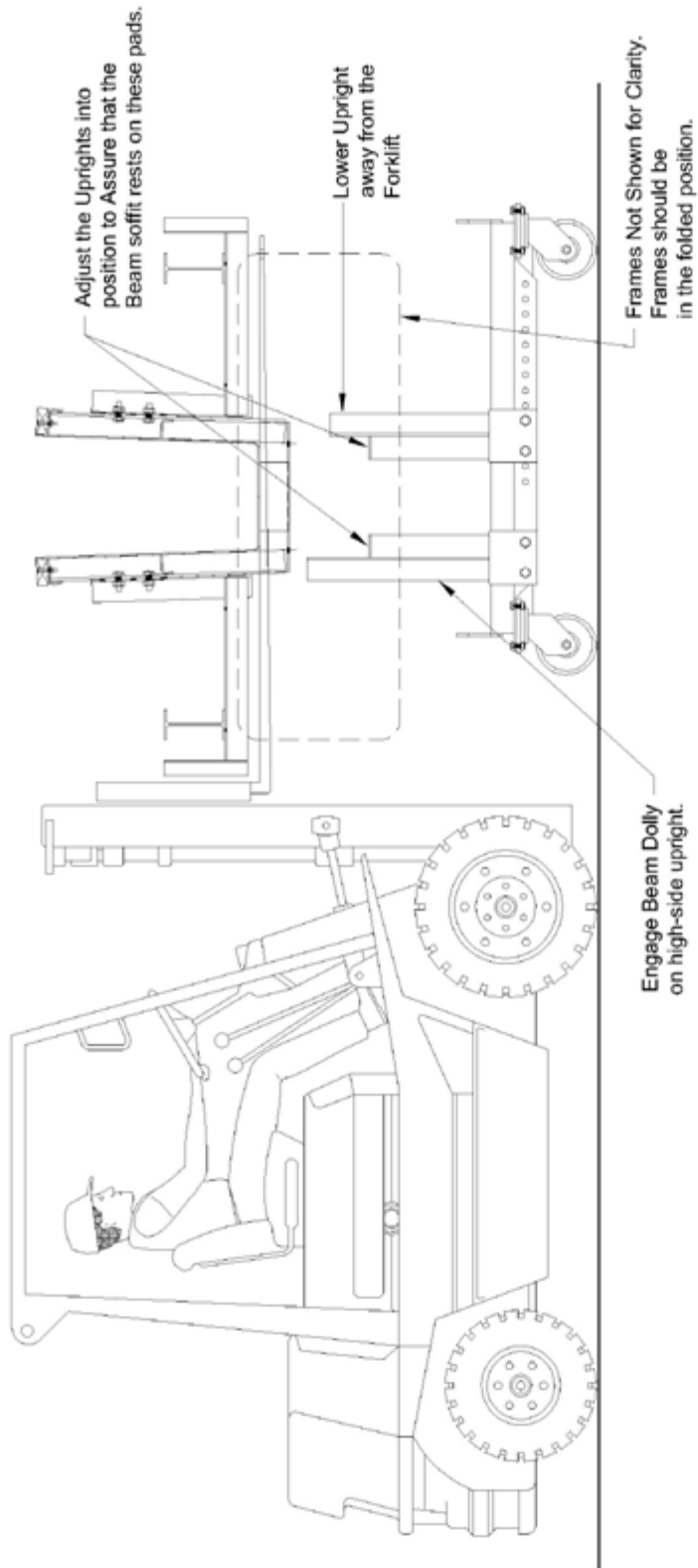

**Note:**  
Make certain that the high side uprights are on the same side of the beam.

## Lowering Beam Form onto Beam Dollies

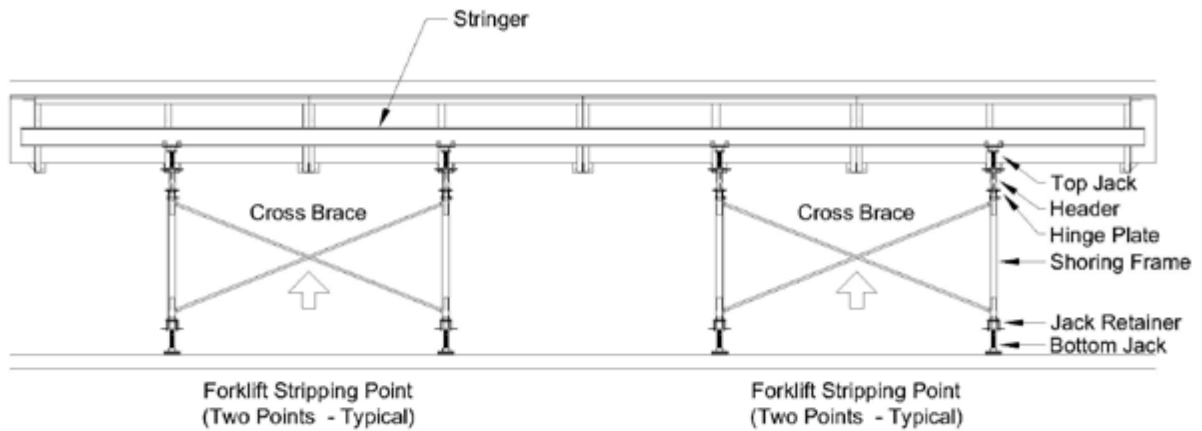

Heavier Beam Form Assemblies May Require  
The Use Of Three Forklifts For Stripping  
(based On The Load Chart On Page C-3)

## Beam Assembly Elevation

TOOLS, EQUIPMENT &  
ASSEMBLY DETAILS

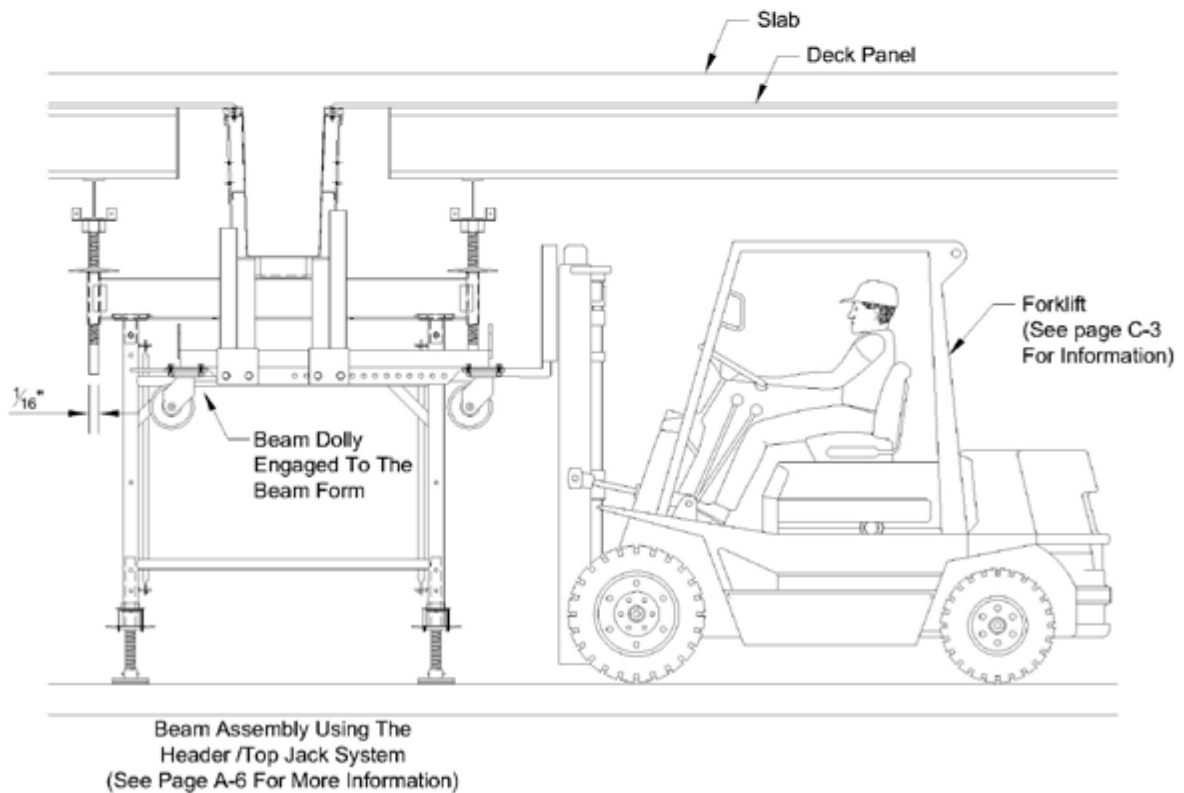

## Handling Beam Form With Header / Top Jack System



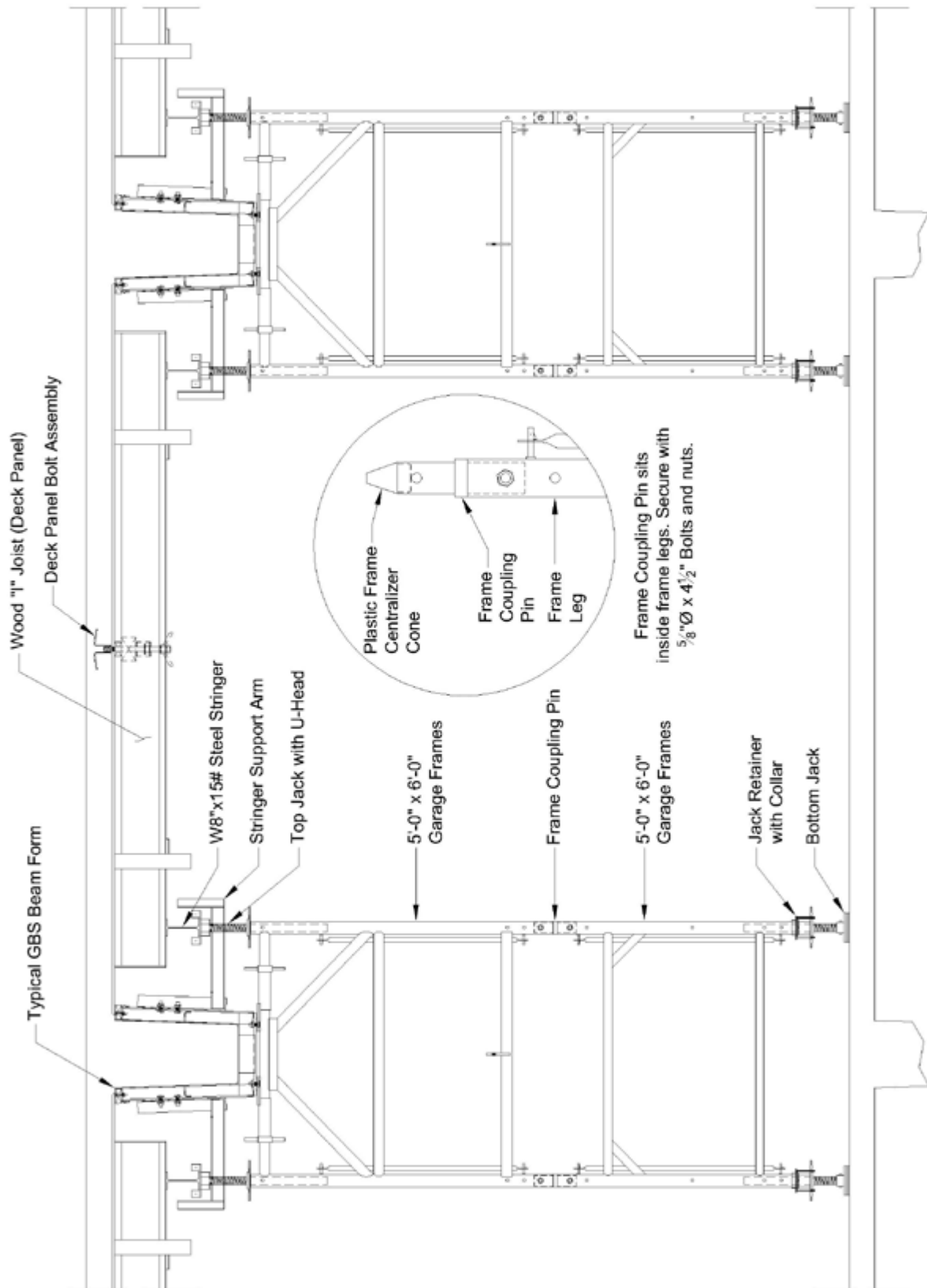

**Beam and Deck Section at High Bay Condition**

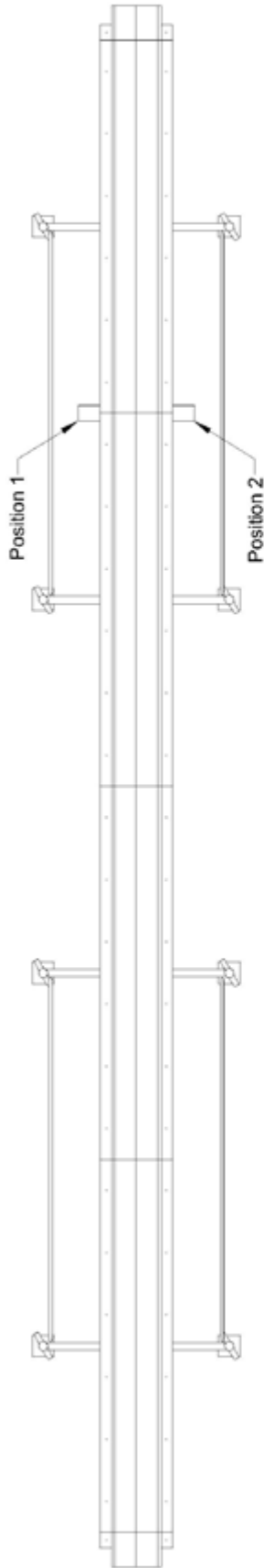

**Plan View**

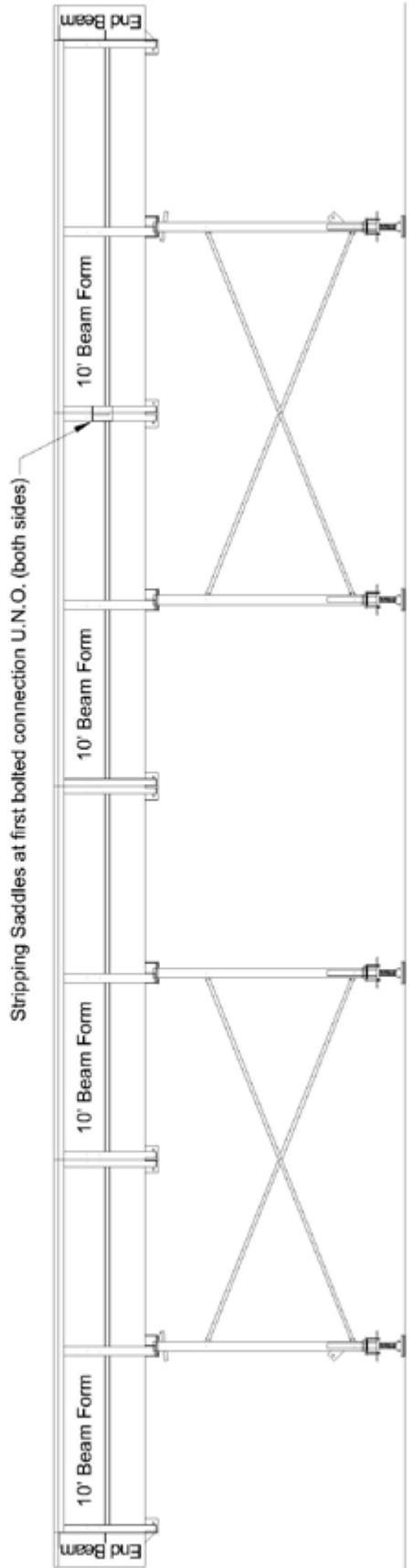

**Elevation View**

## Beam Form Stripping Procedures

NOTE: A SAMPLE BEAM FORM ELEVATION SHOWN, YOUR EQUIPMENT AND SET-UP MAY VARY.  
TWO (2) STRIPPING SADDLES REQUIRED

1. JACK AT POSITION 1 AND 2 SIMULTANEOUSLY UNTIL THE BEAM BREAKS FROM THE CONCRETE.

TYPICAL FIELD  
DETAIL DRAWINGS

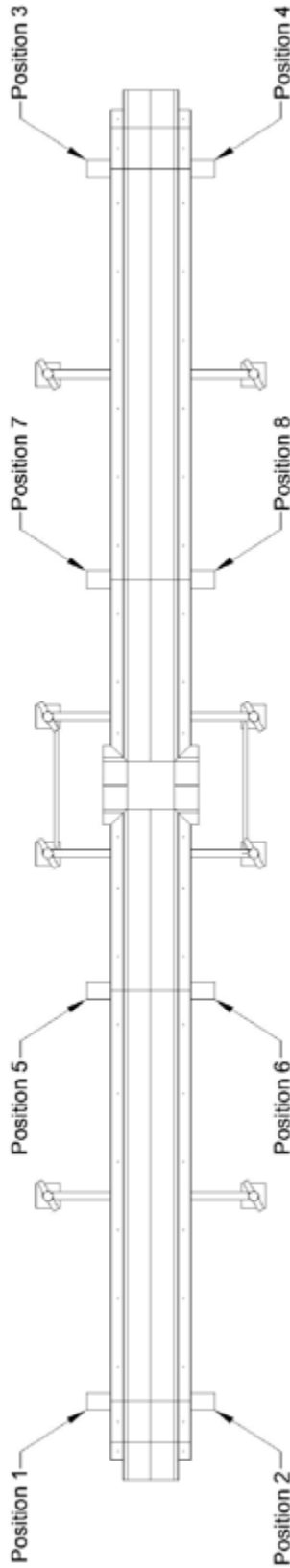

**Plan View**

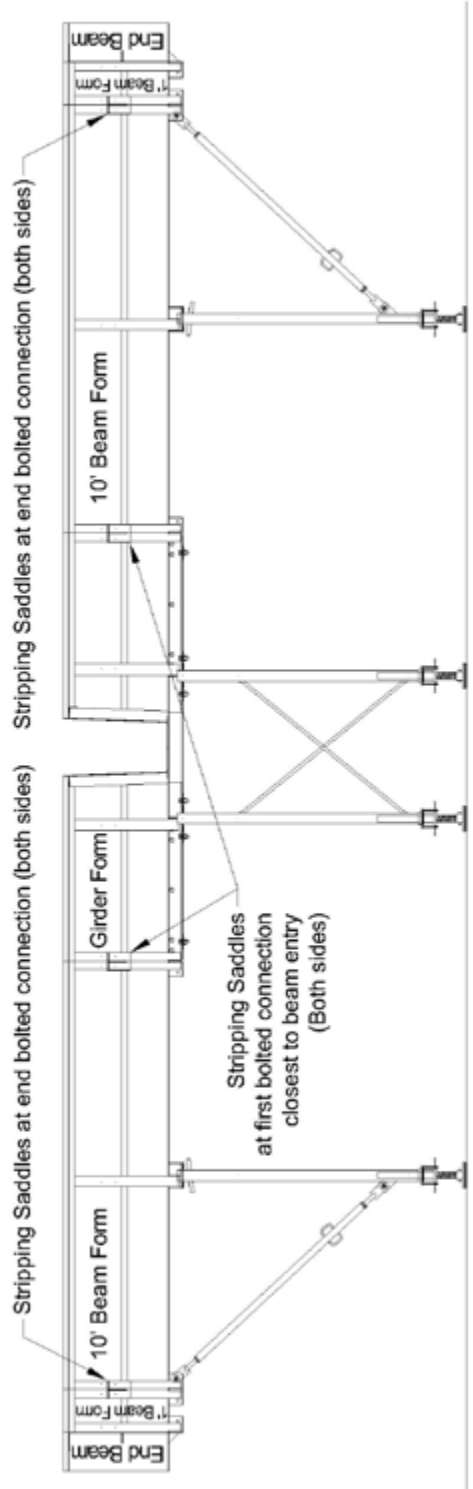

**Elevation View**

## Transfer Girder Stripping Procedures

NOTE: A SAMPLE TRANSFER GIRDER ELEVATION SHOWN, YOUR EQUIPMENT AND SET-UP MAY VARY.

FOUR (4) STRIPPING SADDLES REQUIRED

START BY PLACING THE JACKS AT POSITIONS 1, 2, 3 AND 4.

1. JACK AT POSITION 1 AND 2 UNTIL THE GIRDER BREAKS 2" FROM THE CONCRETE.
2. JACK AT POSITION 3 AND 4 UNTIL THE GIRDER BREAKS 2" FROM THE CONCRETE.  
MOVE THE JACKS TO POSITIONS 5, 6, 7 AND 8

3. JACKS AT POSITIONS 5, 6, 7 AND 8 SIMULTANEOUSLY OR IN INTERVALS AT JACKS 5 AND 8, THEN AT JACK 6 AND 7 UNTIL THE GIRDER BREAK FREE

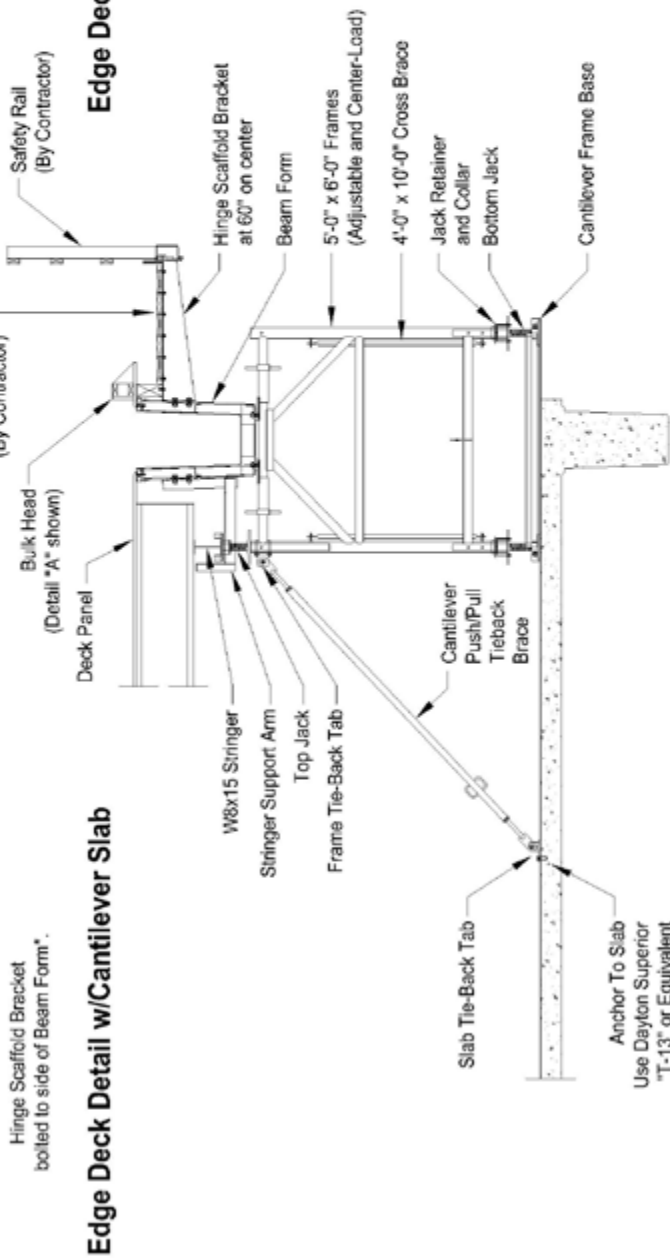
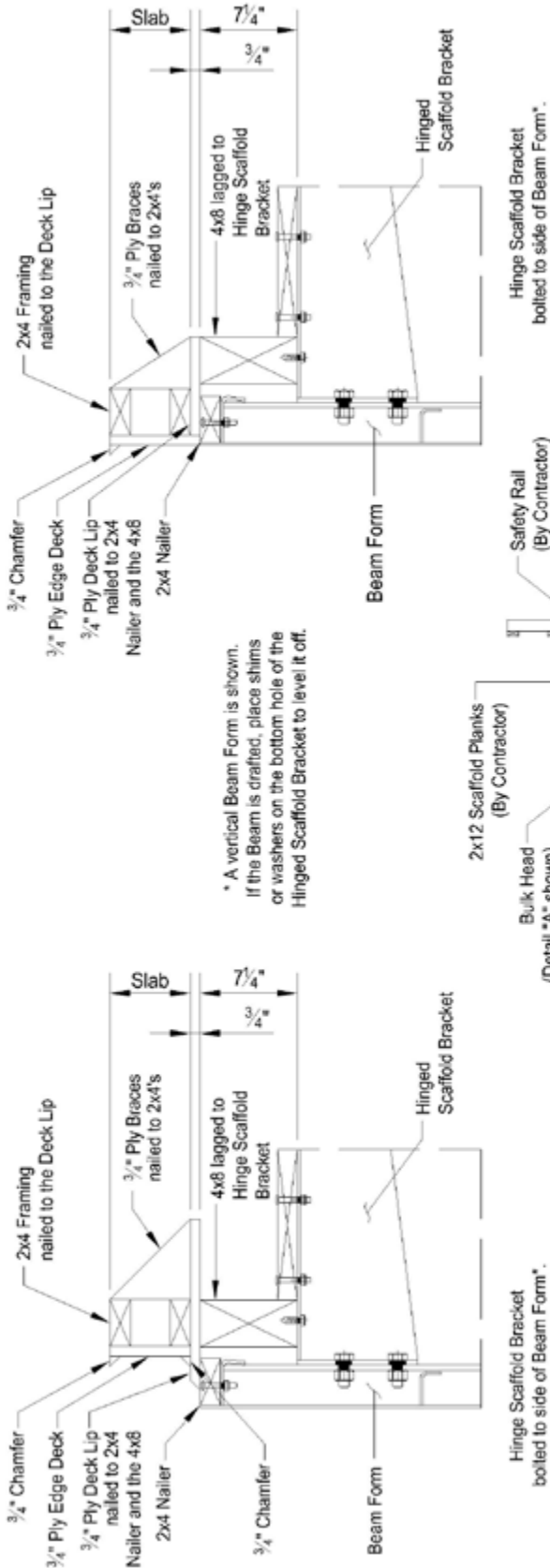

 TYPICAL FIELD  
 DETAIL DRAWINGS

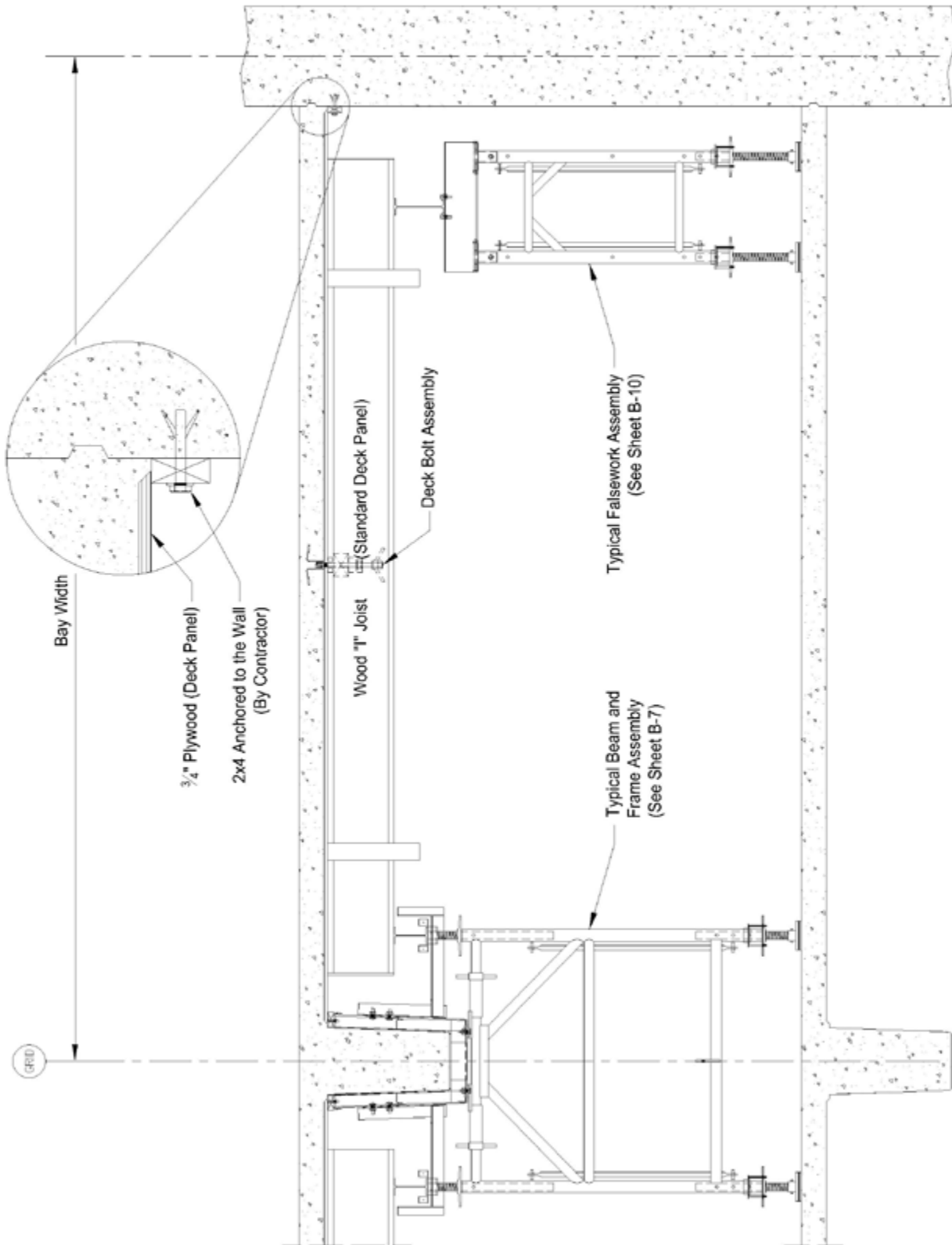

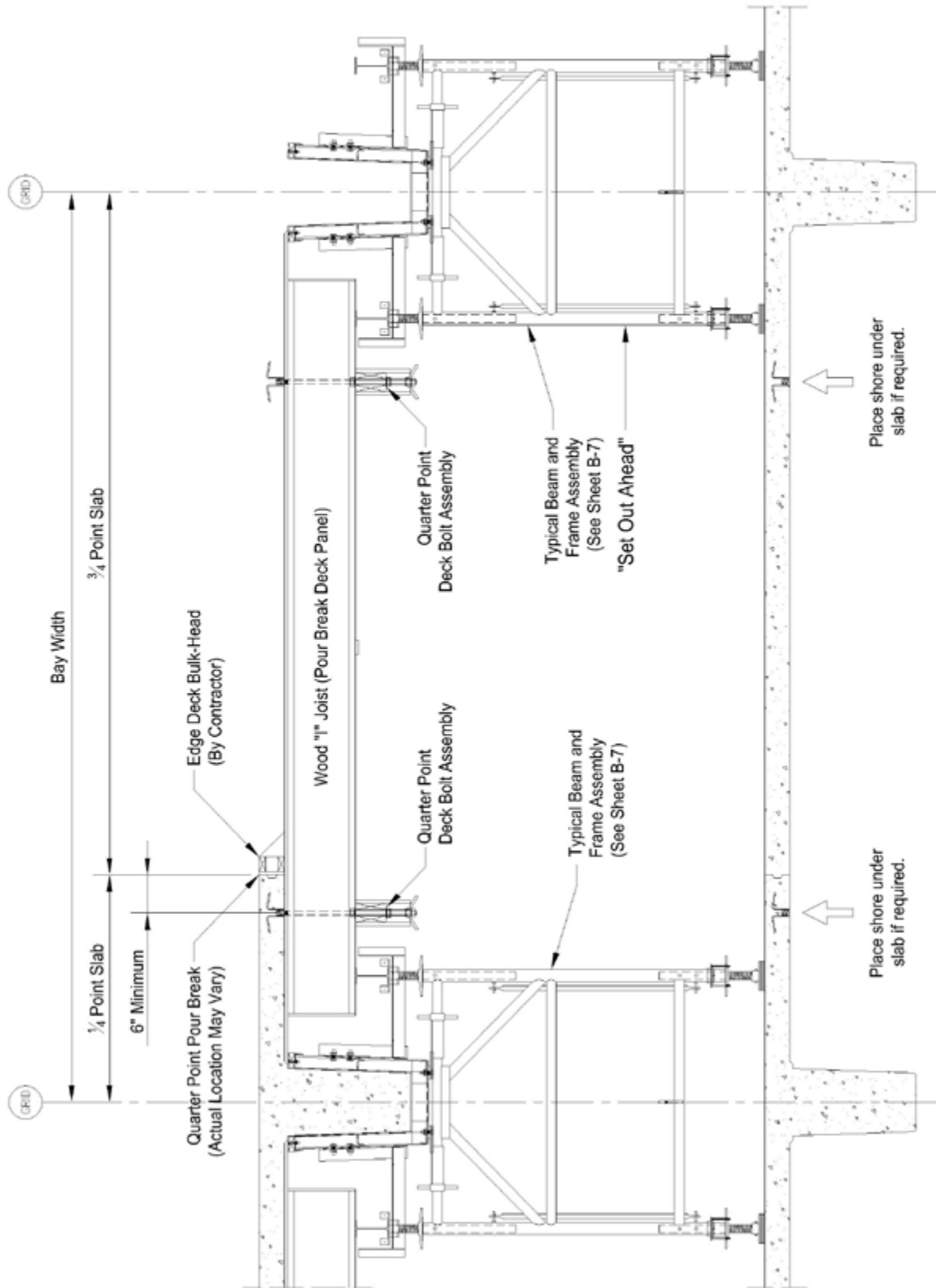

## Falsework Assembly Usage at Wall

TYPICAL FIELD  
DETAIL DRAWINGS



**Section at Quarter Point Pour Break : First Side Pour**

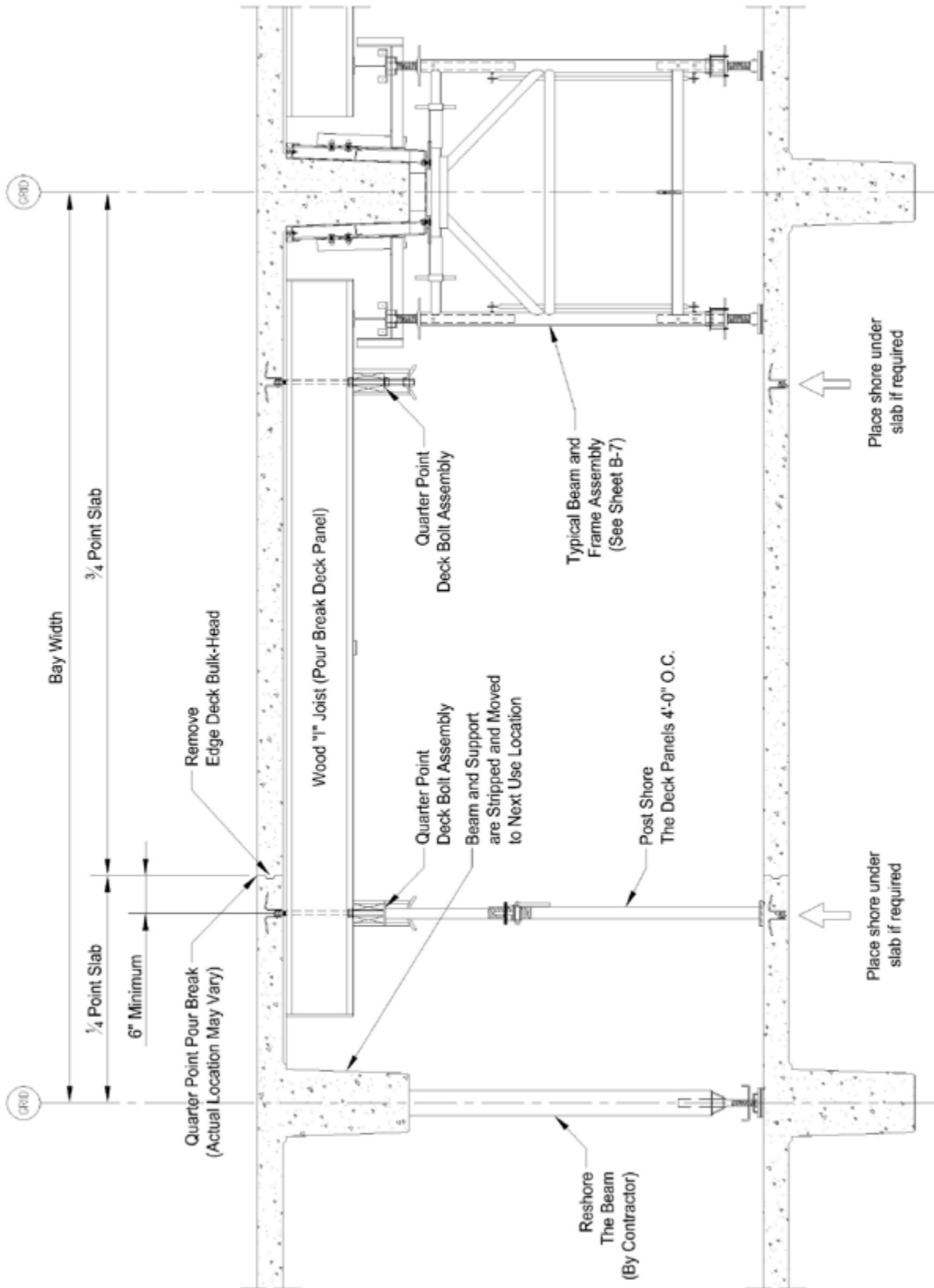

## Section at Quarter Point Pour Break : Second Side Pour

TYPICAL FIELD  
DETAIL DRAWINGS



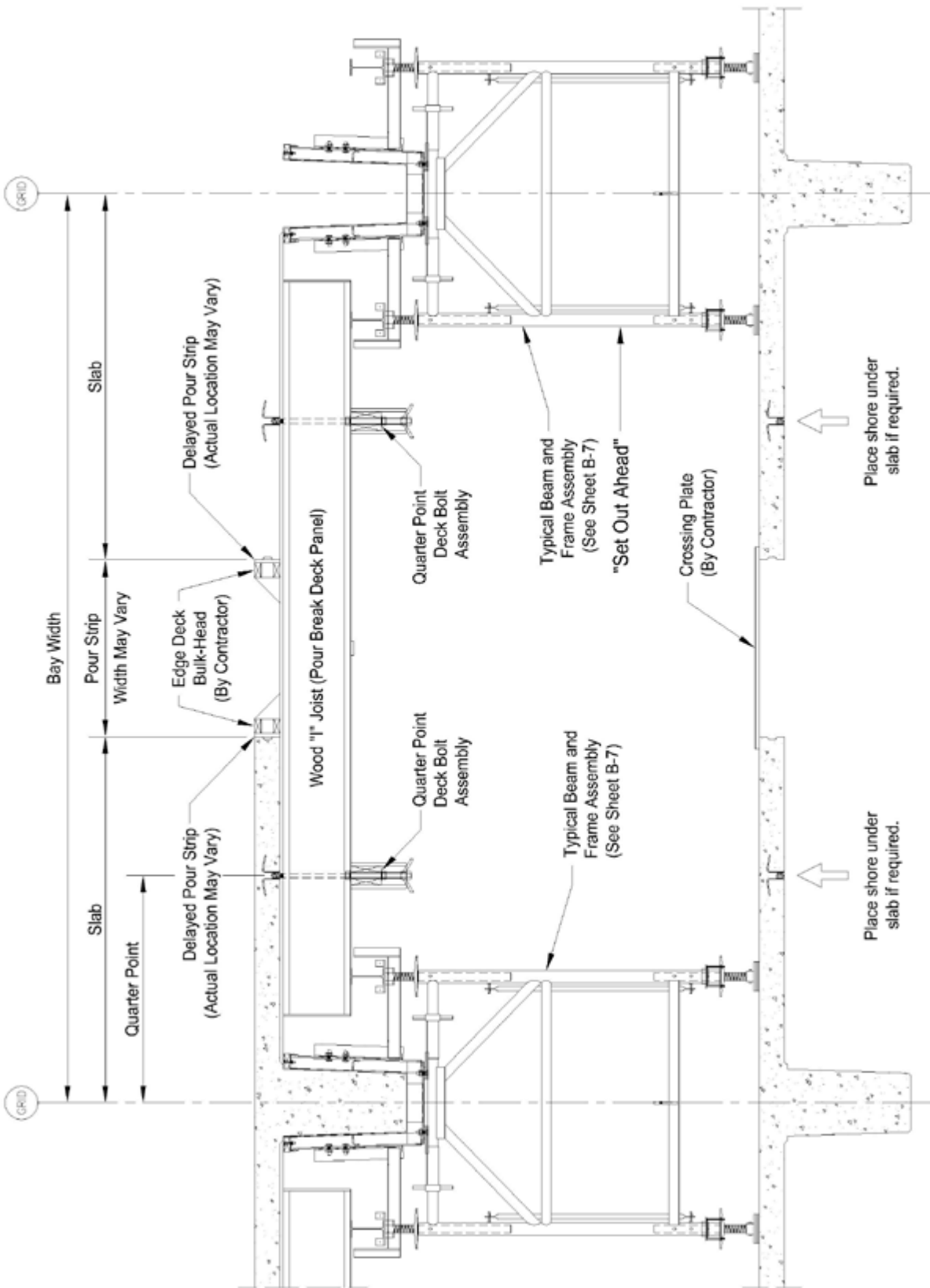

**Section at Delayed Pour Strip : First Side Pour**

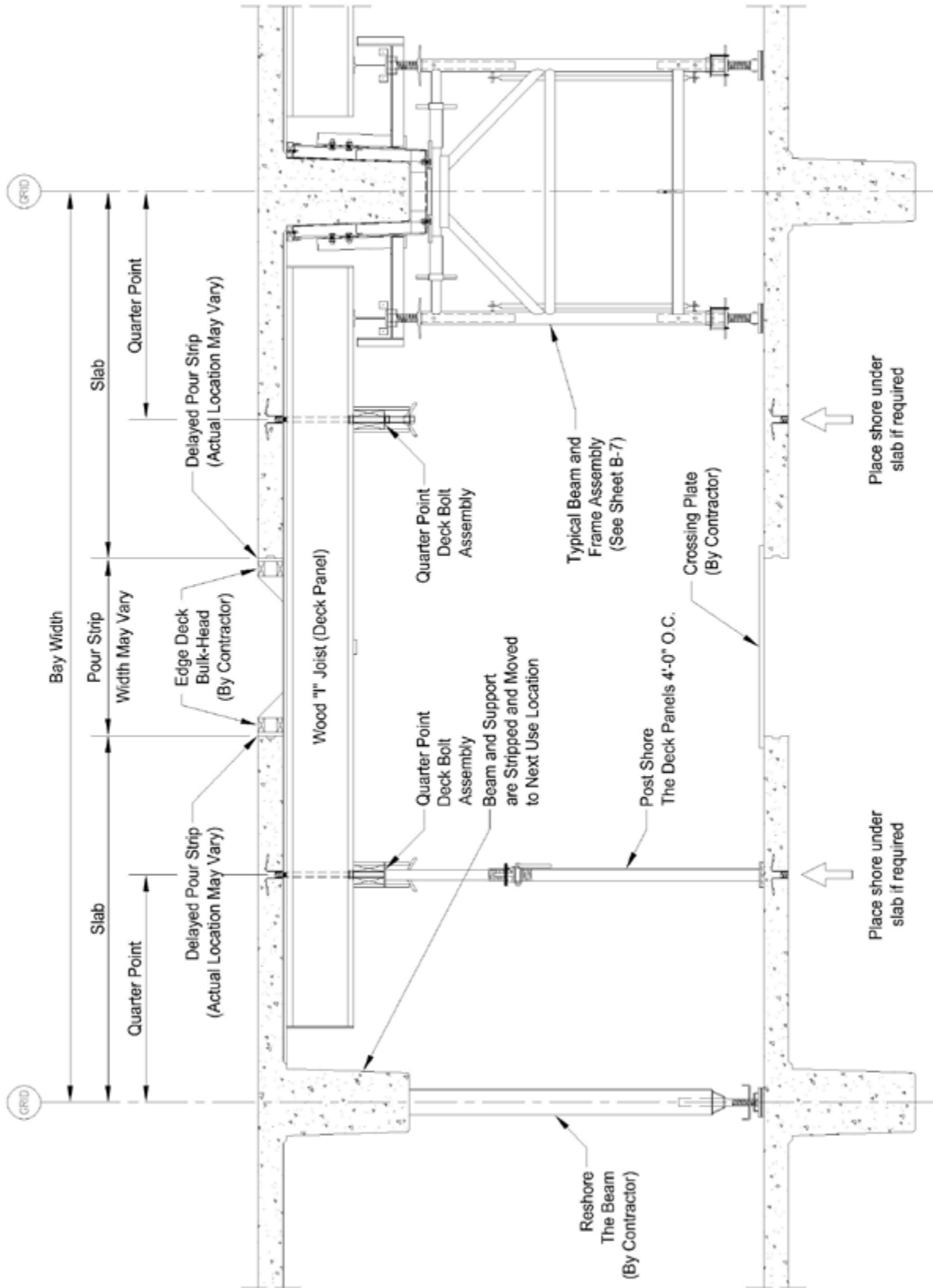

**Section at Delayed Pour Strip : Second Side Pour**

TYPICAL FIELD  
DETAIL DRAWINGS

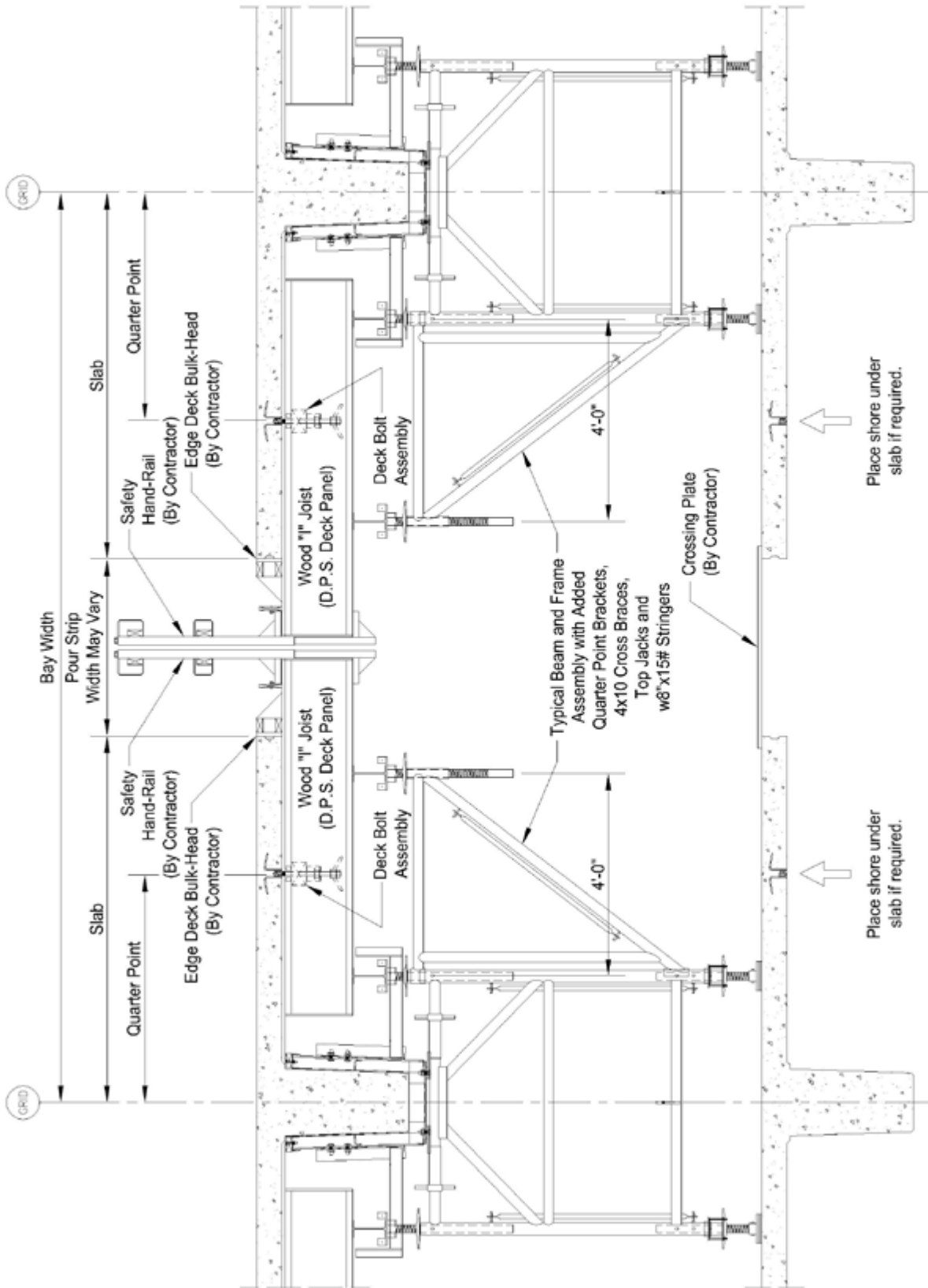

**Section at Delayed Pour Strip : Full Floor of Equipment**

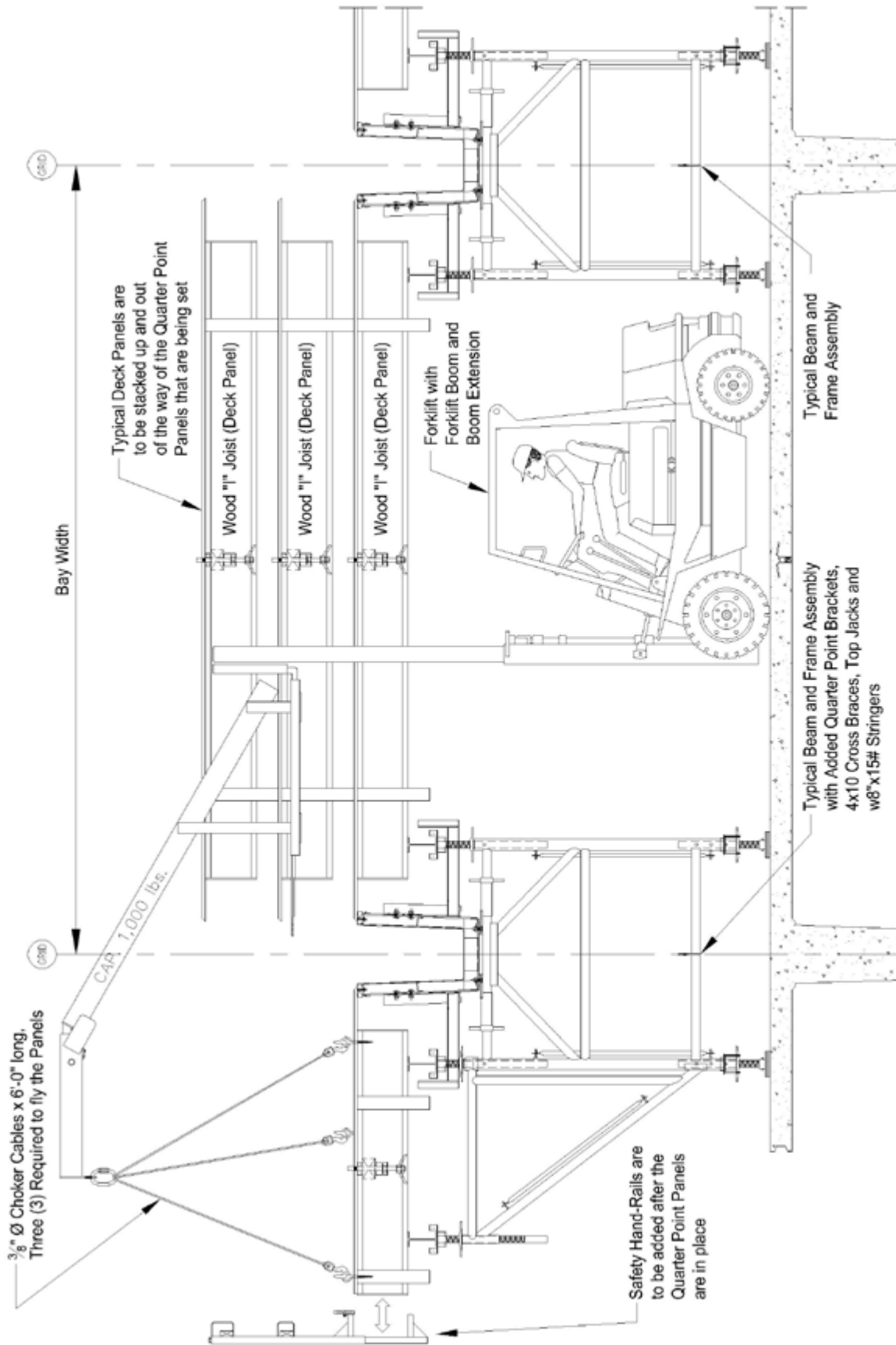

## Quarter Point Deck Panel Placement

TYPICAL FIELD  
DETAIL DRAWINGS

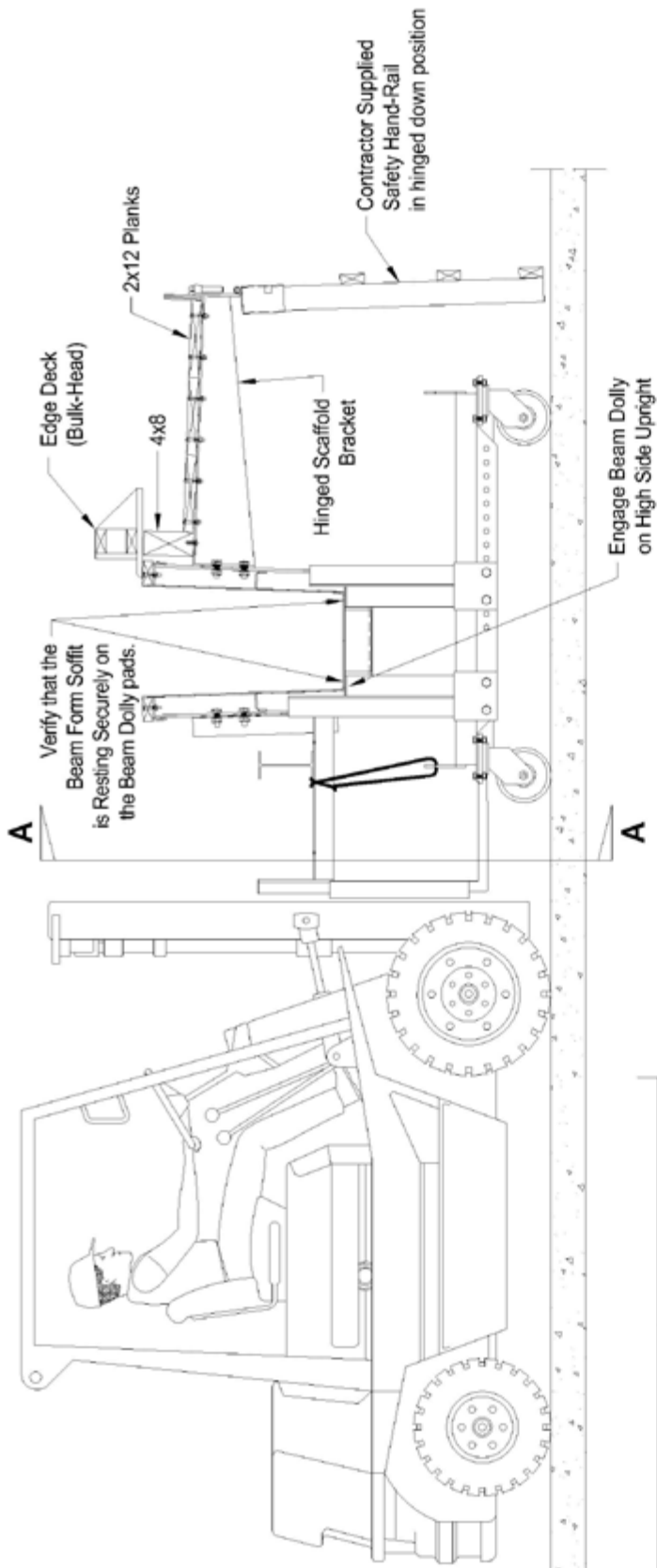

- Notes:**
1. Frames are Not Shown for Clarity and should be in the folded position.
  2. When stripping the Beam Form make sure that the Stringer Support Arm clears the top of the Forklift mast before lowering.

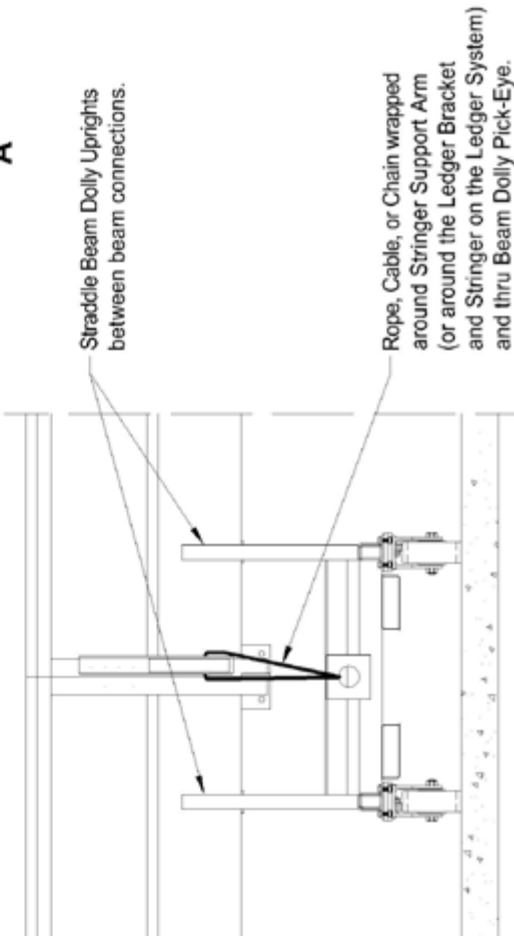

Section A-A

### Beam Dolly Engagement at Perimeter Beam

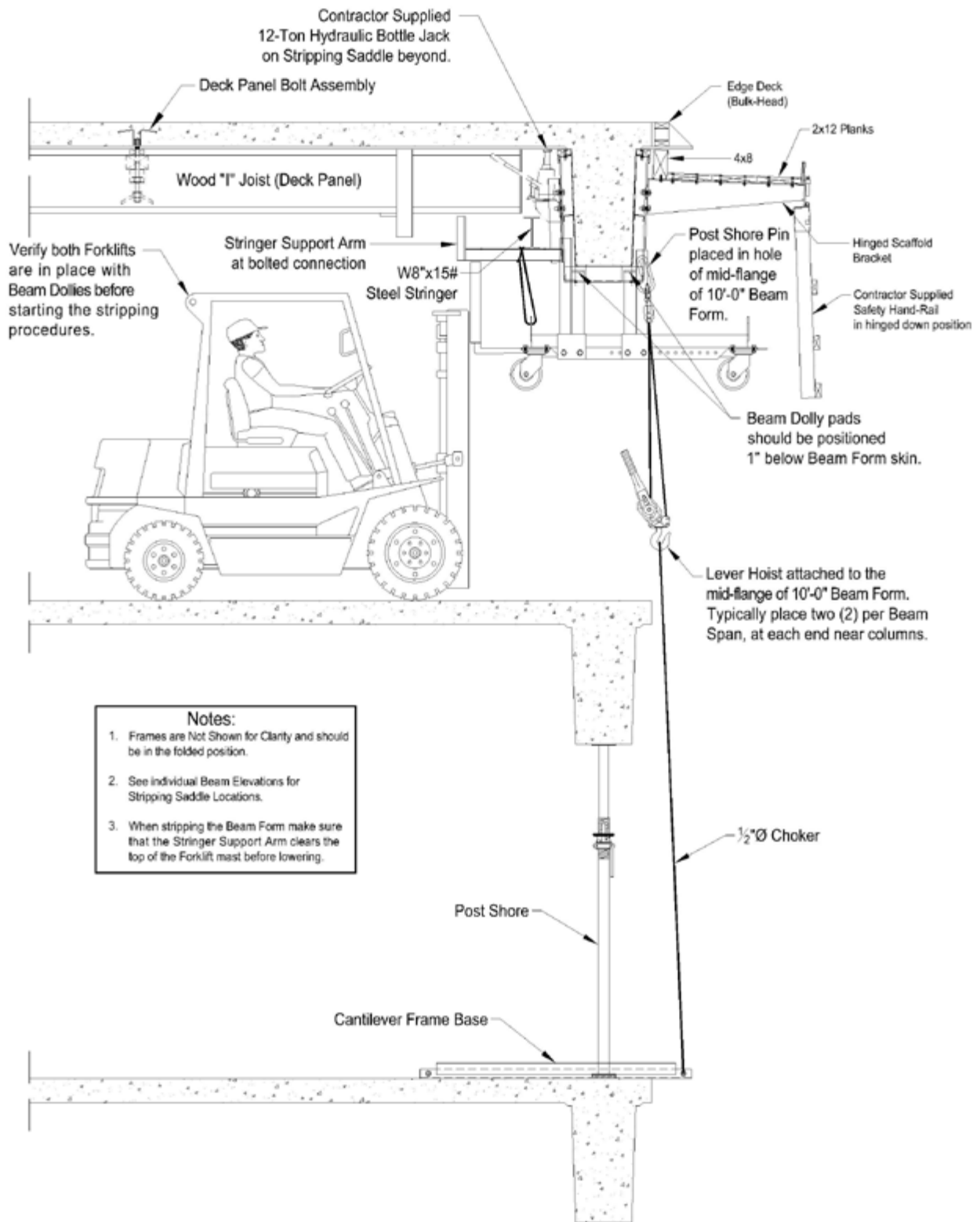

- Notes:**
1. Frames are Not Shown for Clarity and should be in the folded position.
  2. See individual Beam Elevations for Stripping Saddle Locations.
  3. When stripping the Beam Form make sure that the Stringer Support Arm clears the top of the Forklift mast before lowering.

TYPICAL FIELD  
DETAIL DRAWINGS

## Vertical Beam Stripping Detail at Perimeter

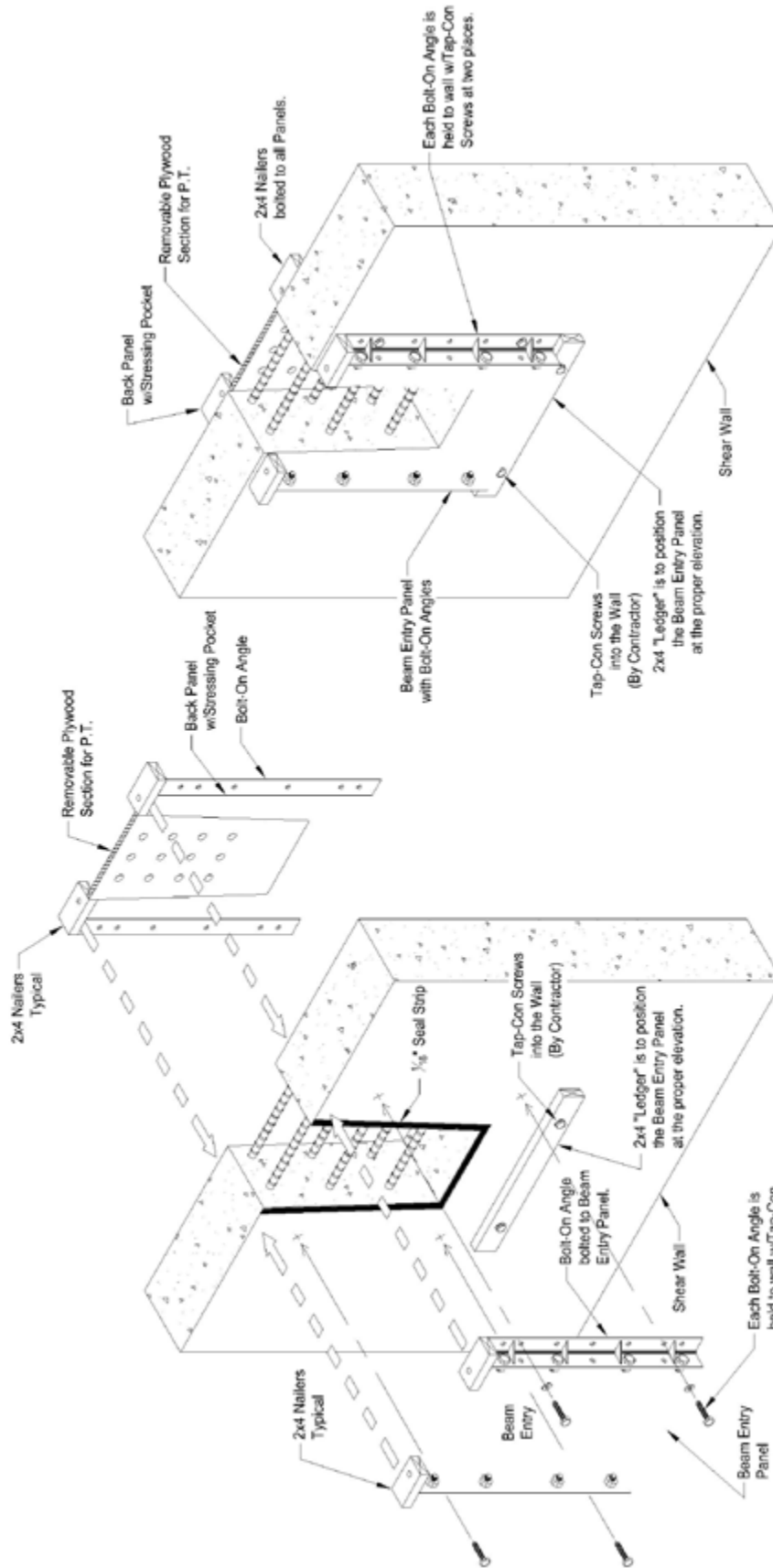

**Assembled View**

**Exploded View**

**Steel Capital at Shear Wall**

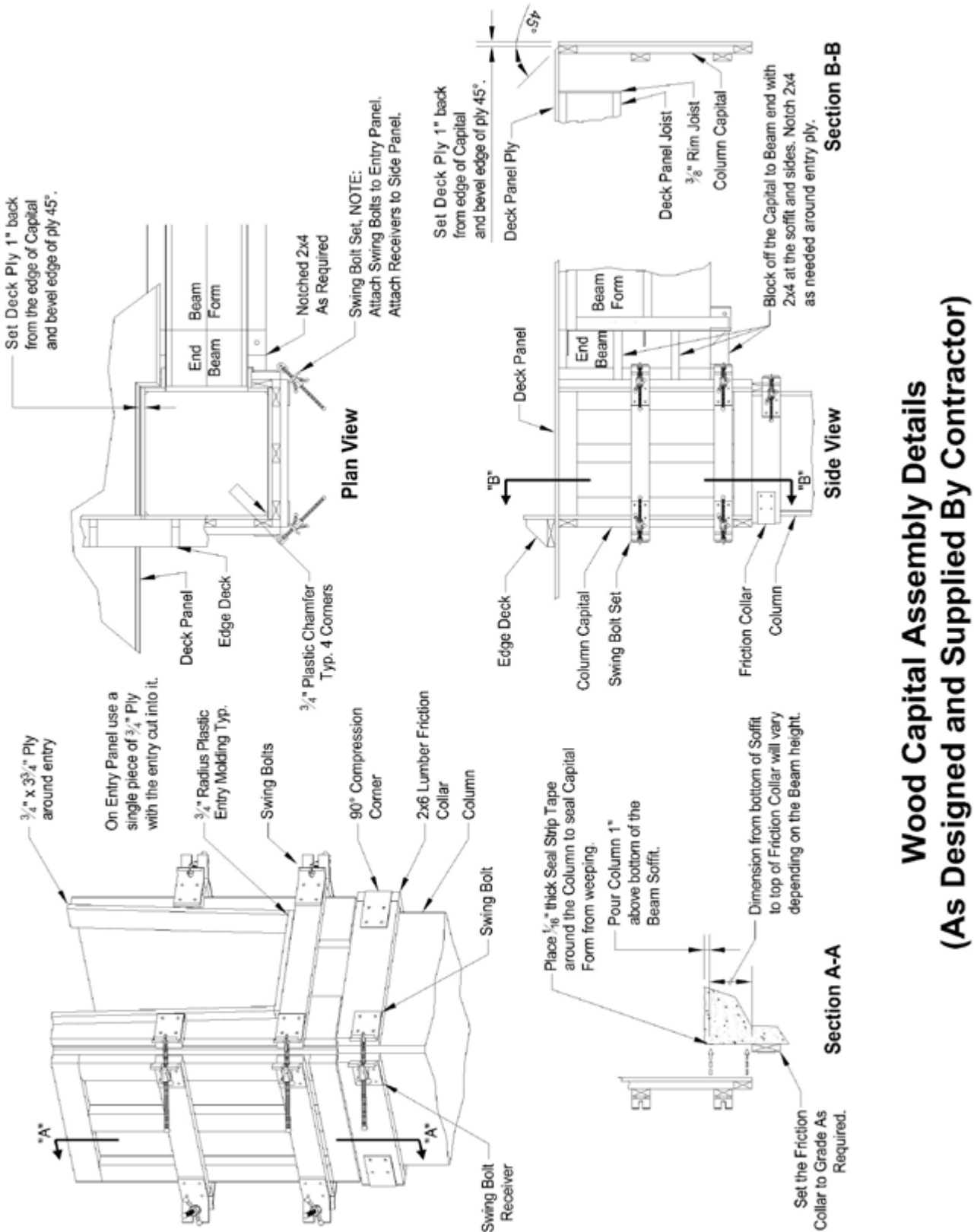

## Wood Capital Assembly Details (As Designed and Supplied By Contractor)

TYPICAL FIELD  
DETAIL DRAWINGS



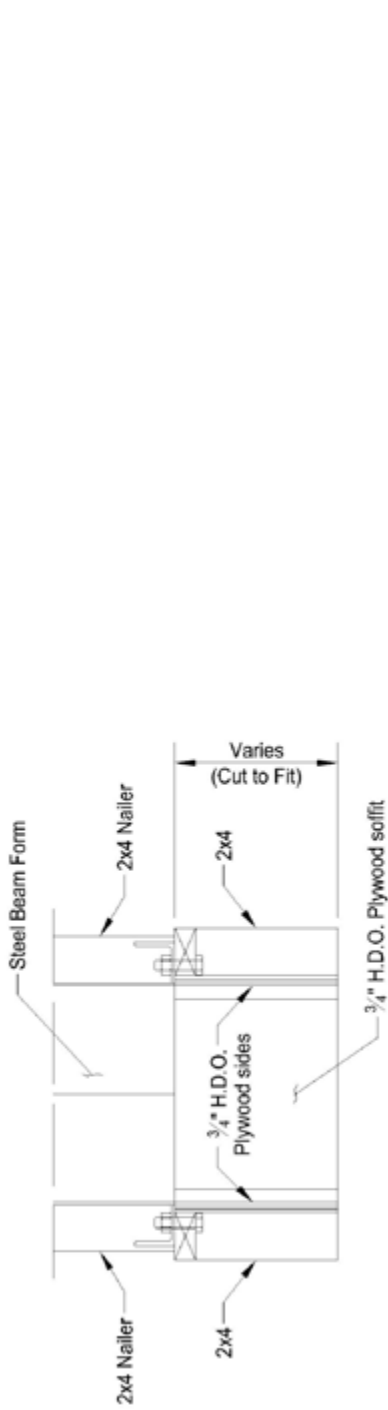

**Top View**

All 2x4's are bolted to the Beam Form End Flanges with 3/4"Ø x 3" bolts and set back by 3/4"

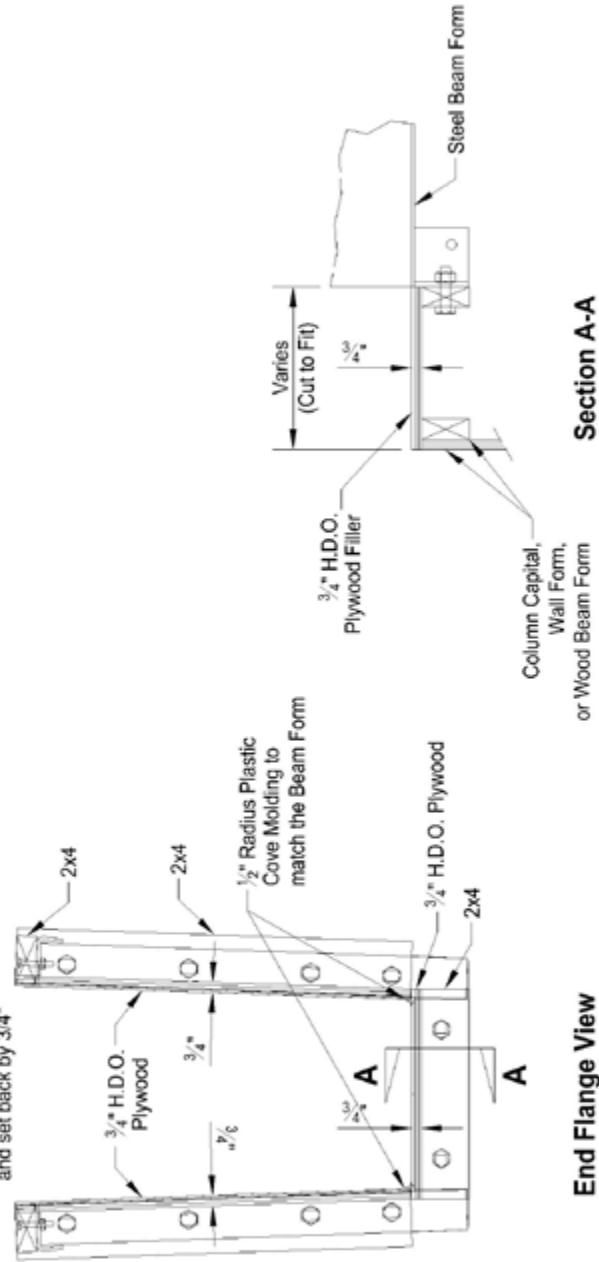

**End Flange View**

**Section A-A**

## Plywood Beam Extension Connection Detail



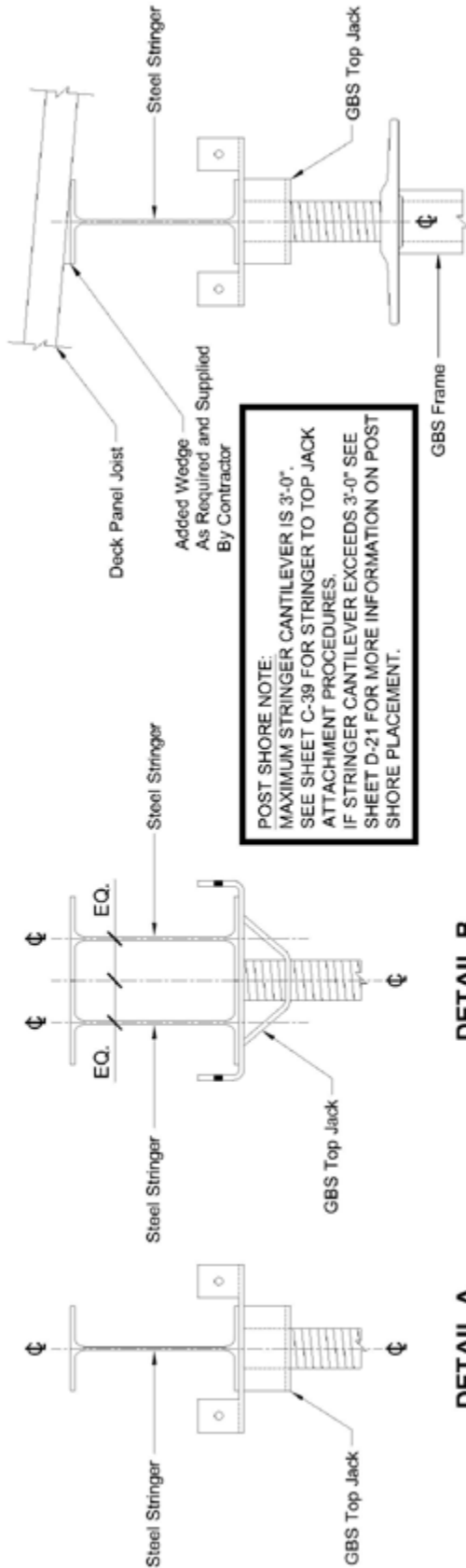

**Stringer Detail at Sloping Slab**

**DETAIL A**  
**(Typical at Single Stringer)** **DETAIL B**  
**(Typical at Lapped Stringers)**

**Top Jack Details**

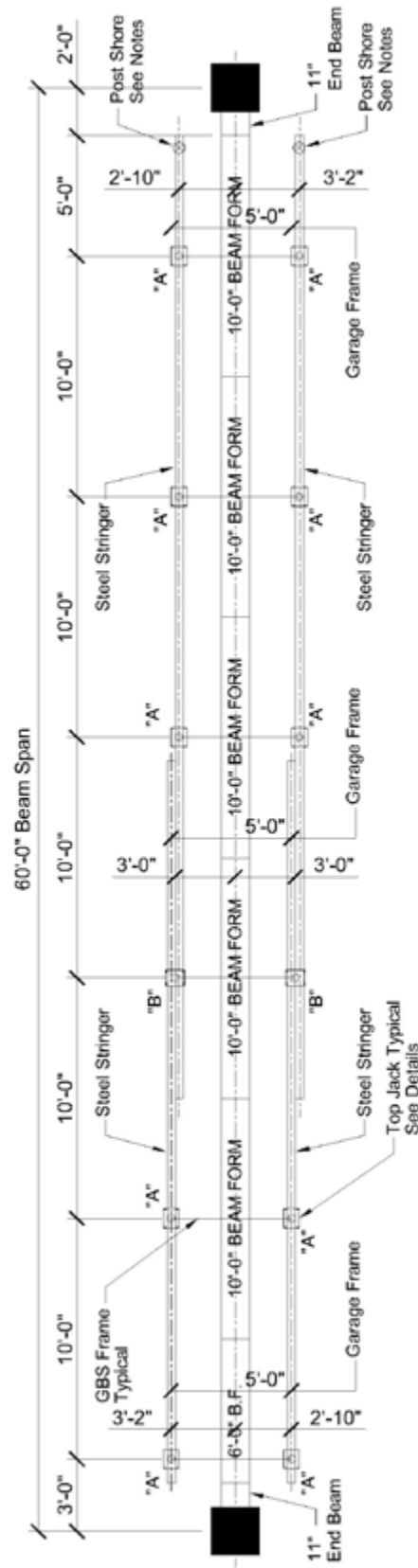

**Plan View**

**Typical Top Jack Frame/Stringer Offset Procedure**

TOP JACK SYSTEM SHOWN, HEADER/TOP JACK SYSTEM SIMILAR

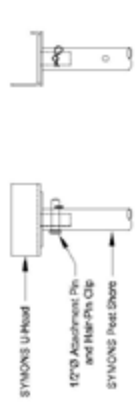
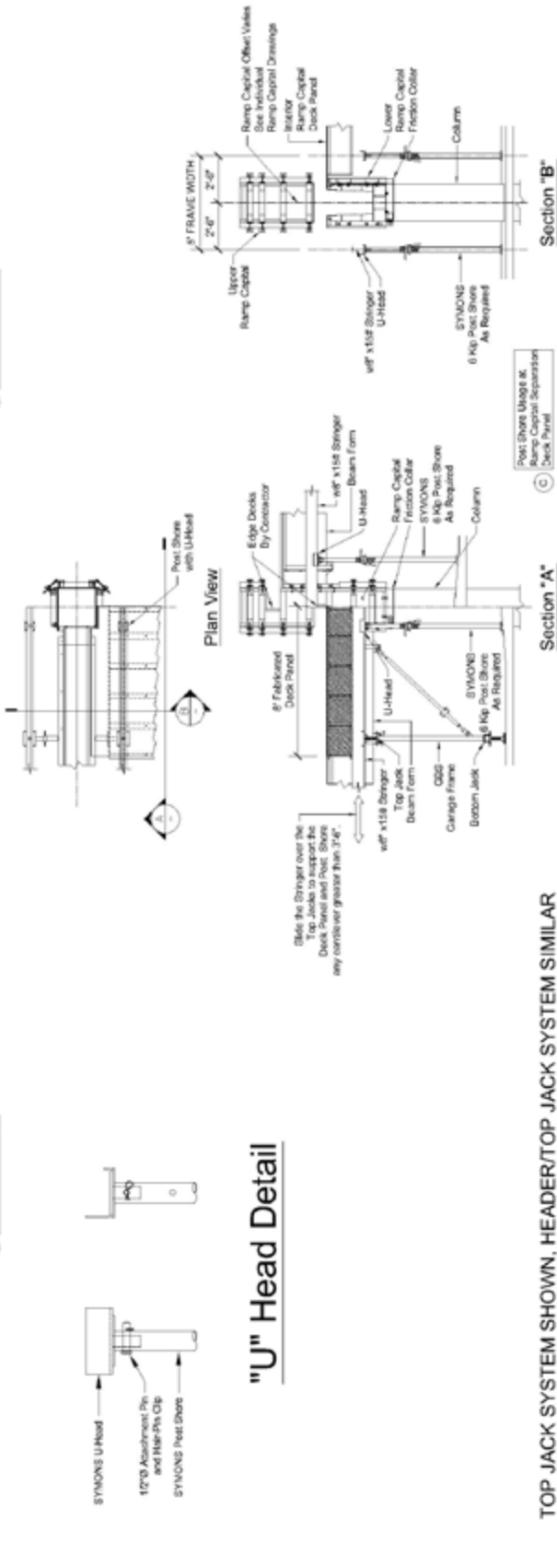
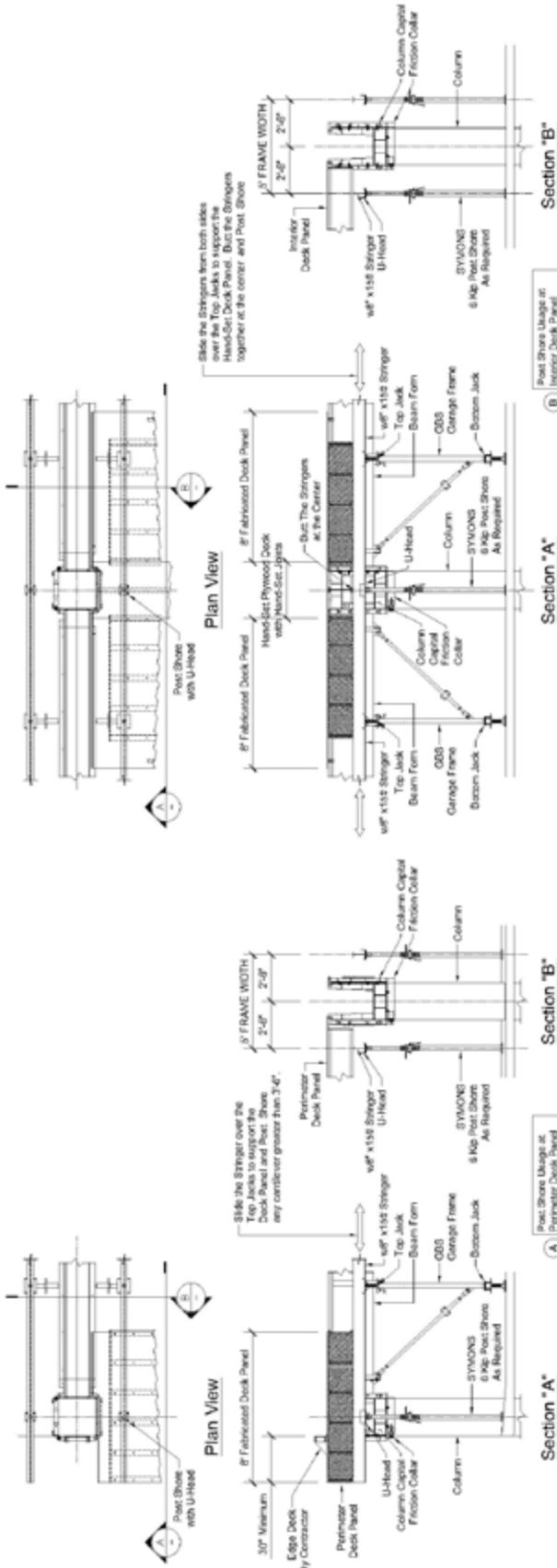

"U" Head Detail

TOP JACK SYSTEM SHOWN, HEADER/TOP JACK SYSTEM SIMILAR  
**Typical Top Jack System Post Shore Details**

TYPICAL FIELD  
 DETAIL DRAWINGS

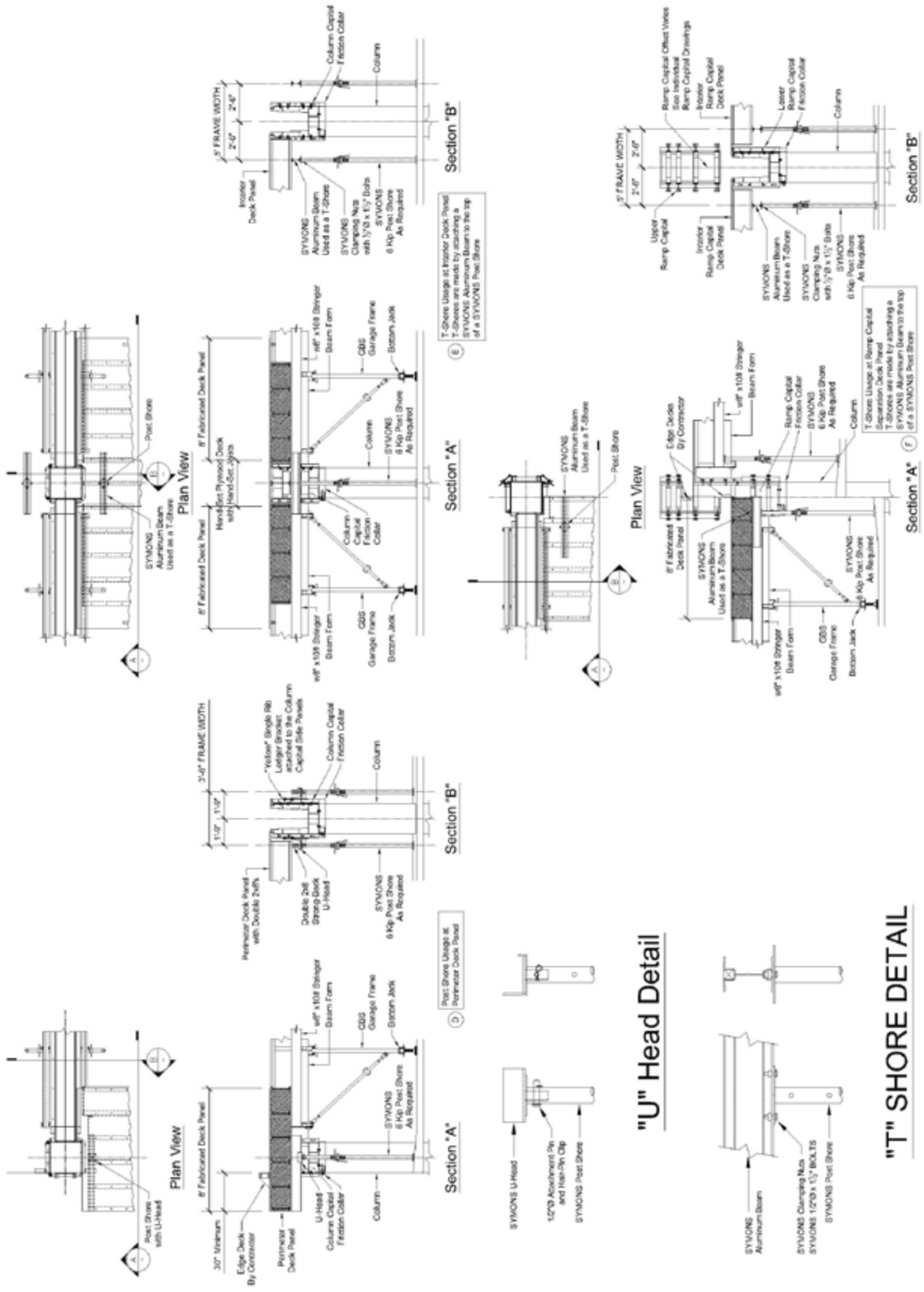

### Typical Ledger System Post Shore Details

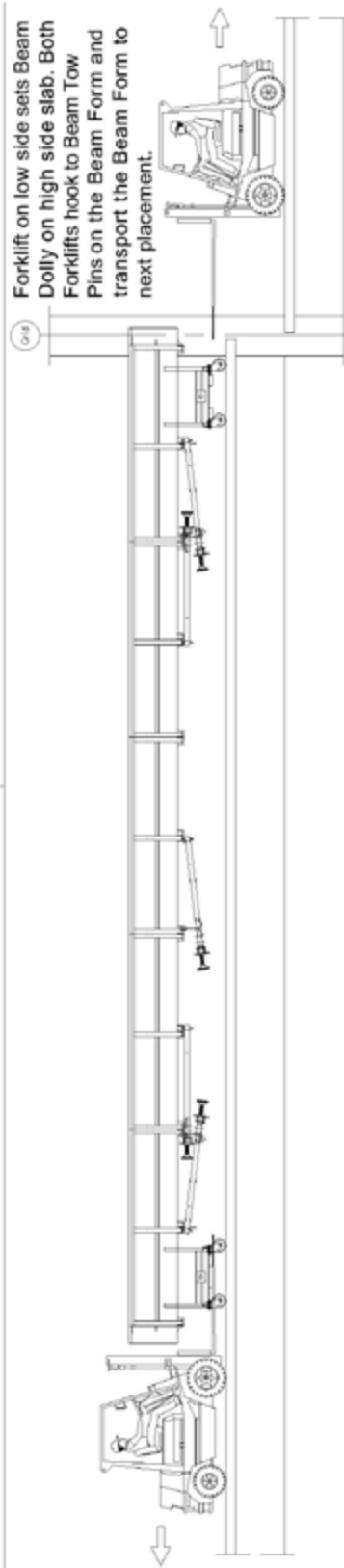
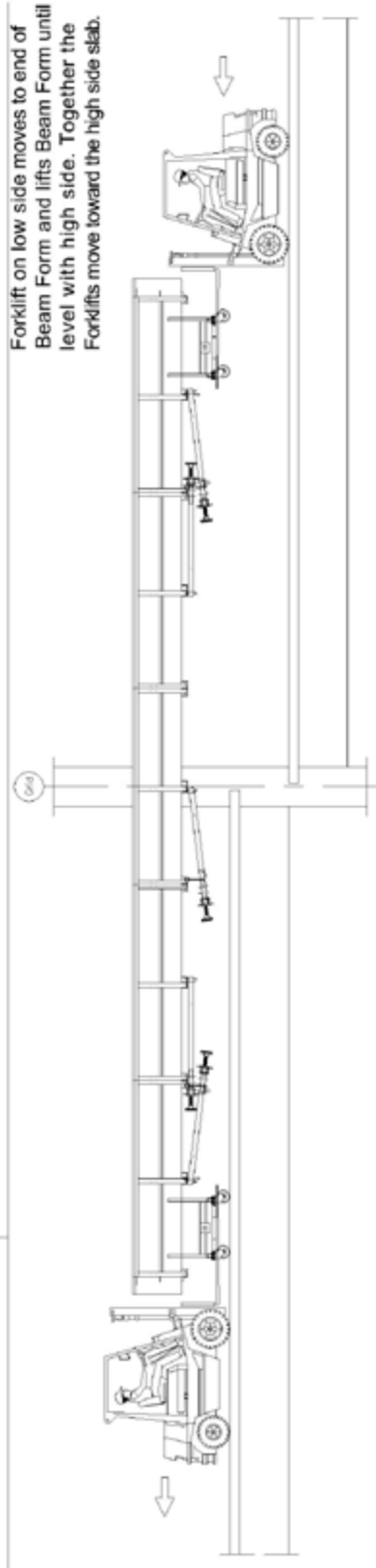

## Transporting the Beam through the Ramp Cross-Over

TYPICAL FIELD  
DETAIL DRAWINGS

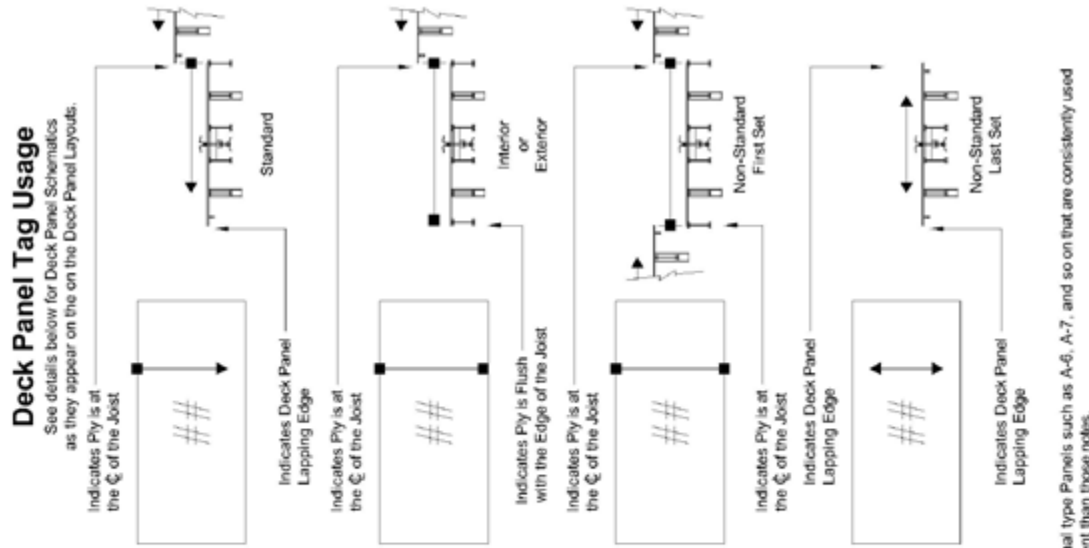

**Deck Panel Tag Usage**  
See details below for Deck Panel Schematics as they appear on the on the Deck Panel Layouts.

**Standard Interior Deck Panel:** Panel Width = 8'-0"  
Panel Length = Varies by the Beam Width and the Bay Width  
Joist Length = Varies by the Panel Length and the GBS System being used

**Additional Deck Panel A-1 Notes:** Use Deck Panel Tags such as A-1L or A-1R in such an application as when a Chamfered Deck Panel must be Notched to fit around a Column or a Wall and remains as such for the duration, if this is a one-time thing, then the Deck Panel should be replaced by Hand-Set.

**Chamfered Interior Deck Panel:** Panel Width = 8'-0"  
Panel Length = Varies by the Beam Width and the Bay Width  
Joist Length = Varies by the Panel Length and the GBS System being used  
Same as a Standard Interior Deck Panel, but with a Chamfered Leading Edge for use against adjacent Walls or Transfer Girders

**Additional Deck Panel A-1C Notes:** Use Deck Panel Tags such as A-1CL or A-1CR in such an application as when a Standard Deck Panel must be Notched to fit around a Column or a Wall and remains as such for the duration, if this is a one-time thing, then the Deck Panel should be replaced by Hand-Set.

**Exterior Deck Panel:** Panel Width = 8'-0"  
Panel Length = Varies by the Beam Width and the Bay Width  
Joist Length = Varies by the Panel Length and the GBS System being used (some Joists may need to be cut shorter between the Exterior notches)  
Notch Width = Varies by the Beam Width and the Column Size  
Notch Length = Varies by the Column Size, hold minimum 30" outside

**Additional A-2 Deck Panel Notes:** Use Deck Panel Tags such as A-2L or A-2R in such an application as when an Exterior Deck Panel is Notched for a different Column size on each side.

**Interior Deck Panel (Typically used at the Interior Ramp Separation):** Panel Width = 8'-0"  
Panel Length = Varies by the Beam Width and the Bay Width  
Joist Length = Varies by the Panel Length and the GBS System being used (a Joist or two may need to be cut shorter between the interior notches)  
Notch Width = Varies by the Beam Width and the Column Size  
Notch Length = Varies by the Column Size and by how far the Separated Slabs cut into the sides of the Columns. An extra 1/2" is added for an Edge Deck lip

**Additional A-3 Deck Panel Notes:** Use Deck Panel Tags such as A-3L or A-3R in such an application as when an Interior Deck Panel is Notched for a different Column size on each side.

**Standard (4 Joists) Filler Deck Panel:**  
Panel Width = 6'-4 1/2"  
Panel Length = Varies by the Beam Width and the Bay Width  
Joist Length = Varies by the Panel Length and the GBS System being used

**Similar to a Standard Interior Deck Panel, but reduced Width by one (1) Joist (this is for a 19'2" O.C., joists spacing, other Joists spacing's will vary)**

**Standard (3 Joists) Filler Deck Panel:**  
Panel Width = 4'-9 1/2"  
Panel Length = Varies by the Beam Width and the Bay Width  
Joist Length = Varies by the Panel Length and the GBS System being used

**Similar to a Standard Interior Deck Panel, but reduced Width by two (2) Joists (this is for a 19'2" O.C., joists spacing, other Joists spacing's will vary)**

**Standard Joists Number Reference for all Deck Panels =**  
4 for 24" O.C., 5 for 19'2" O.C., 6 for 16" O.C. and 7 for 12" O.C.

Anything smaller than a three (3) Joists Panel will be Hand-Set By Contractor

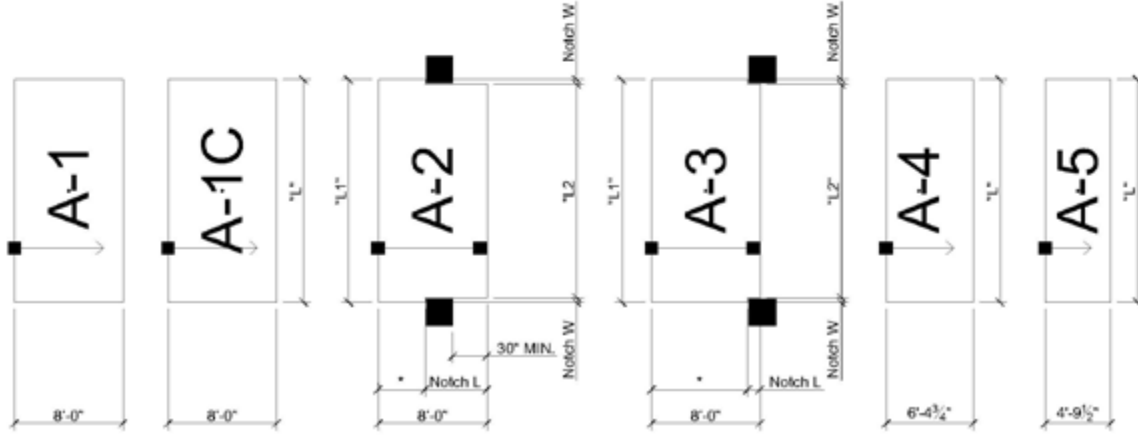

All Deck Panels are designed to utilize a 1" gap form the Beam Form, from the Column Capital and around all Notches.

## Deck Panel Reference and Schematic Details

Additional Information:  
One (1) Deck Panel Bolt (Centered in length) per Deck Panel for Bays up to 20'-0"  
Two (2) Deck Panel Bolts (at the quarter points) per Deck Panel for Bays greater than 20'-0"  
This is for Reference Only. See Individual Deck Panel Assembly Drawings for all types of Deck Panels required per Job.

Make additional type Panels such as A-6, A-7, and so on that are consistently used but are different than those notes.

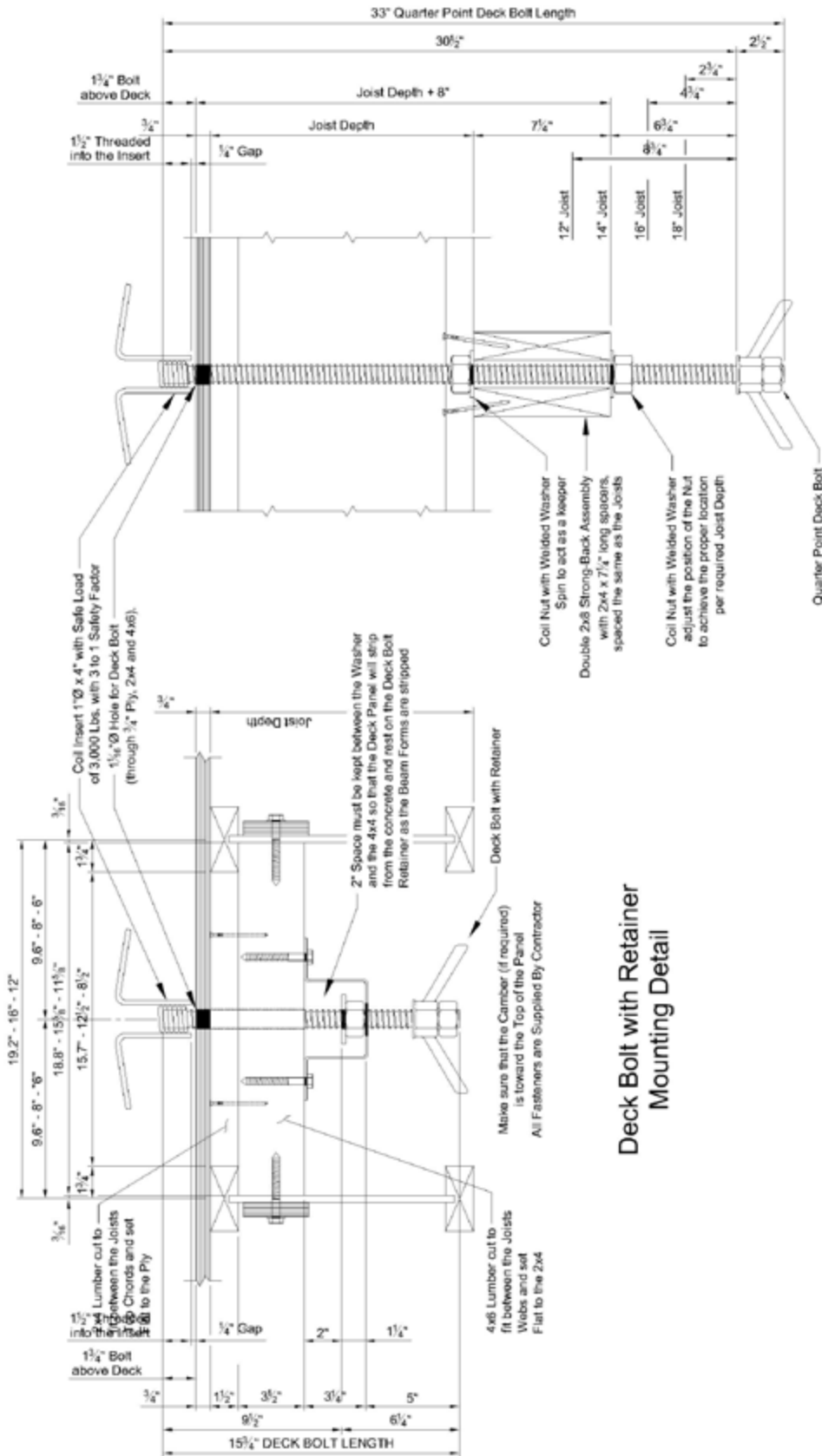

**Typical Deck Panel Deck Bolt and Quarter Point Deck Bolt Details**

TYPICAL FIELD  
DETAIL DRAWINGS



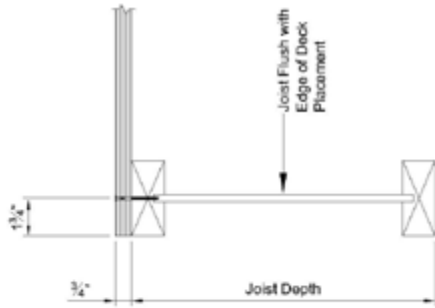

Typical Joist Flush with Edge of Ply Detail

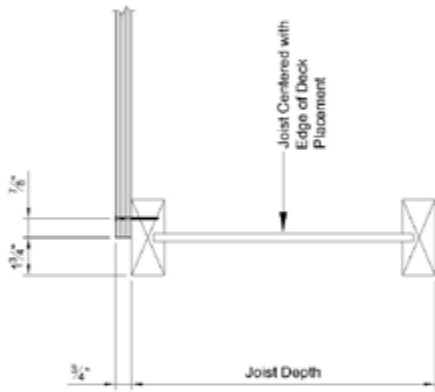

Typical Joist Centered with Edge of Ply Detail

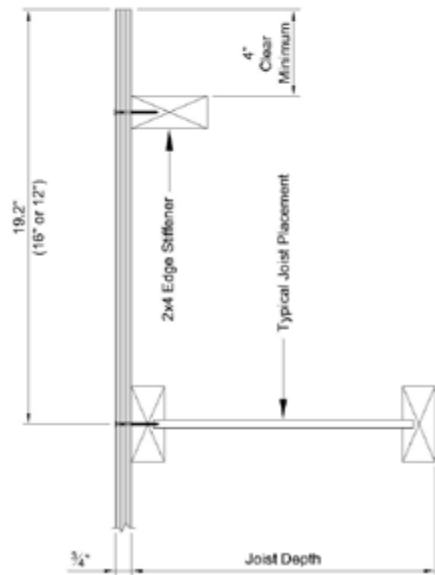

Typical Joist and 2x4 Edge Stiffener Detail

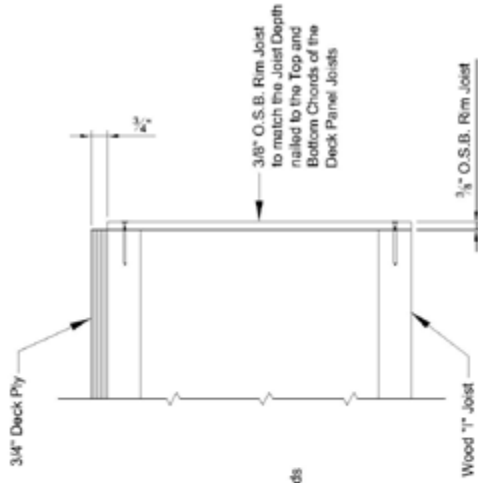

Typical Deck Panel Ply and Rim Joist Detail with Ply Flush with the End of the Joist

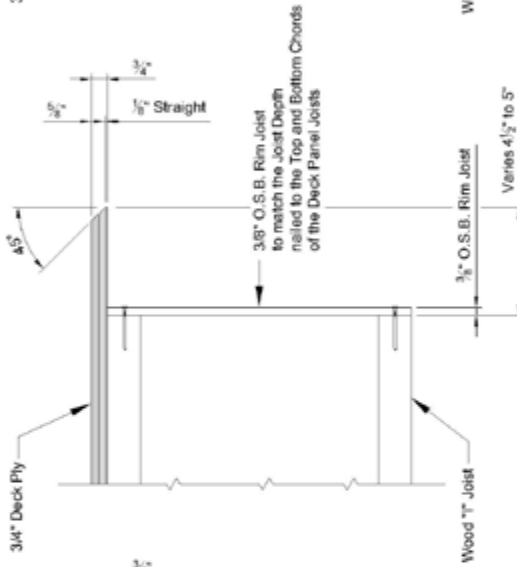

See Dimension "C" on the individual Deck Panel Drawings for actual Dimension  
Typical Deck Panel Ply Over-Hang and Rim Joist Detail as used on the Ledger System

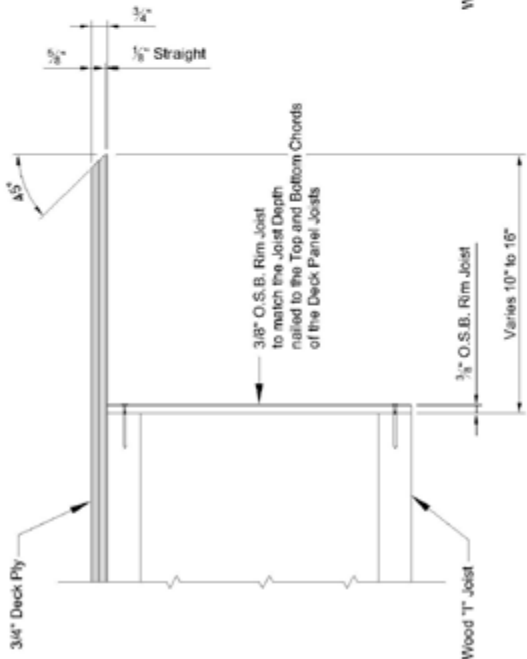

See Dimension "C" on the individual Deck Panel Drawings for actual Dimension  
Typical Deck Panel Ply Over-Hang and Rim Joist Detail as used on the Top Jack System

## Typical Deck Panel Plywood Over-Hang and Edge Details

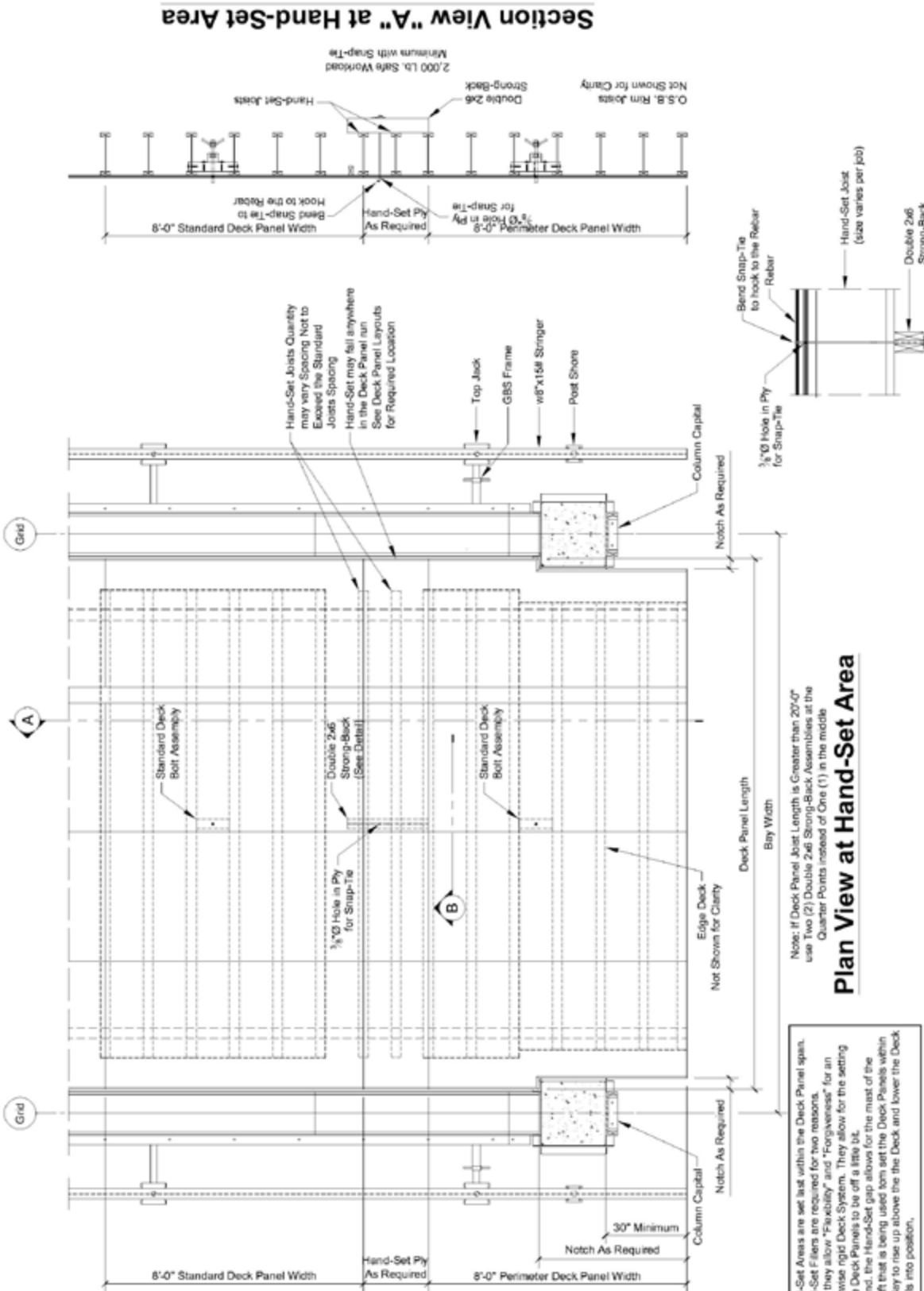

**Section View "B" at Hand-Set Area**  
**Typical Deck Panel Hand-Set Detail**

Hand-Set Areas are set last within the Deck Panel span. Hand-Set Fillers are required for two reasons. First, they allow "Flexibility" and "Forgiveness" for an otherwise rigid Deck System. They allow for the setting of the Deck Panels to be off a little bit. Second, the Hand-Set gap allows for the most of the Forklift that is being used to set the Deck Panels within the Bay to rise up above the Deck and lower the Deck Panels into position.

Double 2x6 Strong-Back and Snap-Tie will Secure the Hand-Set Decking to the Bottom of the Slab after the Support has been stripped away. For further Hand-Set Information and Details See Sheet "D-2.11" in the Deck Panel Standards

TYPICAL FIELD  
DETAIL DRAWINGS

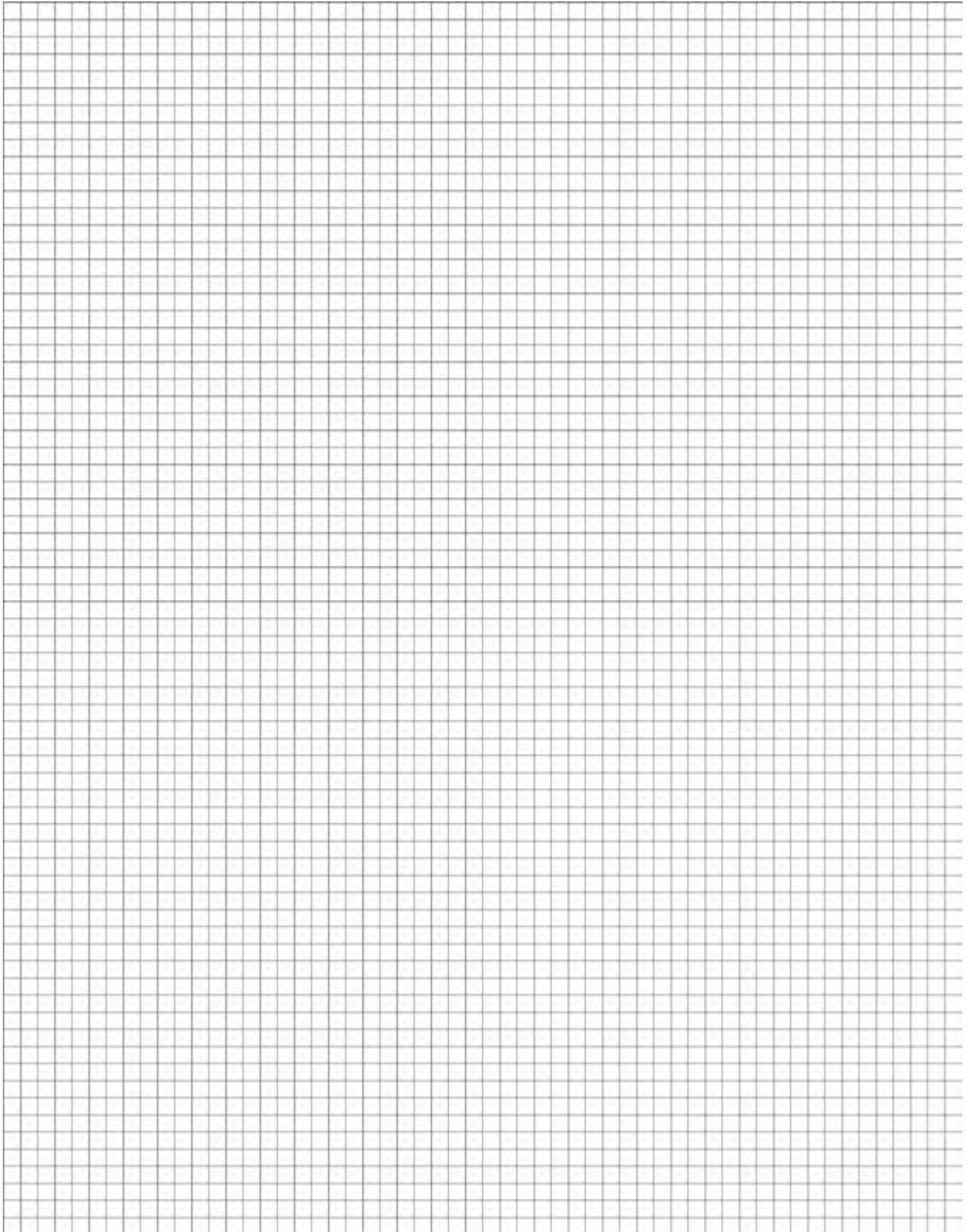

## Crew Designations

On a Typical Parking Garage, the crews in the following procedures consist of two (2) men each. For Setting and Stripping the Beam Assemblies, you will need to designate labor for the following:

1. Prep Crew: Stages and Cleans the Stripping Area, the Transport path and the Setting Area.
2. Strip Crew: Strips the Beam Assemblies from their present location and helps load the Beam Assemblies into the Beam Dollies for Transportation.
3. Transport Crew: Two (2) Forklifts and operators to haul the Beam Assemblies to their next use location.
4. Set/Grading Crew: First have all of the Capitals for the required area set in place and graded on the Columns. Second, as the Beam Assemblies arrive in location, they are lifted by the Forklifts and set into the awaiting Capitals. The Set Crew then goes to work dropping the Frames and setting the Bottom Jacks, as required. Grading the System (not necessary on the Ledger System and only micro adjustments are required on either the Header/Top Jack System and the 50 Kip System) After the Beam Assembly is set into position, the Stringers to their required height to be ready to receive the Deck Panels. This is done by adjusting the Top Jacks up or down as required.

Note that the same crew is responsible for the Capital and Ramp Capital Assemblies which are stripped the day after the pour and immediately move to the location of their next use where they are re-set, as required.

For Setting and Stripping the Deck Panels and Hand-Sets, you will need to designate labor for the following:

1. Strip Crew: Using the Stripping Truss, the Strip Crew strips the Deck Panels from their present location and helps load the Deck Panel Dollies for Transportation.
2. Cleaning and Oiling Crew: Clean and Oil the Deck panels as they are stripped, before they are Transported to the required area. This is important so that the Deck Panels may be set directly into place as soon as they arrive in the area.
3. Transport Crew/Stock: One (1) Forklift and operator and one Laborer will haul the Deck Panels to their next use location. They also haul the Deck Panels that are not required to an out of the way location or they will gather any additionally required Deck Panels. They will also handle any Hand-Set conditions, as far as getting it from one area to the next.
4. Set Crew: Along with the Forklift operator, the Set Crew will help align and set all Deck Panels and Hand-Set as it comes into position.

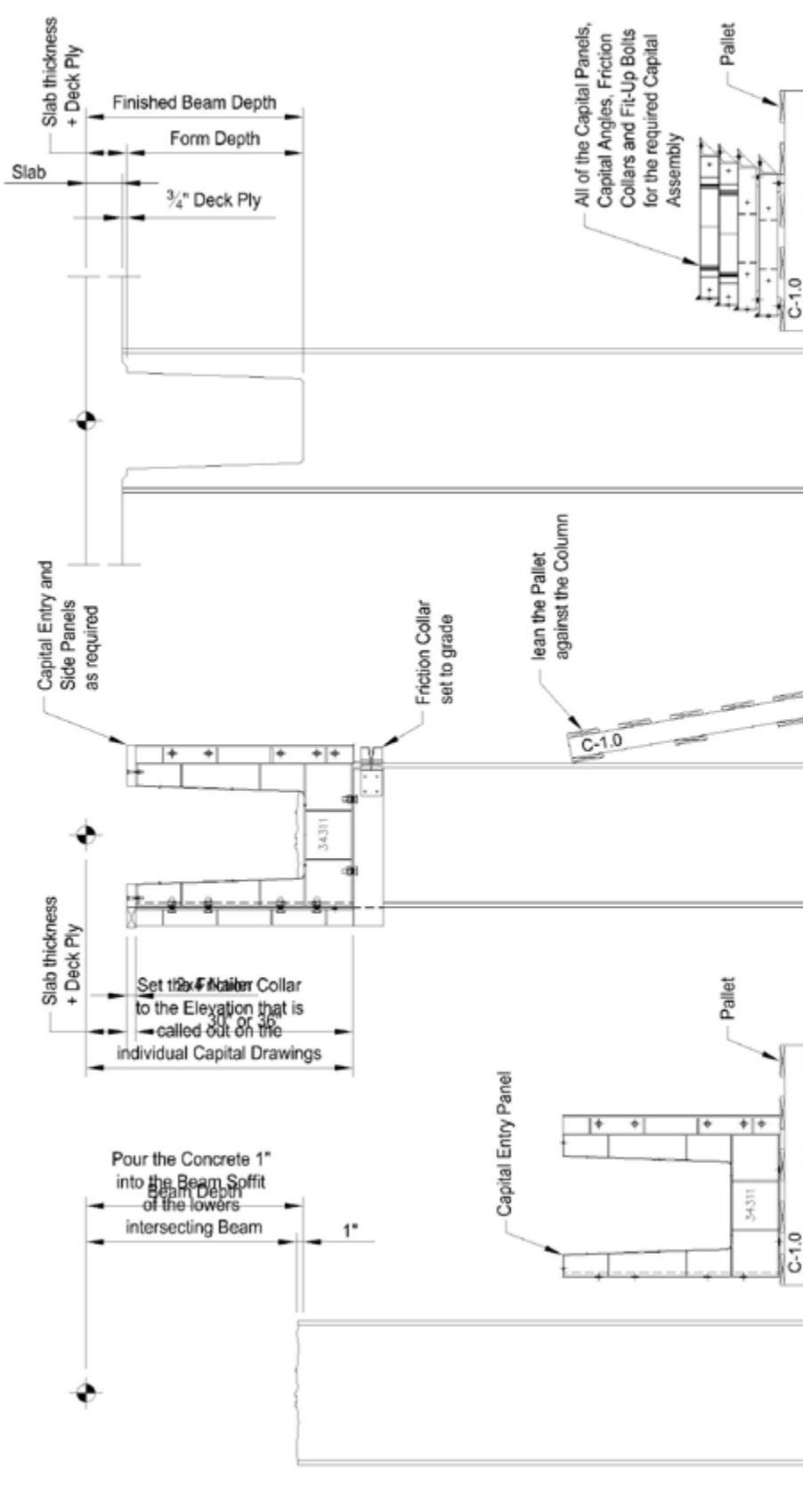

**FIRST USE ON JOB**

Do a trial assembly on each Column Capital to assure proper assembly of all of the Panels, as per Drawings



Label each pallet with its appropriate designation number according to the Capital Assembly Details.

**DURING USE**

Keep the appropriate pallet near by but clear from obstructing anything

**AFTER POUR**

Disassemble the Capital and place all of the Panels and parts on the appropriate pallet and transport to the location of the next use

**Capital Marking Procedures**



There should be a separate pallet for each of the Capital Assemblies required on the job (See the supplied Capital Assembly Drawings, C-XX Series). All of the parts that make up each of the Capital Assemblies should be included on that particular pallet, this includes: Friction Collar halves, Steel Capital Entry Panels, Steel Capital Side Panels, Steel Soffit Support Panels, Capital Bolt-On Angles, Capital Offset Angles and all of the required Fit-Up Bolts.



For Capital Assemblies that are used on the Perimeter, It is a good idea to have a few extra 3/4" Plywood Stressing Backs on the Pallet so that they do not have to be cut each time, as they are often ruined during the stripping procedure. The 2x4 Nailers should be pre-attached all of the Panels as required.



Each Pallet should be neatly marked to clearly identify the individual Capital Assembly (See Page E-2 for additional information).

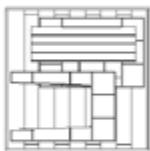

Pallet with a individually marked Capital Assembly on it that is being transported by the Forklift to be dropped off next to the required Column location

Forklift

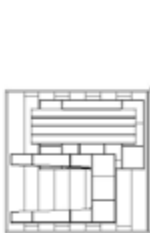

Pallets with individually marked Capital Assemblies at each Column location (See supplied Capital Assembly Placement Layout Drawings for actual Grid locations)

Columns poured 1" into the Beam Soffit, Typical (See Page E-2)



SETTING AND STRIPPING PROCEDURES

(A) Transport Crew transporting pallets with individual Capital Assemblies on them from either the initial Build-Up Area or from the previous use Stripping Area.

## Transporting the Capital Assemblies

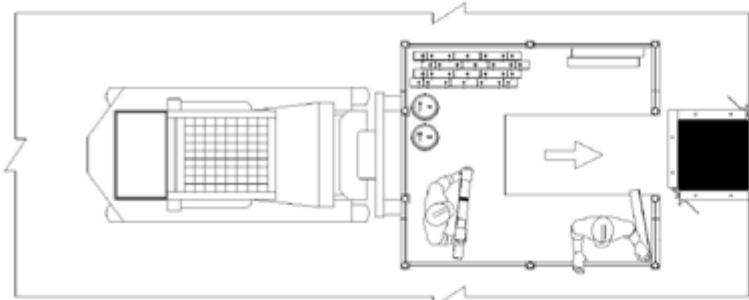

- (B) 1. The Grading Crew members gather the pallet for the required Capital Assembly and unload the components and required tools onto the Capital Assess Work Deck.
2. Then move the empty pallet out of the way. The Capital Access Work Deck has all of the safety hand-rails in place except for the one directly adjacent to the Column.

Two Grade Crew members and all of the Capital Components required to assemble the designated Capital Assembly (See Page E-2)

Forklift

Friction Collar Set to Grade (See Page E-2)

Column poured 1" into the Beam Soffit (See Page E-2)

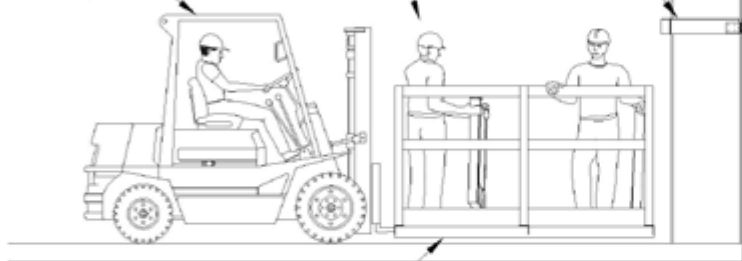

Capital Access Work Deck

- (C) 3. The Forklift engages the Capital Assess Work Deck and the Grade Crew members get onboard.
4. The Forklift then moves forward to wrap around the Column.
5. The Grade Crew members then secure the exterior safety hand-rail.

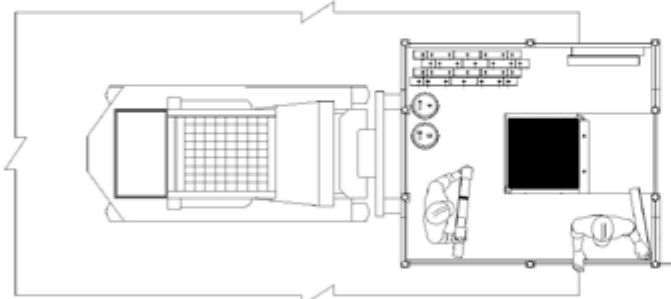

- (D) 6. The Forklift then raises the Capital Assess Work Deck to a comfortable height, just a few inches below the Friction Collar.

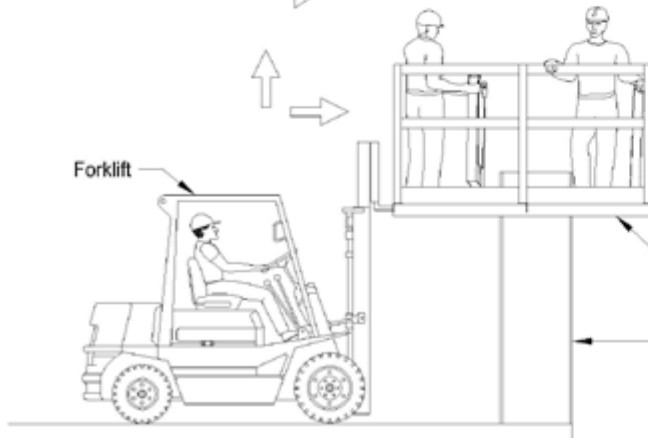

Capital Access Work Deck

Column poured 1" into the Beam Soffit (See Page E-2)

## Capital Assembly Setting Procedures

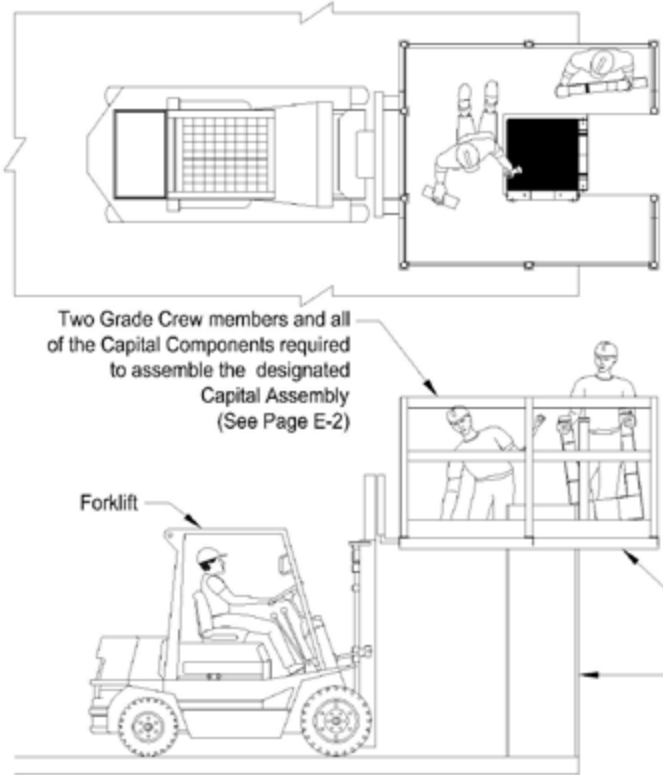

(E) 7. With the Capital Assess Work Deck held stationary by the Forklift, the Grade Crew members can then start to assemble the designated Capital as per the Capital Assembly Drawings.

8. Make sure that the entire Capital is complete before disengaging, including bolting up all of the Steel Panels, the Capital Angles and the Friction Collar. Add on all 2x4 Nailers and top Build-Ups when required (see page C-24). Add in the Plywood and 2x4 blocking for the Stressing Back when required.

Two Grade Crew members and all of the Capital Components required to assemble the designated Capital Assembly (See Page E-2)

Capital Access Work Deck

Column poured 1\"/>

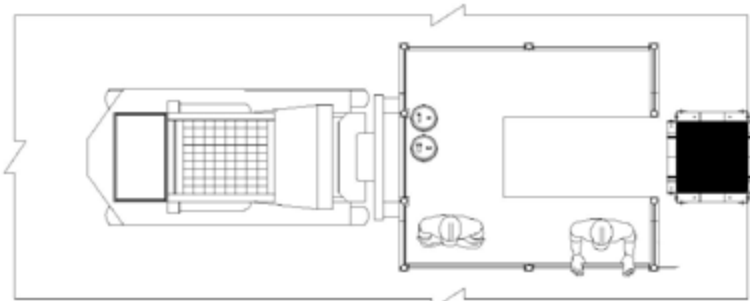

(F) 9. After the Capital is 100% complete, the Grade Crew members can remove the exterior safety hand rail and step away from the opening.

10. The Forklift then backs out away from the column and slowly lowers the Capital Assess Work Deck and the Grade Crew members safely to the ground.

11. Proceed to each column in the pour and set those Capital Assemblies as well.

Capital Access Work Deck and Two Grade Crew members lowered safely to the ground

Completed Capital Assembly

Forklift

Column

### Capital Assembly Setting Procedures

SETTING AND STRIPPING PROCEDURES



## Capital Stripping Procedures

- A. The Capital and Ramp Capitals should be stripped the Day After the Pour
1. Remove the Capital Assemblies and Friction Collars completely and place all of the parts onto individually marked Pallets (See Page E-2).
  2. Transport the Capital Assembly Pallets immediately to the location of their next required use (See Page E-3).
  3. The columns in the next designated area should already be in place and the Capital Assemblies should be put right back up as soon as possible (See Pages E-4 and E-5).
  4. Note that having the pathway between the stripping area and the setting area clean and clear of all debris is essential to transporting the Capital Assemblies quickly and efficiently.

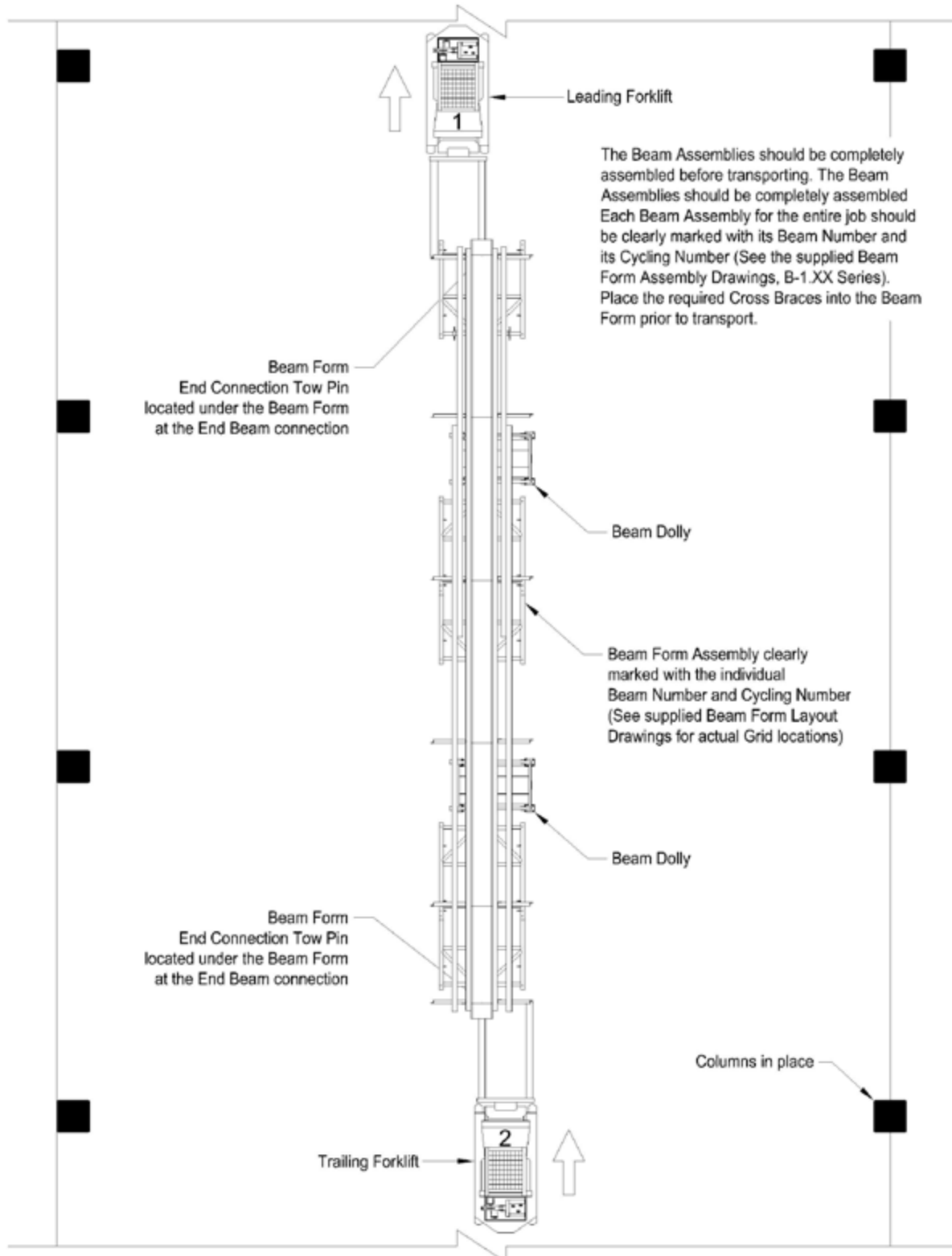

SETTING AND STRIPPING PROCEDURES

(A) Transport Crew transporting a Beam Form Assembly from either the initial Build-Up Area or from the previous use Stripping Area.

## Transporting the Beam Form Assemblies

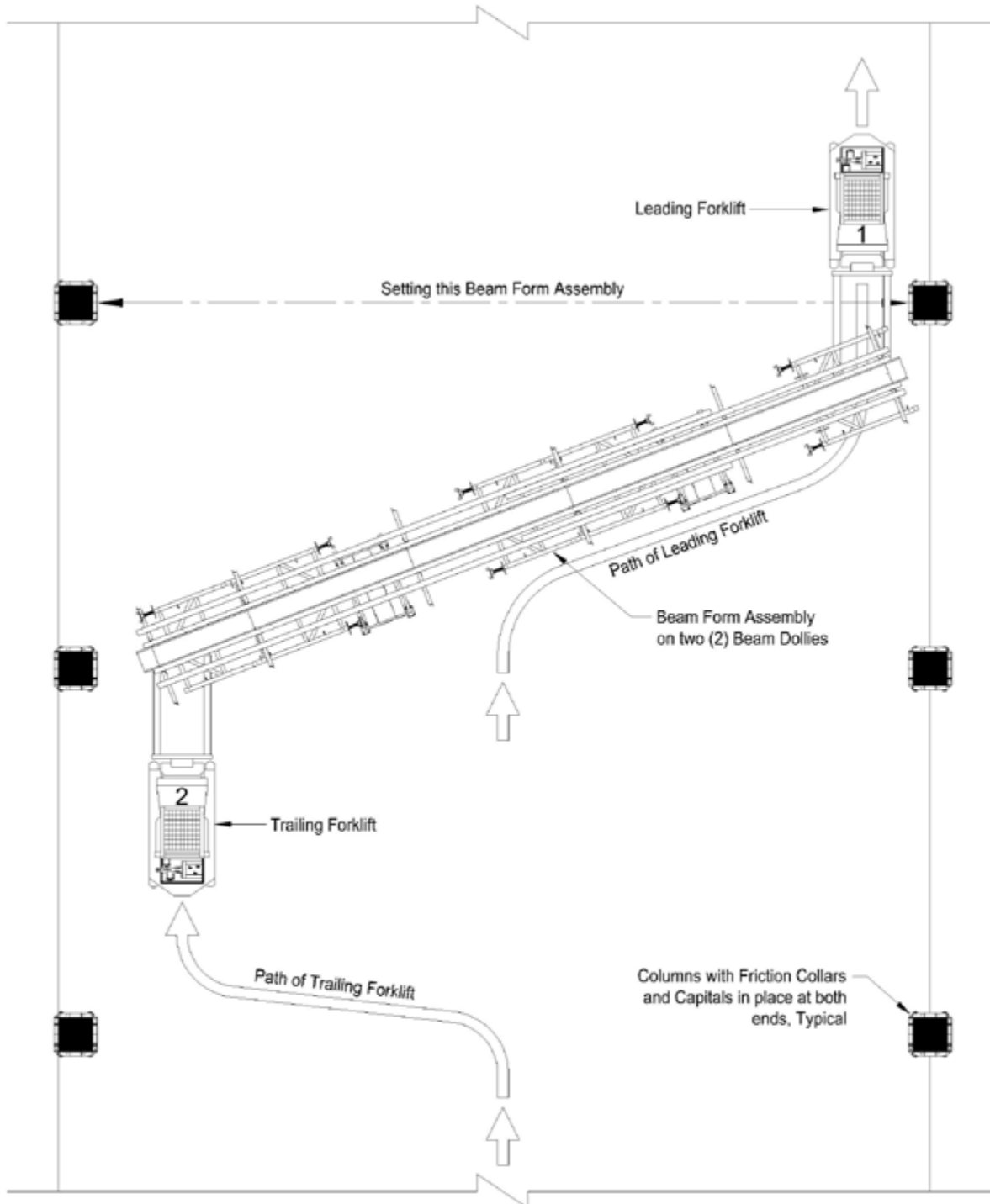

(B) Transport Crew making initial turn to set up the Beam Form.

## Beam Form Setting Procedures 1

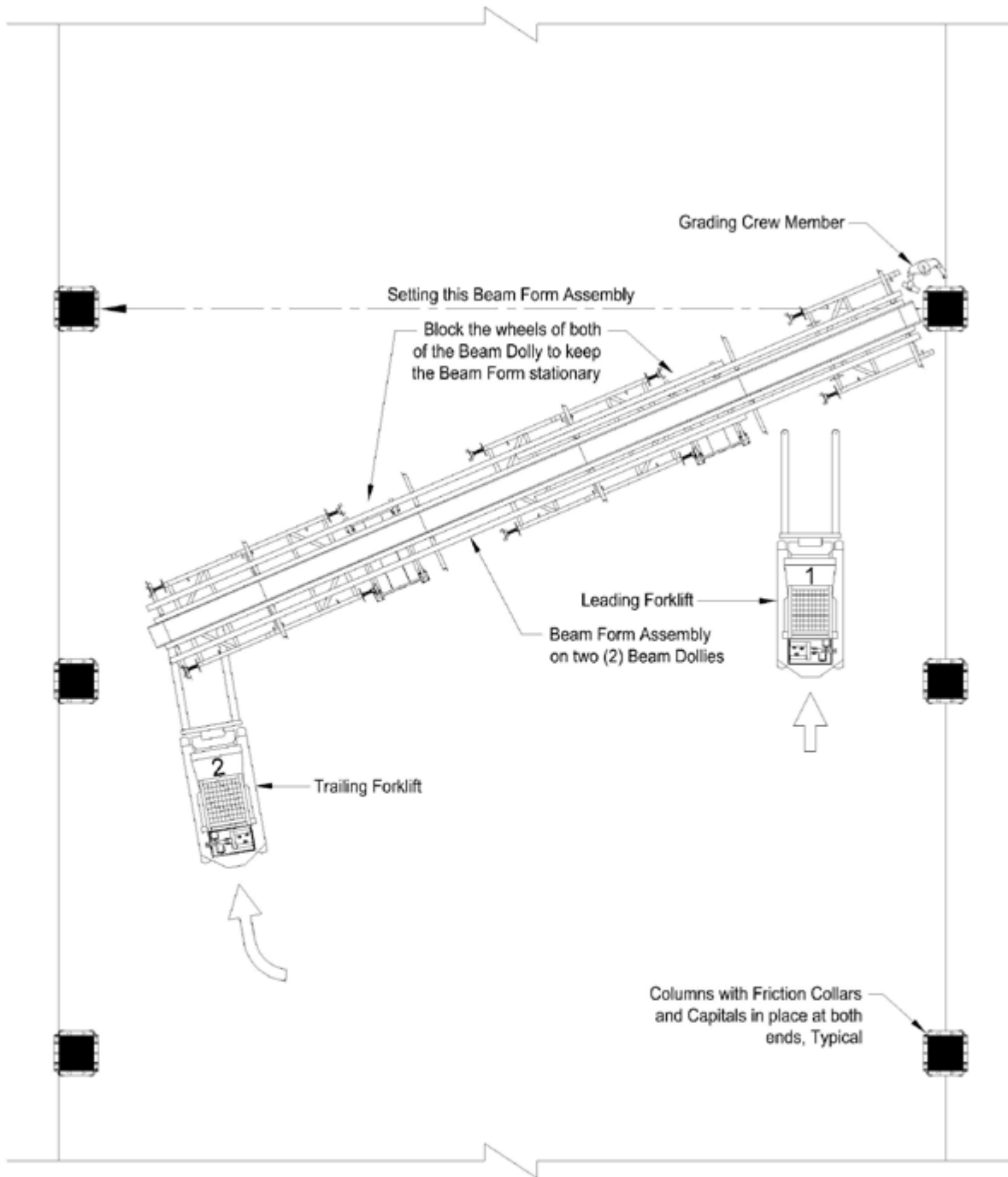

SETTING AND STRIPPING PROCEDURES

- (C) Forklift No. 1 disengages from the Beam Form and moves to the same side of the Beam Form as Forklift No. 2. Block the wheel of the Beam Dollies to keep the Beam Form stationary.
- (D) A Grading Crew member holds a scrap piece of lumber against the for the End of the Beam Form to index against.

## Beam Form Setting Procedures 2

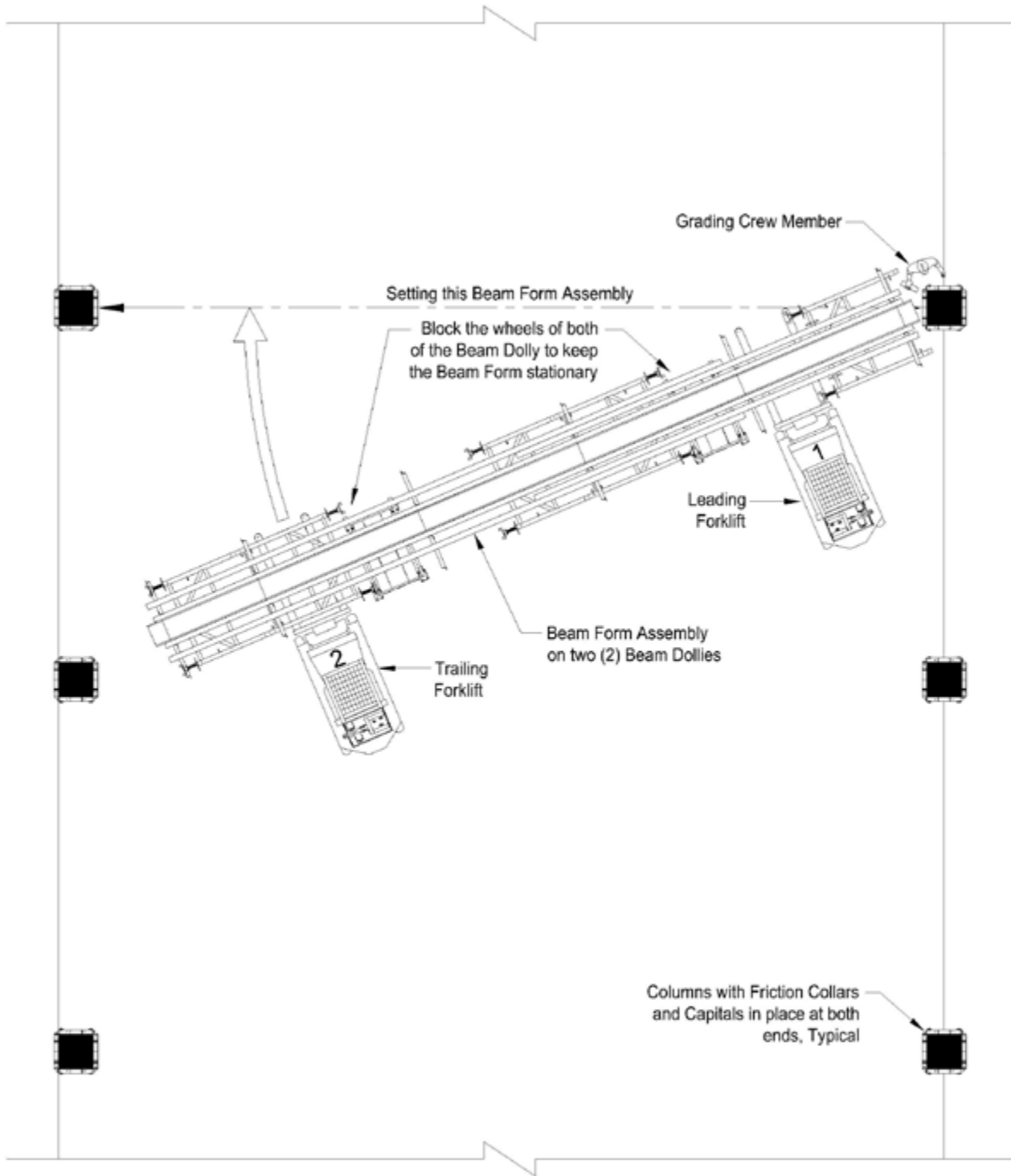

(E) Forklift No. 1 moves under the Beam Form. Forklift No. 2 disengages and also moves under the Beam Form, as shown (Do Not engage the Beam Dollies).

(F) Together both Forklifts swing the Beam Form into position between the Columns.

### Beam Form Setting Procedures 3

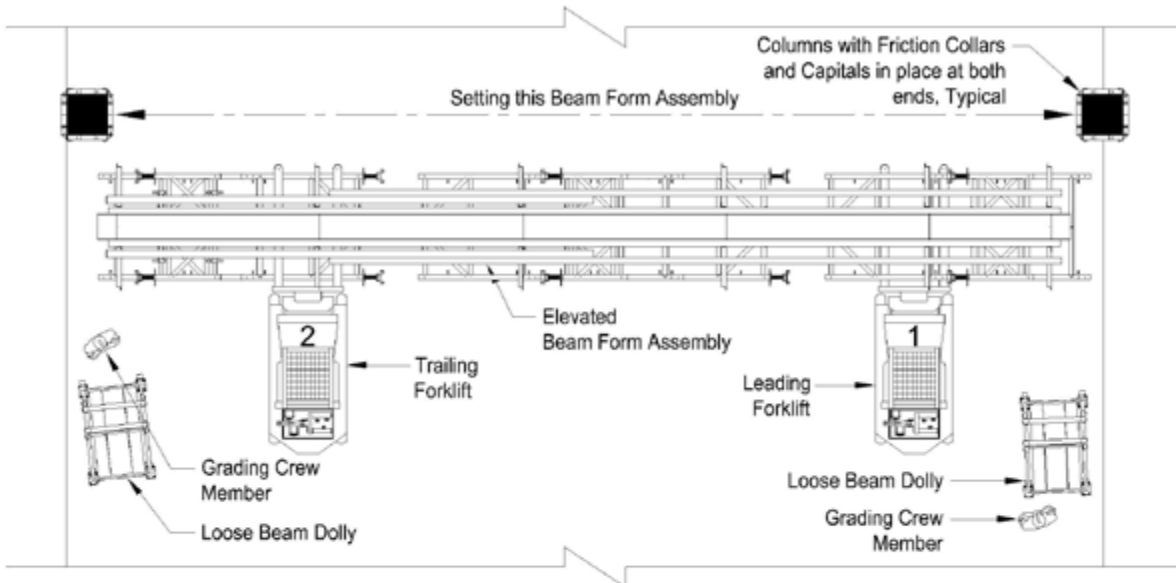

(G) Together, both Forklifts back up far enough for the Beam Form to clear the Capitals and then raise it to shoulder height. The Grading Crew moves Beam Dollies aside for the return trip.

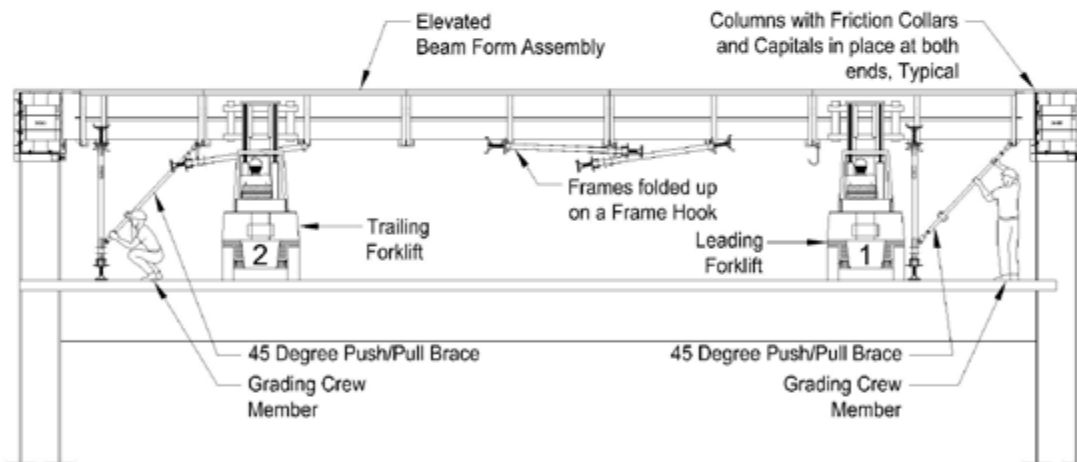

(H) The Grading Crew members drop end Frames and motion the Forklifts to raise Beam Form until the Frames hang plumb. Grading Crew then attaches Push-Pull Braces to both ends.

## Beam Form Setting Procedures 4

SETTING AND STRIPPING PROCEDURES

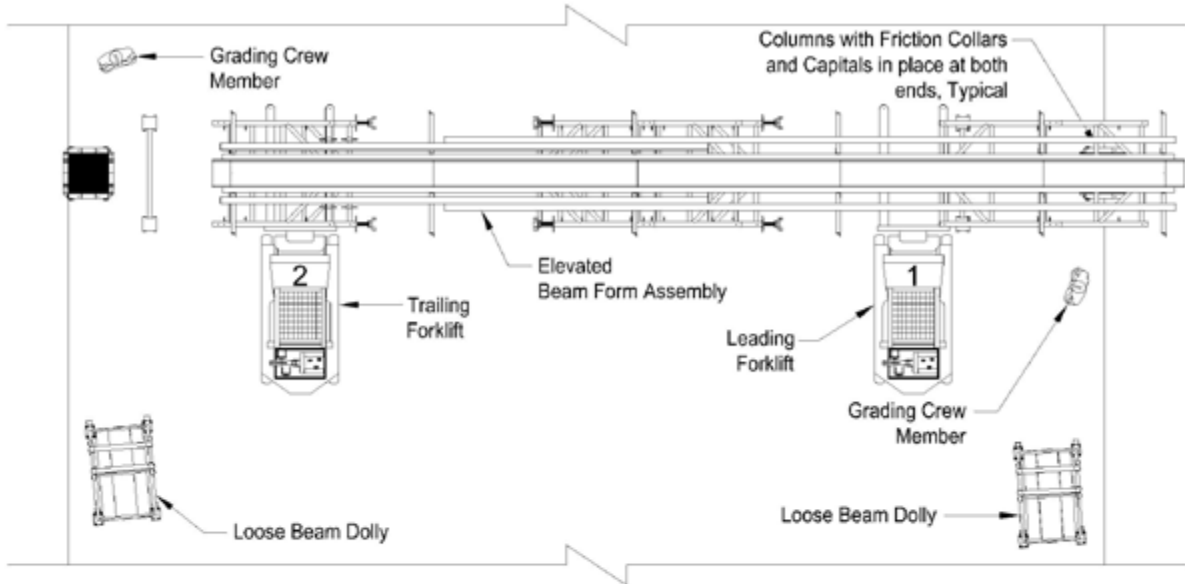

- (I) Together both Forklifts raise the Beam Form to clear the top of the Capitals, then move forward until the Beam Form is centered on the Grid Line, over the Capitals. The Grading Crew members on the ground help to sight and direct this operation.

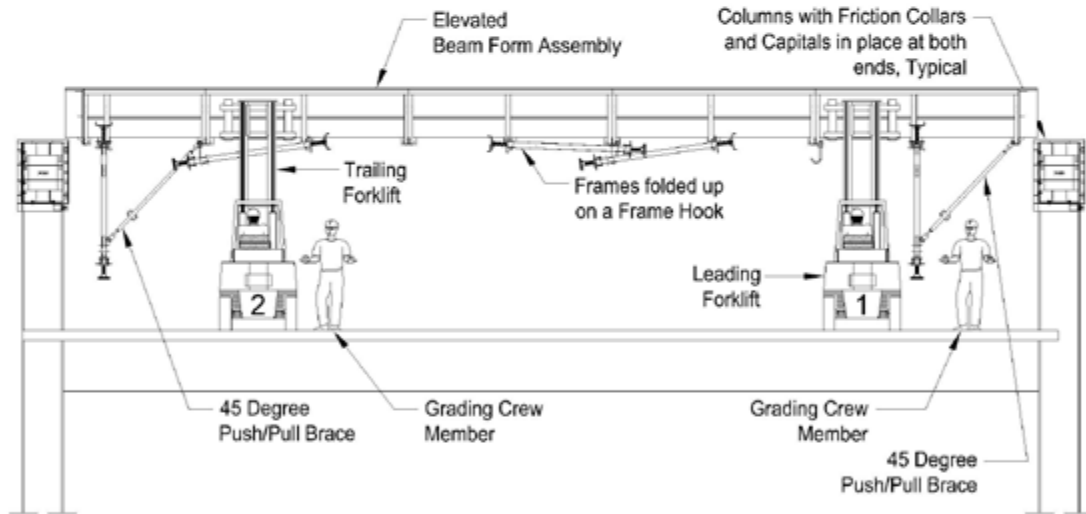

- (J) Using the mast tilt, both Forklifts level the Beam Form by lining up the vertical frame legs with the Column. With the two Grading Crew members directing the operation, lower the Beam Form into the Capital. Stop the Beam approximately  $\frac{1}{2}$ " from seating into the Capital.

## Beam Form Setting Procedures 5

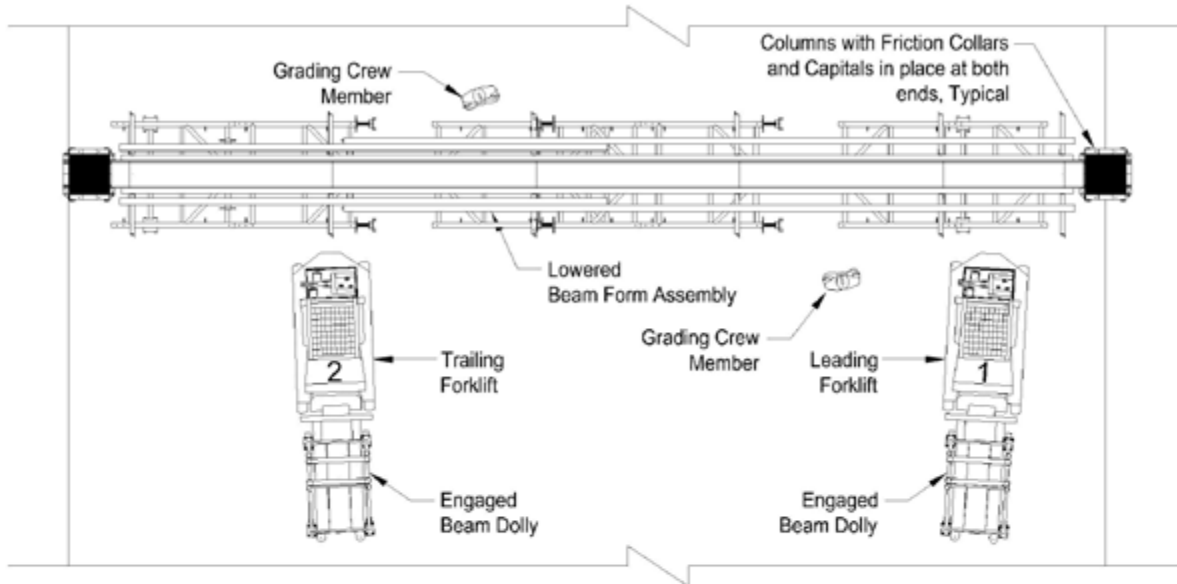

(K) The Grading Crew members then lower the Bottom Jacks of the end Frames to the slab. The Forklifts disengage the Beam Form, pick up the Beam Dollies and return to the Build-Up Area or to the Stripping Area to collect the next Beam Form that is to be transported.

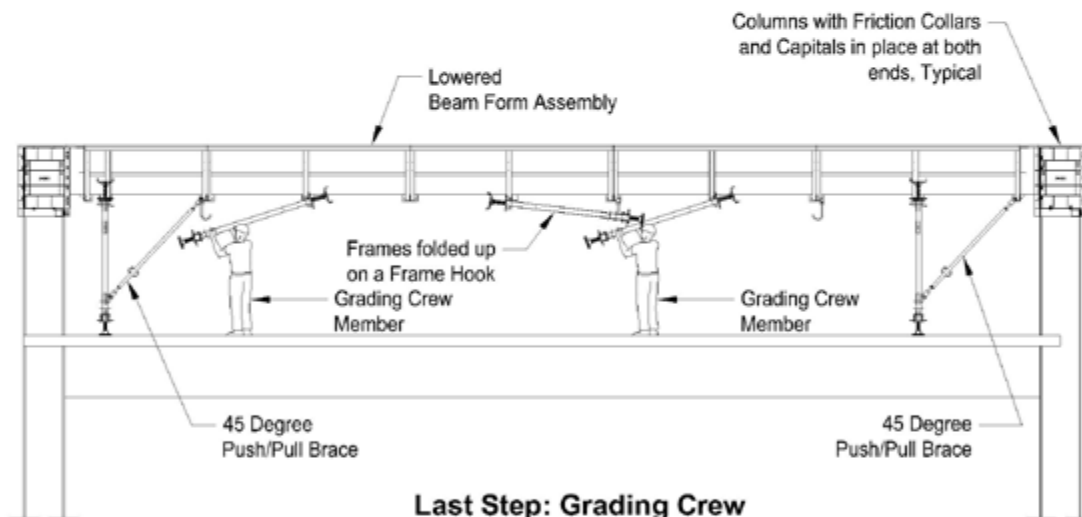

**Last Step: Grading Crew**

- (L) The Grading Crew members then finish setting the Beam Form by doing the following:
1. Lower the remaining Frames
  2. Put on the Cross Braces.
  3. On the Center-Load Frames, run the Bottom Jacks down to the slab and level center of the Beam Form.
  4. String the side of the Beam Form and adjust the screw on Center-Load Frames if required.
  5. Run the Bottom Jacks on the remaining Frames to the slab.
  6. Set the Grading Template (See Page C-48) over Beam Form and grade the Top Jacks (Not required on the Ledger System and only fine adjustments are required on the Header/Top Jack System and the 50 Kip System).

SETTING AND STRIPPING PROCEDURES

**Beam Form Setting Procedures 6**



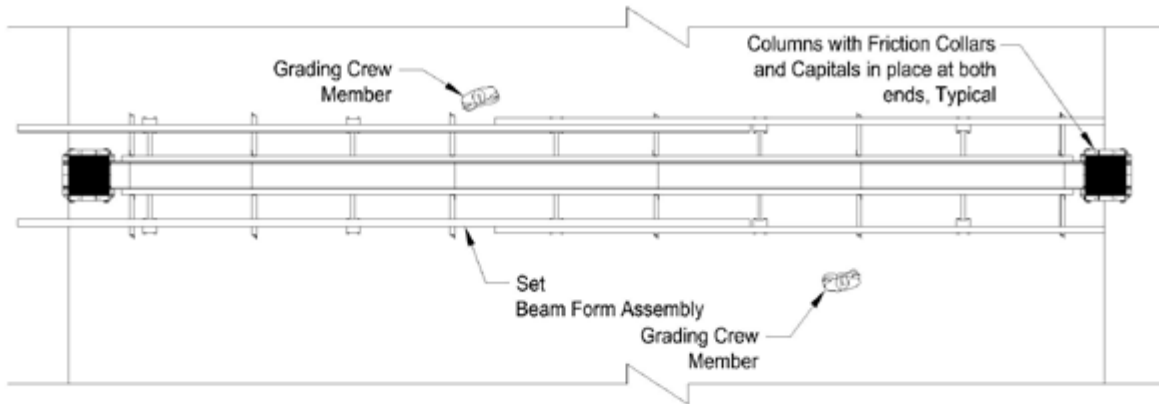

- (M) The Grading Crew members remove the Stringers from the Stringer Support Arms, position them on top of the Top Jacks and loosely secure in place with the Safety Steel Friction Clamps and the Steel Beam Clamps.
- \* Not required on the Ledger System, as the Ledger System Stringers are always Beam Clipped directly to the Ledger Brackets and always remain stationary, therefore, Post Shores must be used to collect any unsupported Deck.

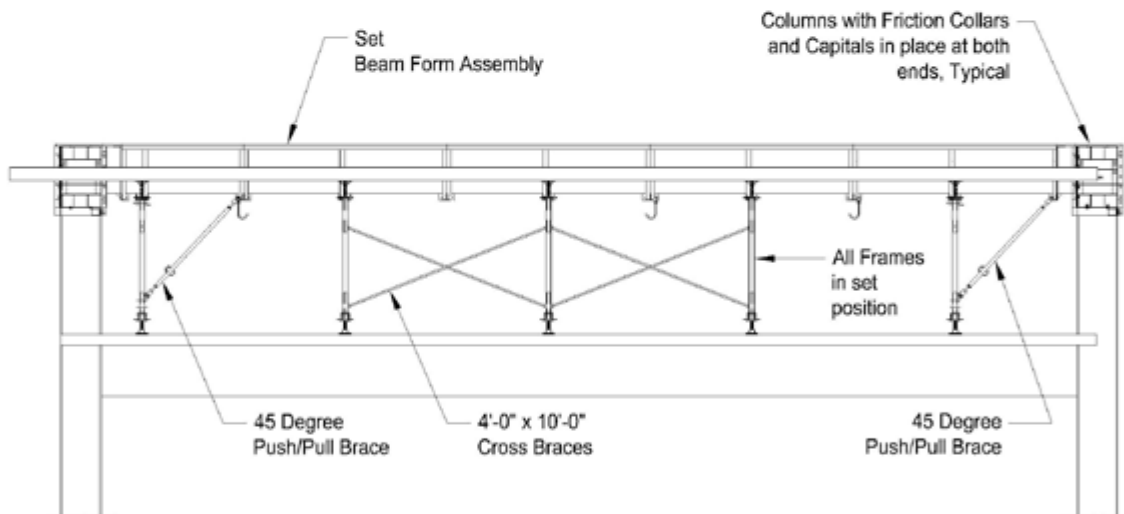

**Completed Beam Form Elevation**

- (N) The Grading Crew members then loosen the Safety Steel Friction Clamps and the Steel Beam Clamps on the Top Jacks, but Do Not remove them, they then slide the Stringers outward on the Top Jacks to their required position alongside the Beam Form, they then re-tighten all of the Safety Fasteners again.
- (O) Any Stringer that cantilevers greater than 3'-0" must be Post Shored!
- (P) Go to the next Beam Form and repeat these procedures.

**Beam Form Setting Procedures 7**

(Q) The Transportation and Setting Procedures for a Transfer Girder is similar to that of Transporting and Setting a standard Beam Form (See Pages E-6, E-7, E8, E-9, E-10, E-11 and E-12).

- Since a Transfer Girder essentially replaces a Column, a Transfer Girders must be set after the Column Capitals and before the Beam Forms, because the crossing Beam Forms set into the middle of the Transfer Girder as if it were a Capital.

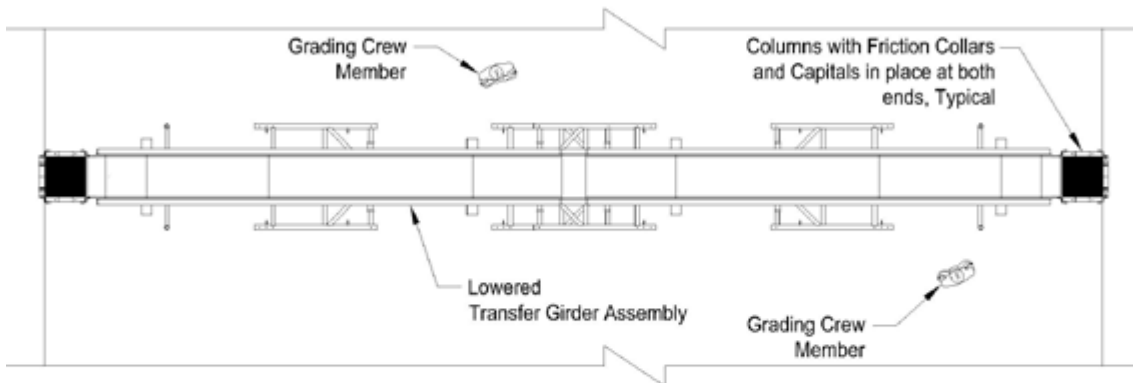

(R) The Grading Crew members then lower the Bottom Jacks of the end Frames to the slab. The Forklifts disengage the Transfer Girder, pick up the Beam Dollies and return to the Build-Up Area or to the Stripping Area to collect the next Beam Form that is to be transported.

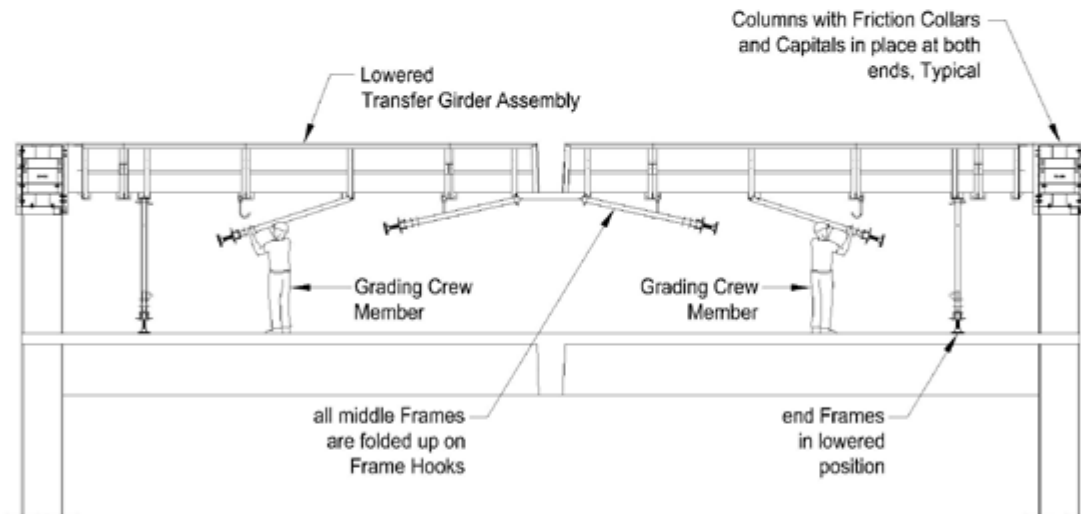

### Last Step: Grading Crew

(S) The Grading Crew members then finish setting the Transfer Girder by doing the following:

1. Lower the remaining Frames
2. Put on the Cross Braces.
3. On the Center-Load Frames, run the Bottom Jacks down to the slab and level center of the Beam Form.
4. String the side of the Beam Form and adjust the screw on Center-Load Frames if required.
5. Run the Bottom Jacks on the remaining Frames to the slab.

## Transfer Girder Setting Procedures 1

SETTING AND STRIPPING PROCEDURES

- Since a Transfer Girder essentially replaces a Column, a Transfer Girders must be set after the Column Capitals and before the Beam Forms because the Beam Forms set into the middle of the Transfer Girder as if it were a Capital.

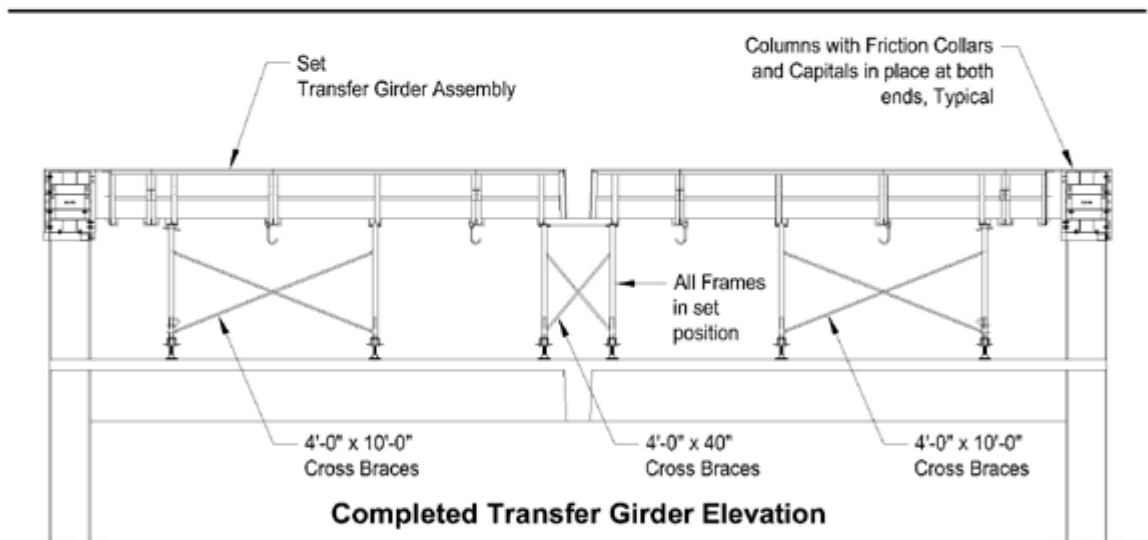
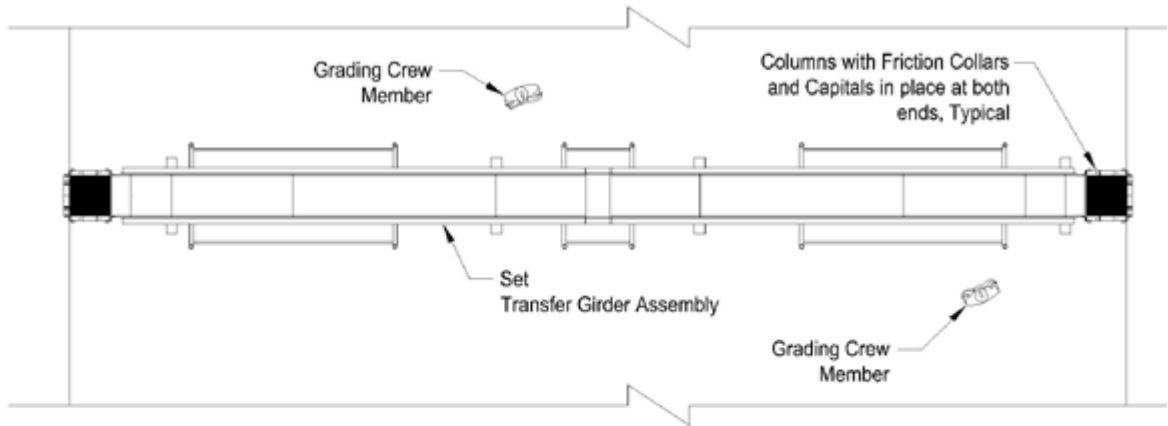

(T) The Grading Crew then make all final adjustment to the Transfer Girder.

1. The middle Frames can remain up in the Frame Hooks to create a larger pathway at the center of the Transfer Girder, as they are usually at the end bays where the Beam Form turn-around is required, this is also the reason for having no Column present in this position.

- When complete the standard Beam Forms may be set into the Entries of the Transfer
2. Girders.

## Transfer Girder Setting Procedures 2

## Beam Assembly Stripping Procedures

### A. The Day After the Pour

1. Remove all Capitals completely and relocate (See Page E-6).
2. Remove all of the Edge Decks and Bulk-Heads from the slab edges.
3. Ready the Beam for the P.T. Crew.
4. Note that having the pathway between the stripping area and the setting area clean and clear of all debris is essential to transporting the Beam Assemblies quickly and efficiently

### B. Stressing Day

- a. Place a single Post Shore at each end of the Beam Assembly, from the slab up to the Beam Soffit. This is just to assure that the Beam Assembly does break free of the concrete by its own weight.
- b. Remove all Cross Braces and place nearby.
- c. Remove 45 Degrees Push/Pull Braces (when present) and set nearby.

### C. Preparing the Beam Forms for Stripping

#### 1. Prep Crew (Top Jack System)

- a. Release the Top Jacks.
- b. Loosen the Steel Friction Clamps and the Steel Beam Clamps on the Top Jacks, but Do Not remove them.
- c. Release the Bottom Jacks.
- d. Lower the Top Jacks until the Stringers come to rest on the Stringer Support Arms and then slide the cantilevered Stringers back toward the center of the Beam Span until they are flush with the End Beams..
- e. Remove the Safety Fasteners on the Top Jacks, but keep nearby.
- f. Fold up all of the Frames (including the lowered Top Jacks) and collect them on the Frames Hooks that are hanging from the Soffit of the Beam Form.
- g. Go to next Beam Assembly and repeat this procedure.

#### 2. Prep Crew (Ledger System)

- a. Release the Bottom Jacks.
- b. Fold up all of the Frames and collect them on the Frames Hooks that are hanging from the Soffit of the Beam Form.
- c. Go to next Beam Assembly and repeat this procedure.

#### 3. Prep Crew (Header/Top Jack and 50 Kip Systems)

- a. Release the Bottom Jacks.
- b. Fold up all of the Frames and collect them on the Frames Hooks that are hanging from the Soffit of the Beam Form.
- d. Go to next Beam Assembly and repeat this procedure.

## Beam Assembly Stripping Procedures

### D. Stripping the Beam Forms

#### 1. Strip Crew (Top Jack System)

- a. Pick up the Beam Dollies with the Gas Forklifts and engage the Beam at the Soffit (make sure that the Beam Dolly's high side upright is facing toward the Forklift) and remove the Post Shores from the ends of the Beam Assembly.
- b. The Beam Dolly closest to the Stripping Saddle should then be lowered approximately 4" below the Beam Soffit and the Beam Dolly on the opposite end should be lowered approximately 2".
- c. Place Bottle Jacks onto the Stripping Saddles and start to jack the Beam Assembly down until it breaks free from the concrete.
- d. After the Beam breaks free, the Forklifts then may lower the Beam Assembly down to the slab. Turn the Beam Assembly approximately 30° to allow the Forklifts to move past the ends of the Beam.
- e. Place all of the Cross Braces and the Push/Pull Braces inside of the Beam and Transport the Assembly to the location of its next required use (See Page E-7).
- f. Repeat stripping procedure on the next beam Assembly in the Form-Set.

#### 2. Strip Crew (Ledger System)

- a. Pick up the Beam Dollies with the Gas Forklifts and engage the Beam at the Soffit (make sure that the Beam Dolly's high side upright is facing toward the Forklift) and remove the Post Shores from the ends of the Beam Assembly.
- b. The Beam Dolly closest to the jacking position should then be lowered approximately 4" below the Beam Soffit and the Beam Dolly on the opposite end should be lowered approximately 2".
- c. Place Bottle Jacks on top of the Stringer at the required jacking position and start to jack the Beam Assembly down until it break free from the concrete.
- d. After the Beam breaks free, the Forklifts then may lower the Beam Assembly down to the slab. Turn the Beam Assembly approximately 30° to allow the Forklifts to move past the ends of the Beam.
- e. Place all of the Cross Braces and the Push/Pull Braces inside of the Beam and Transport the Assembly to the location of its next required use (See Page E-7).
- f. Repeat stripping procedure on the next beam Assembly in the Form-Set.

#### 3. Strip Crew (Header/Top Jack and 50 Kip Systems)

- a. Pick up the Beam Dollies with the Gas Forklifts and engage the Beam at the Soffit (make sure that the Beam Dolly's high side upright is facing toward the Forklift) and remove the Post Shores from the ends of the Beam Assembly.
- b. The Beam Dolly closest to the Stripping Saddle should then be lowered approximately 4" below the Beam Soffit and the Beam Dolly on the opposite end should be lowered approximately 2".
- c. Place Bottle Jacks onto the Stripping Saddles and start to jack the Beam Assembly down until it break free from the concrete.
- d. After the Beam breaks free, the Forklifts then may lower the Beam Assembly down to the slab. Turn the Beam Assembly approximately 30° to allow the Forklifts to move past the ends of the Beam.
- e. Place all of the Cross Braces inside of the Beam and Transport the Assembly to the location of its next required use (See Page E-7).
- f. Repeat stripping procedure on the next beam Assembly in the Form-Set.

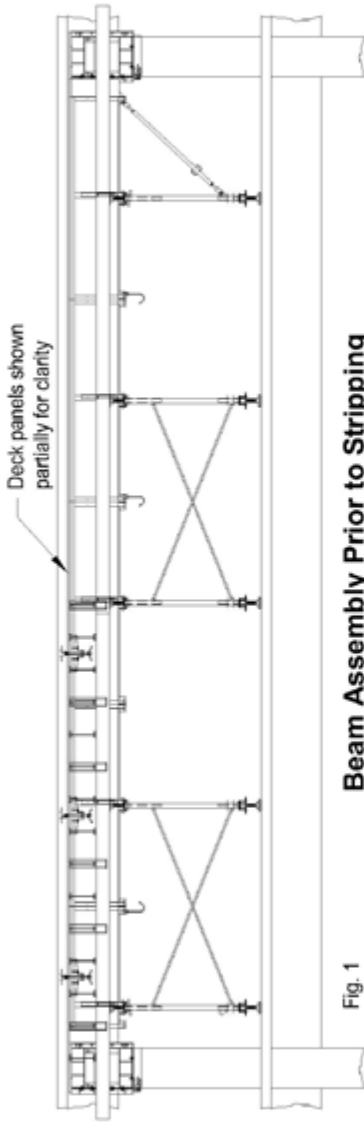

Fig. 1 **Beam Assembly Prior to Stripping**

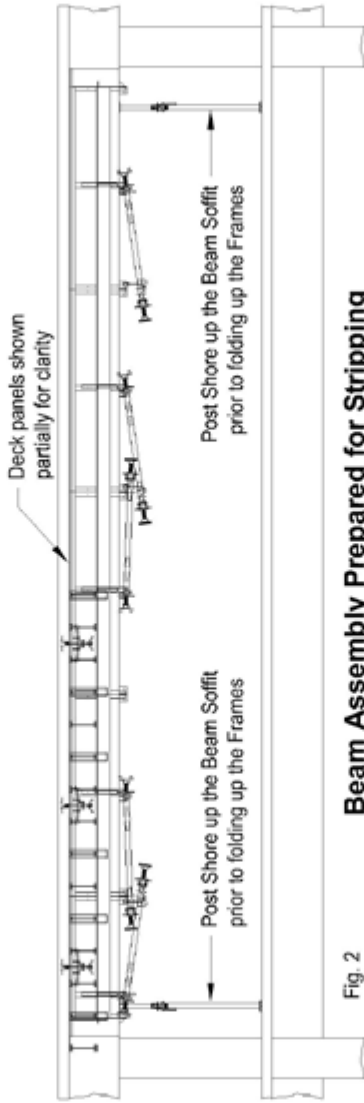

Fig. 2 **Beam Assembly Prepared for Stripping**

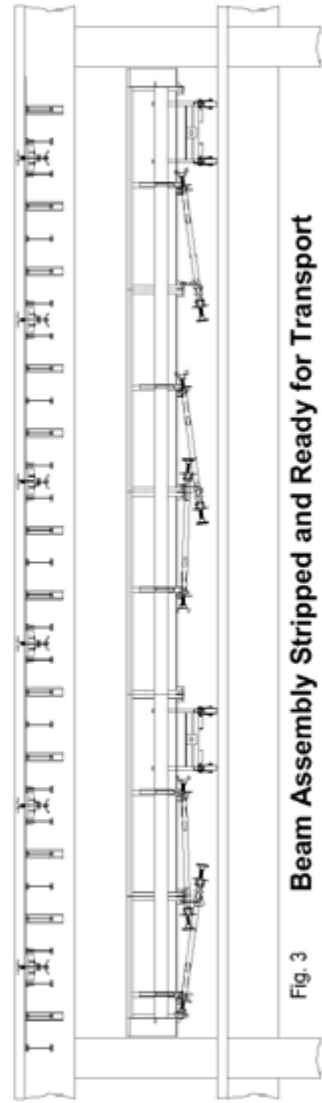

Fig. 3 **Beam Assembly Stripped and Ready for Transport**

## Beam Form Stripping Stages

SETTING AND  
STRIPPING  
PROCEDURES

When Parking Structures are designed, in most cases, the Bay Widths are somewhere between 18'-0" and 24'-0" and the Beam Spans are between 55'-0" and 63'-0". The length of the Deck Panels are therefore designed to fit the Bay Width. The length of the Deck Panels are therefore designed to fit the Bay Width this is achieved by taking the Bay Width, minus half of the Beam Width on each side, minus the Beam Draft on each side, and finally, minus an additional 1" gap on each side.

The width of the Deck Panels are typically based on 8'-0" for the Standard Deck Panels, the Exterior Deck Panels (which is usually notched to fit around the Exterior Columns and provides a minimum 30" exterior walkway), The Interior Ramp Separation Deck Panels (which may also have a smaller notch to fit around the Interior Columns and cut to match the Slab indentation into the side of the Column, plus another 3/4" for a Edge Deck). Smaller Filler Panels are also designed to fill the space between these panels until a Hand-Set gap is created. Hand-Set areas are typically one, two or three Joists wide, depending on the starting Beam Span. (See Page D-24 for additional Deck Panel references).

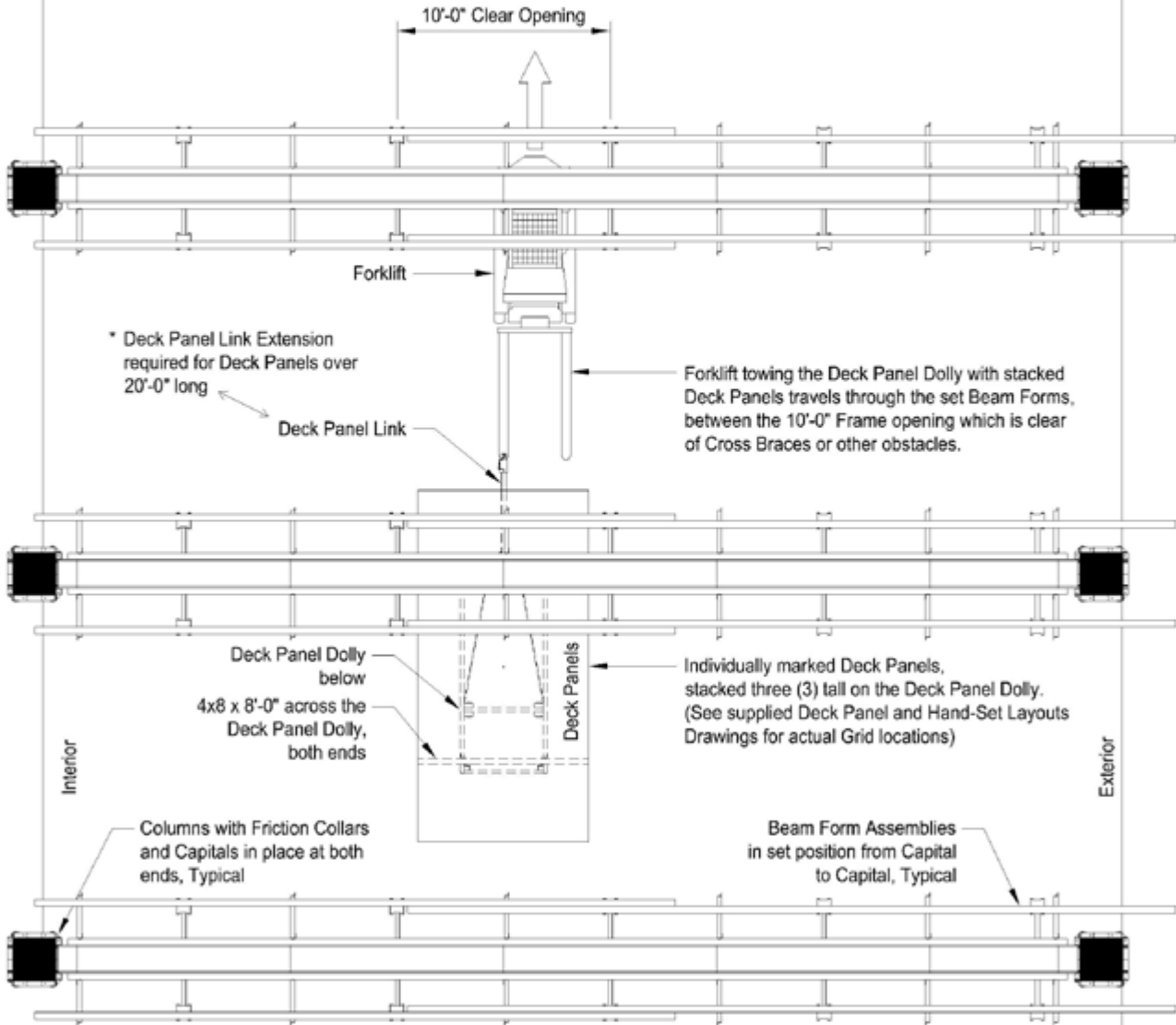

(A) Transport Crew transporting the Deck Panels from either the initial Build-Up Area or from the previous use Stripping Area. The individual Deck Panels are sitting on top of the Deck Panel Dolly and stacked three (3) tall. The first run, stack the Deck Panels, Exterior, Standard, Standard. The second run, stack the Deck Panels, Interior, Standard, Standard. The Third run is any additional Standard and Filler Panels.

## Transporting the Deck Panels

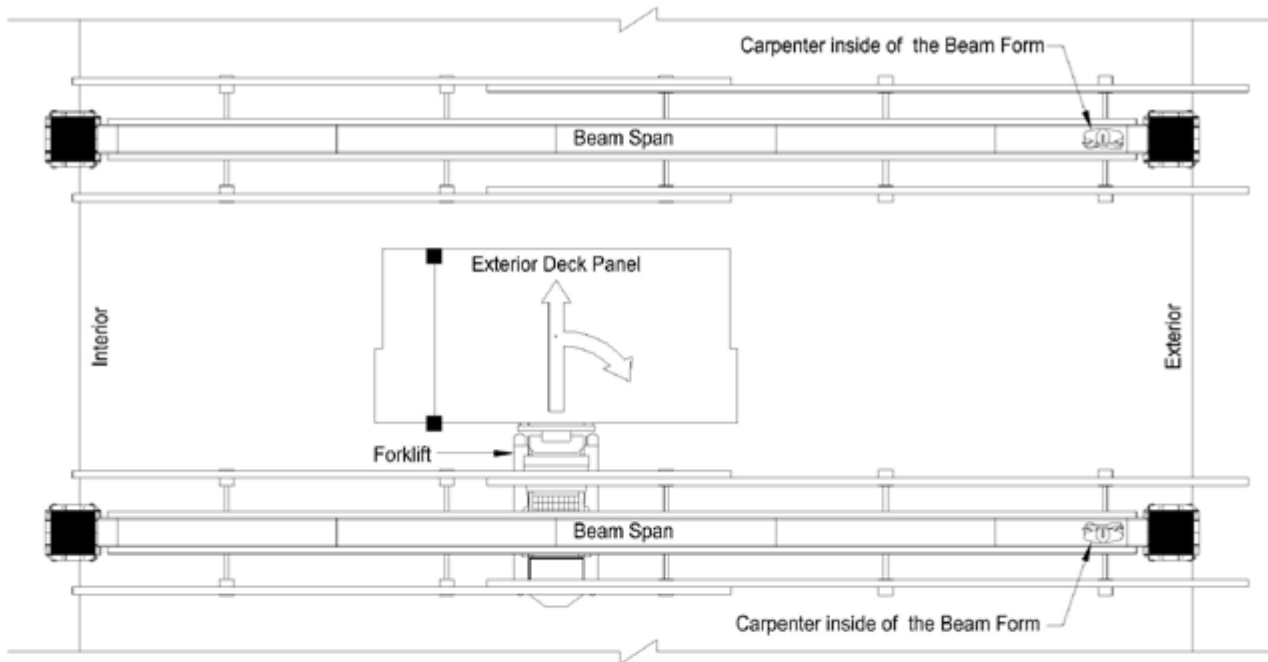

- (B) Using one (1) Forklift and two (2) Carpenters standing inside of two adjacent Beam Forms, the Forklift maneuvers the Exterior Deck Panel into the Bay that is currently being set (one of the Frames on the Beam Assemblies may need to be left in the up position to allow enough room for the Deck Panels to gain adequate access, the Frames can be lowered as soon as all Deck Panels are in place).
- (C) When the Deck Panel is within the Bay, the Forklift raises the Panel high enough to clear the top of the Beam Form and then rotates toward the Exterior side of the Bay.

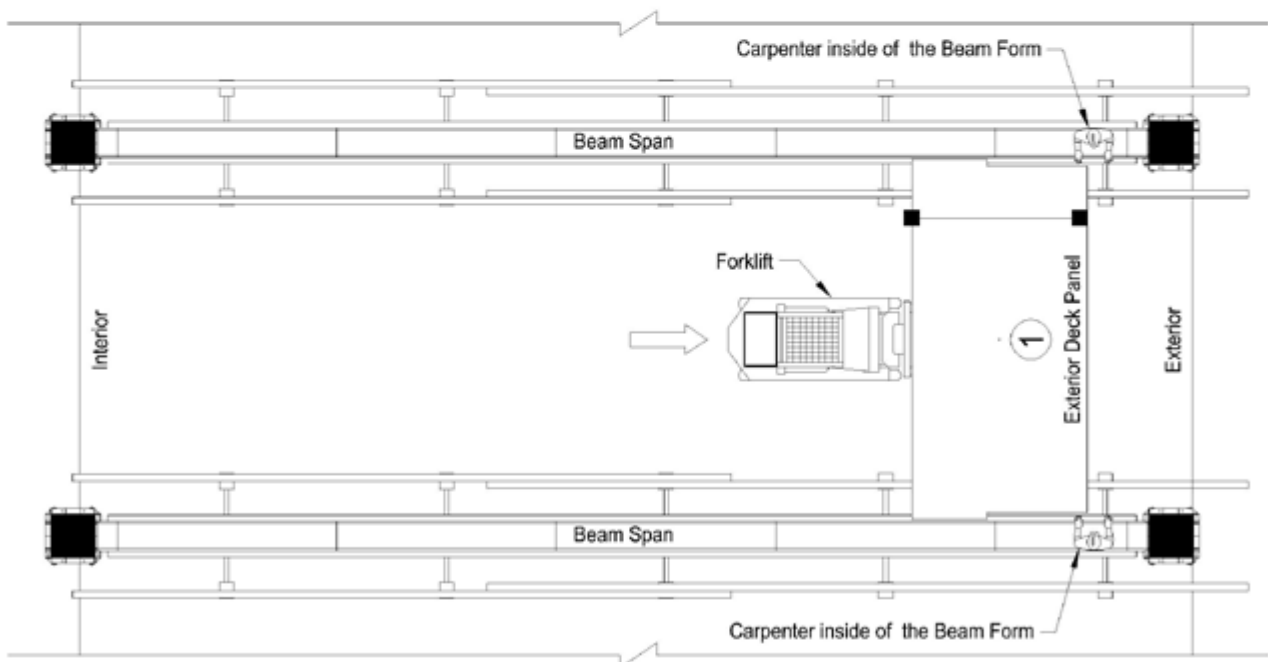

- (D) The Forklift then proceeds to move the Exterior Deck Panel toward the perimeter Capitals. The Carpenters, standing inside of Beam Forms, along with the Forklift operator, all communicate and work as a team to get the Exterior Deck Panel close to its required position.

## Deck Panel Setting Procedures 1

SETTING AND STRIPPING PROCEDURES



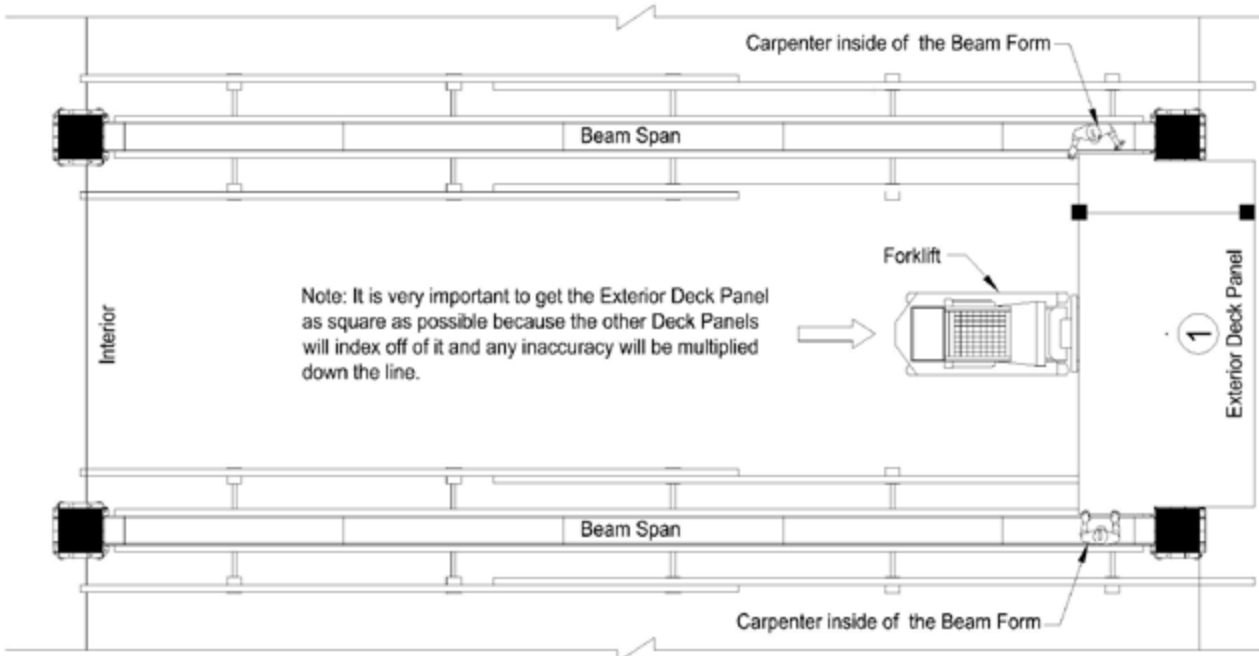

- (E) When the Exterior Deck Panel is in its required position, the Carpenters have the Forklift operator lower the Deck Panel until the Deck Joists come in contact with the Stringers and the Deck Ply comes in contact with the 2x4 Nails on the Beam Forms and the Capitals.
- (F) Using caution, the Carpenters use pry-bars and hammers to make final adjustments to square the Deck Panel up within the Bay. When placed, the Exterior Deck Panel may be nailed to the Beam Form Nailers using one (1) 6d nail in each corner of the Panel, four (4) nails are all that are required to secure the panel squarely.

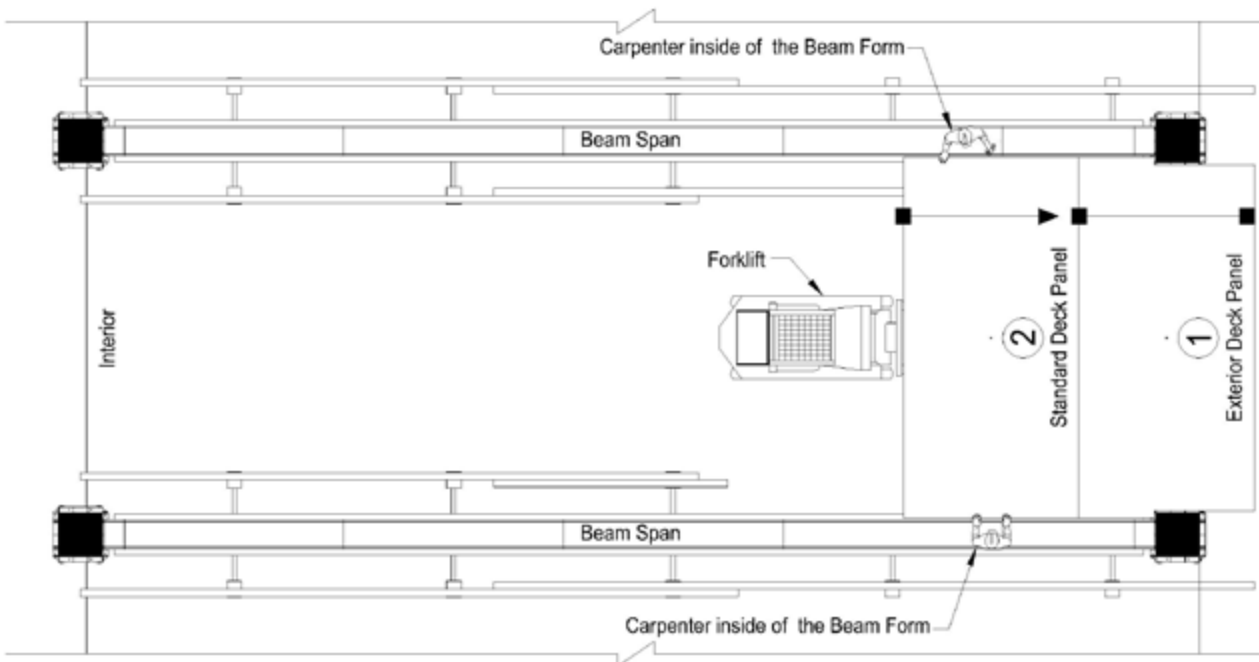

- (G) Following the same procedure, bring in the Second Deck Panel and maneuver it into position against the Exterior Deck Panel. Let the Leading Edge of the Second Deck Panel lap over the Exposed Joist of the Exterior Deck Panel. When in position, it can be nailed to the Beam Form Nailers using one (1) 6d nail in each corner of the Panel.

## Deck Panel Setting Procedures 2

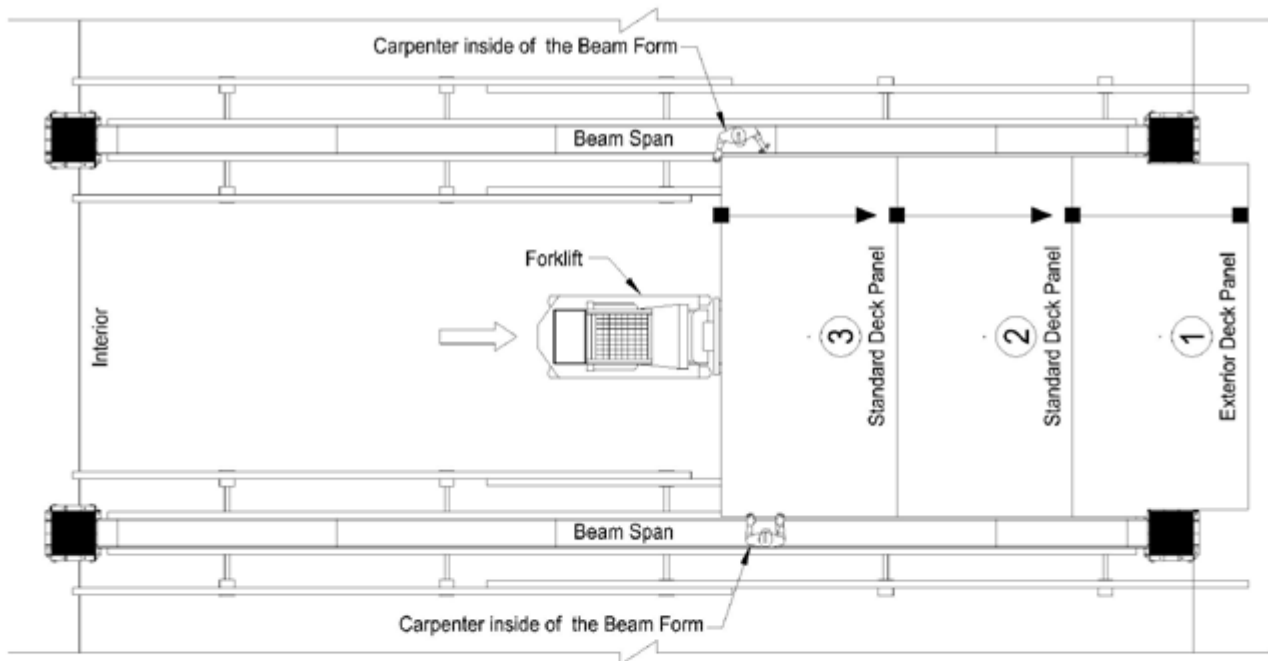

- (H) Following the same procedure, bring in the Third Deck Panel and maneuver it into position against the Second Deck Panel. Let the Leading Edge of the Third Deck Panel lap over the Exposed Joist of the Second Deck Panel. When in position, it can be nailed to the Beam Form Nailers using one (1) 6d nail in each corner of the Panel.

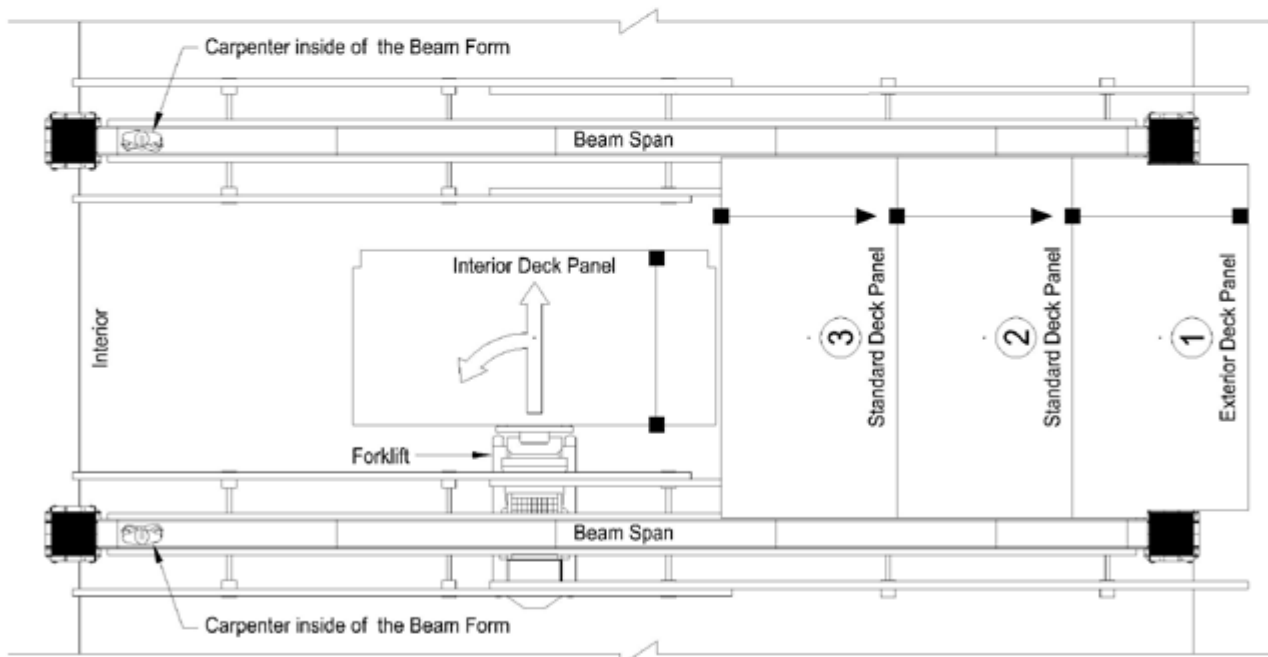

- (I) The two (2) Carpenters now move to the opposite end of the two adjacent Beam Forms, while the Forklift maneuvers the Interior Deck Panel into the current Bay.
- (J) When the Deck Panel is within the Bay, the Forklift raises the Panel high enough to clear the top of the Beam Form and then rotates toward the Interior side of the Bay.

### Deck Panel Setting Procedures 3

SETTING AND STRIPPING PROCEDURES

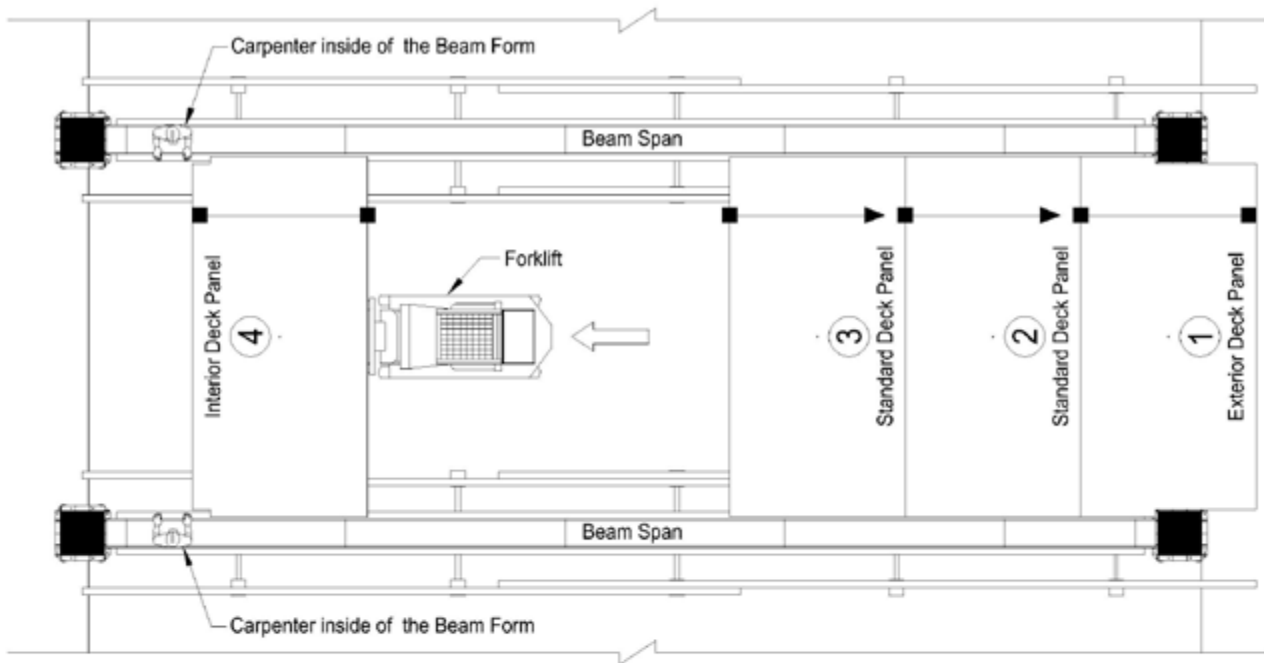

(K) The Forklift then proceeds to move the Interior Deck Panel toward the interior Capitals. The Carpenters, standing inside of Beam Forms, along with the Forklift operator, all communicate and work as a team to get the Interior Deck Panel close to its required position.

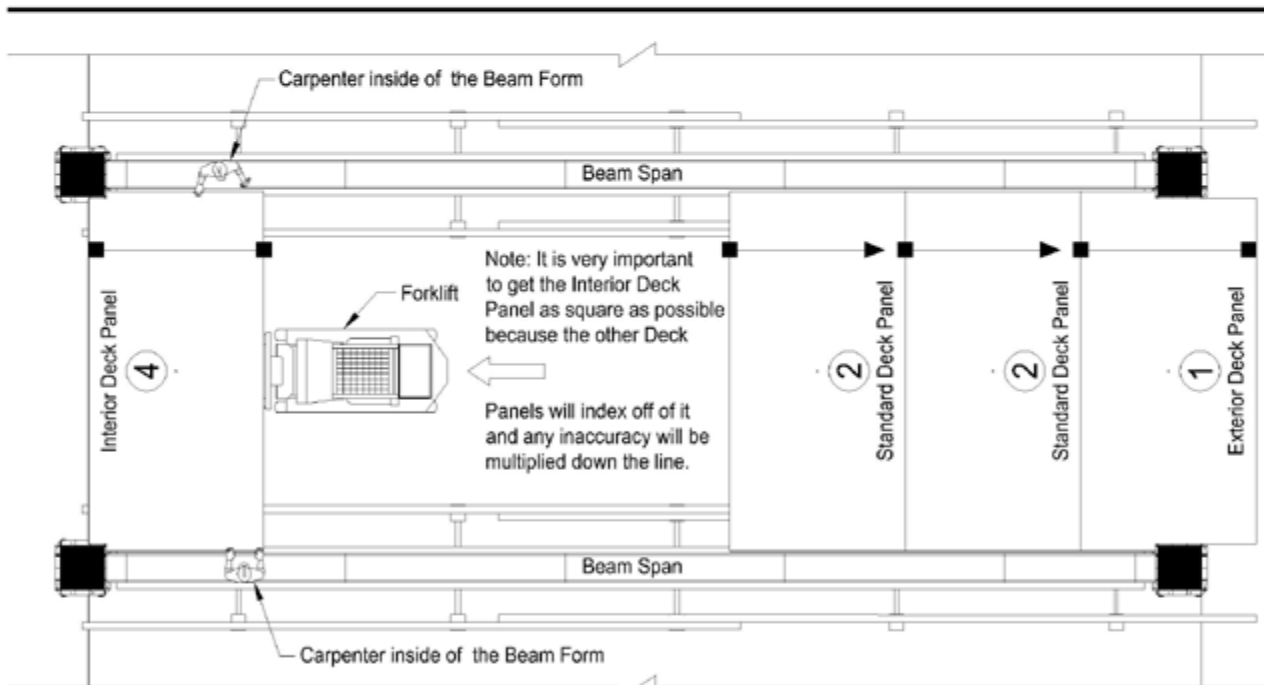

(L) When the Interior Deck Panel is in its required position, the Carpenters have the Forklift operator lower the Deck Panel until the Deck Joists come in contact with the Stringers and the Deck Ply comes in contact with the 2x4 Nails on the Beam Forms and the Capitals.

(M) Using caution, the Carpenters use pry-bars and hammers to make final adjustments to square the Deck Panel up within the Bay. When in place, the Interior Deck Panel may be nailed to the Beam Form Nailers using one (1) 6d nail in each corner of the Panel, four (4) nails are all that are required to secure the panel squarely.

## Deck Panel Setting Procedures 4

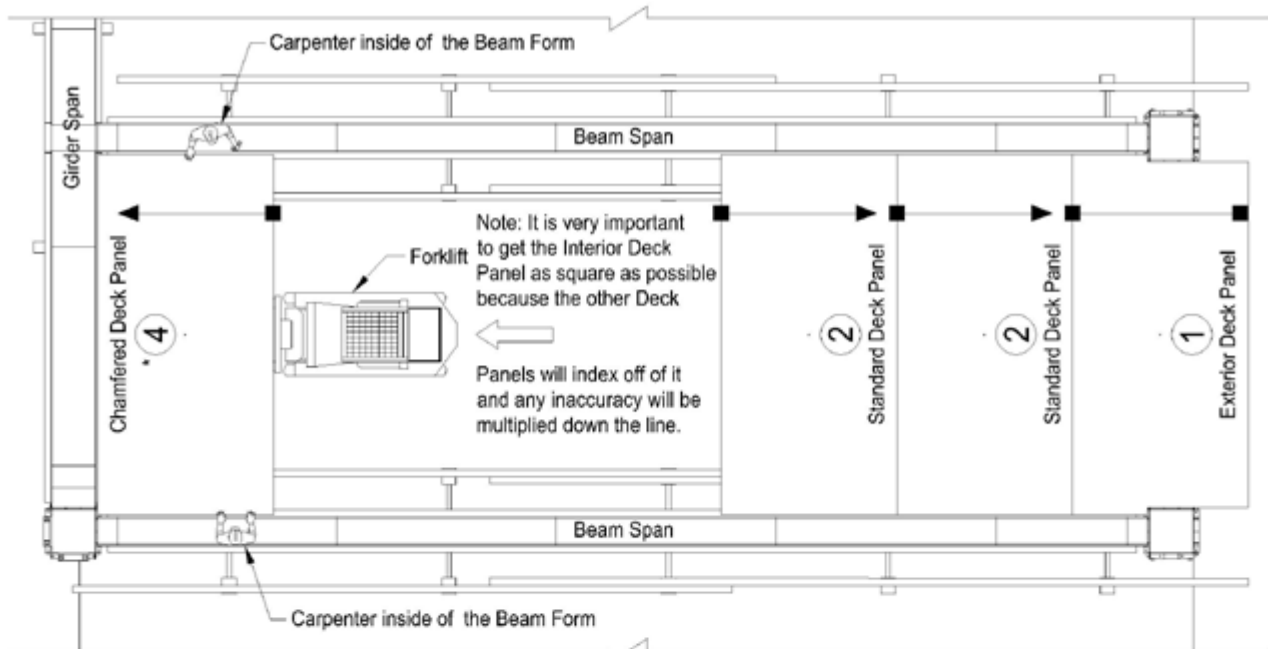

(N) When setting Deck Panels against an Interior Transfer Girder (similar to "K", "L" and "M" on Page E-20). Set the Chamfered Deck Panel (which is a Standard Deck Panel with a Chamfered Leading Edge). When the Chamfered Deck Panel is in its required position, the Carpenters have the Forklift operator lower the Deck Panel until the Deck Joists come in contact with the Stringers and the Deck Ply comes in contact with the 2x4 Nails on the Beam Forms, Transfer Girder and the Capitals.

(O) Using caution, the Carpenters use pry-bars and hammers to make final adjustments to square the Deck Panel up within the Bay. When placed, the Chamfered Deck Panel may be nailed to the Beam Form Nailers using one (1) 6d nail in each corner of the Panel, four (4) nails are all that are required to secure the panel squarely.

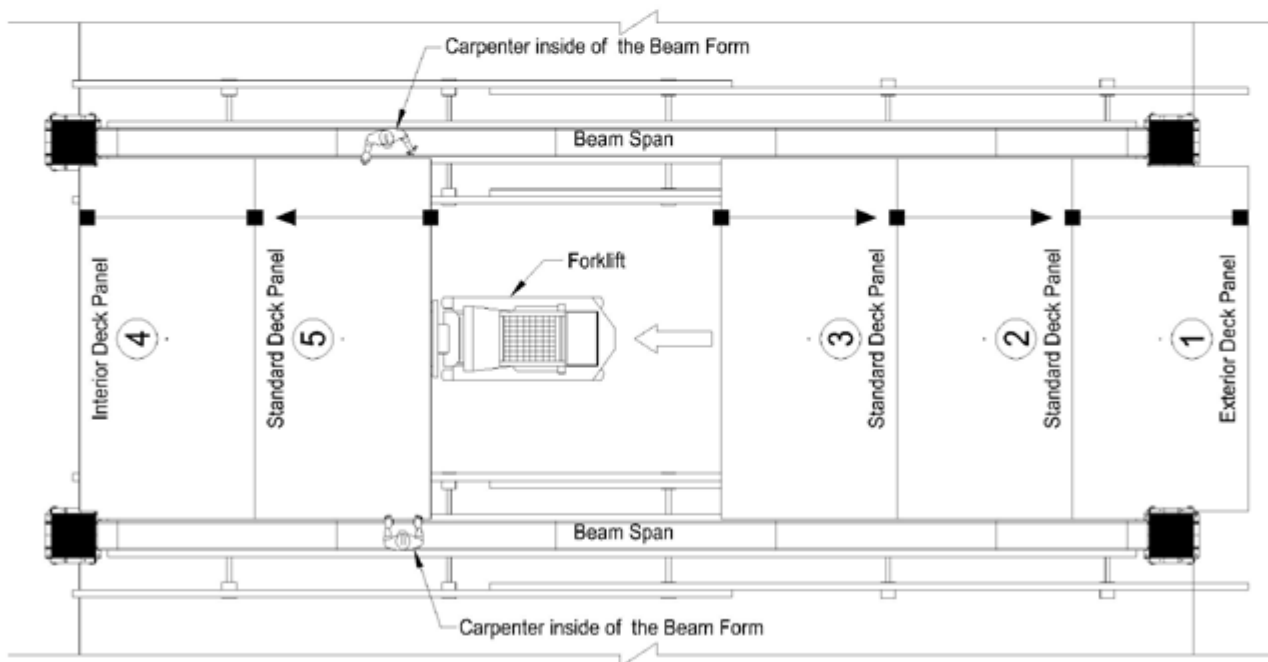

(P) Following the same procedure, bring in the Fifth Deck Panel and maneuver it into position against the Interior Deck Panel. Let the Leading Edge of the Fifth Deck Panel lap over the Exposed Joist of the Interior Deck Panel. When in position, it can be nailed to the Beam Form Nailers using one (1) 6d nail in each corner of the Panel.

## Deck Panel Setting Procedures 5

SETTING AND STRIPPING PROCEDURES

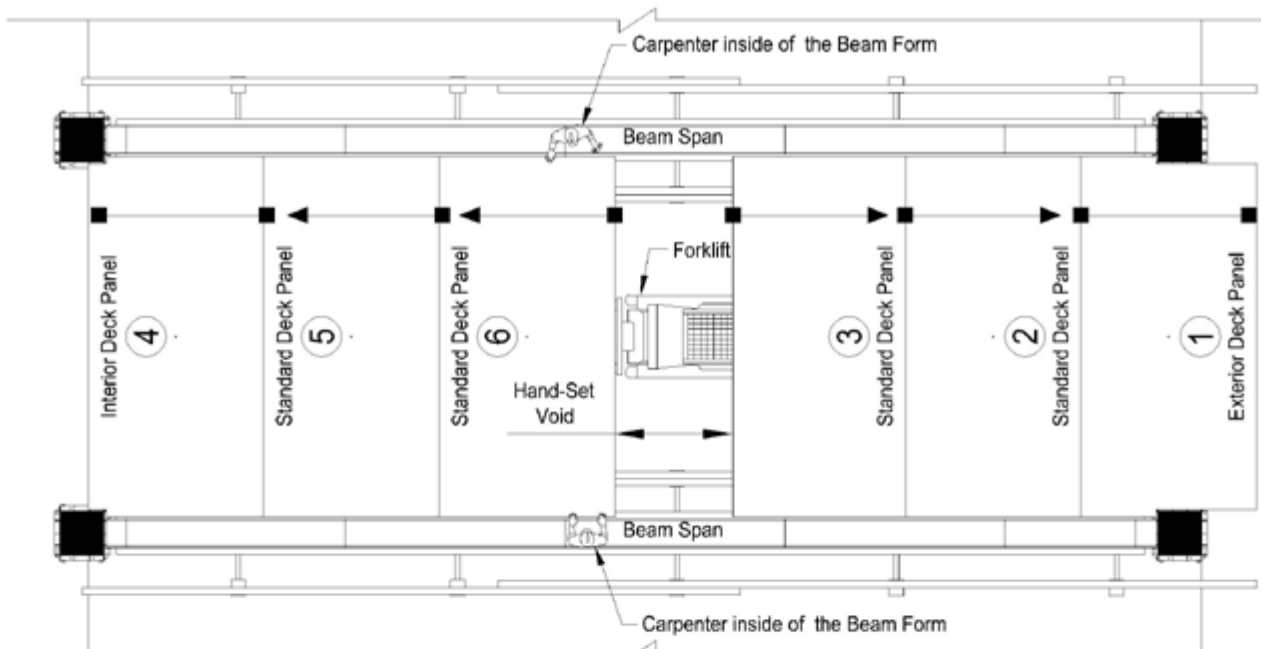

- (Q) Following the same procedure, bring in the Sixth Deck Panel and maneuver it into position against the Fifth Deck Panel. Let the Leading Edge of the Sixth Deck Panel lap over the Exposed Joist of the Fifth Deck Panel. When in position, it can be nailed to the Beam Form Nailers using one (1) 6d nail in each corner of the Panel.

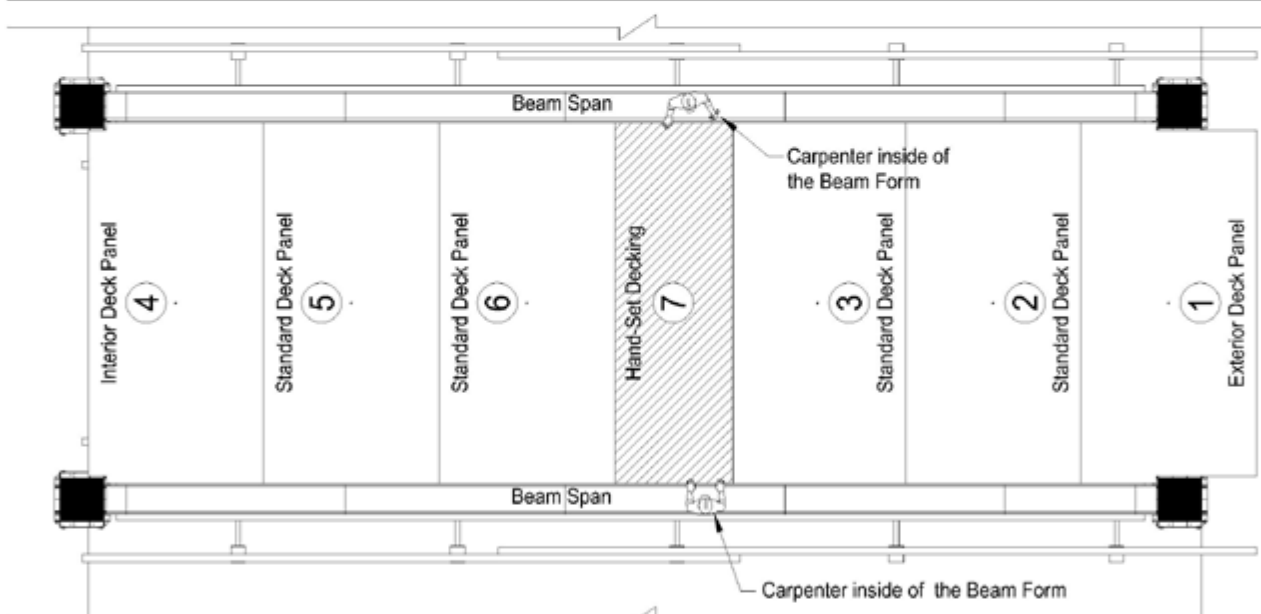

- (R) When all of the Deck Panels in the Span are in place, the size of the Hand-Set Void will be determined by the gap between Panel #3 and Panel #6, both of these Panels have been set so that each has an exposed Joist toward the Hand-Set. The Carpenters measure the width of the Void and cut a piece of 3/4" x 8'-0" wide Plywood to fit.
- (S) The Carpenters then drop loose Hand-Set Joists onto the Stringers, Do Not exceed the Joists Spacing of the Assembled Deck Panels. Hand-Sets are typically kept to One, Two or Three Joists wide (See Page D-27 for more information about Hand-Sets). When all of the Hand-Set Joists are in place, the Hand-Set Plywood Deck may be dropped into place over the Exposed Joists. When in position, it can be nailed to the Beam Form Nailers using one (1) 6d nail in each corner of the Plywood.

## Deck Panel Setting Procedures 6 Hand-Set Decking Setting Procedures 1

## Deck Panel Stripping Procedures

**A. After all of the Capital Assemblies and the Beam Assemblies within a Form-Set have been stripped, the Deck Panels are left behind, suspended from underside of the slab by the Deck Panel Bolts.**

**B. Strip the Deck Panels**

**1. Strip Crew (with Two (2) Electric Forklifts, Stripping Truss, and Stripping Wrench)**

- a. Engage the Stripping Truss with the cantilever side out from the Forklift.

Note 1: Do not disengage the Stripping Truss until all of the Deck Panels have been stripped in Form-Set.

Note 2: Due to the way that the Deck Panels are lapped over each other during the Setting Procedure (See Pages E-21 through E-26), the Deck Panels are stripped in the same sequence in which they were set, first up...first down.

- b. Position the Stripping Truss under the Exterior Deck Panel and lift it up just a bit to take the weight of the Deck Panel off of the Deck Bolt.
- c. With the Exterior Deck Panel supported by the Stripping Truss, the first man of the Stripping Crew releases the Deck Panel Bolt from the Deck Insert until it is completely unthreaded.
- d. The second man of the Stripping Crew operates an Electric Forklift to lift the loose Deck Panel off of the Stripping Truss. He then turns 90° and positions the Deck Panel on the Deck Panel Dolly. Note: Always pick panel off stripping truss from side opposite plywood overhang.
- e. Repeat this procedure for the first three Deck Panels, stacking one on top of the other (the Legs of the upper Panel rest on top of the Plywood of the Panel below, do not stack more than three high).
- f. See "Continued" procedures on Page E-28.

**2. Clean and Oil Crew**

- a. As the individual Deck Panels are stacked onto the Deck Panel Dolly, the Clean and Oil Crew preps the Panels for their next use.
- b. Clean, sweep, and oil the Deck Panels.
- c. Drive up and remove nails from Deck Panel corners.
- d. Replace any damaged Plywood.

## Deck Panel Stripping Procedures

### 3. Transport and Stock (with a Gas Forklift and a Deck Panel Dolly)

- a. After the Deck Panels are stacked on the Deck Panel Dolly and are ready for Transporting (See Page E-20 for transporting the Deck Panels procedures).
- b. Tow the Deck Panels with the Gas Forklift to their next pour location.
- c. When the transported Deck Panels arrive in the next pour location, lift the Deck Panels off of the Deck Panel Dolly and stock them neatly within the Bay in these stacks of three.
- d. Return the Gas Forklift and Deck Panel Dolly back to the area that is being stripped and continue to “transport and stock” using two crews until half of the Form-Set Deck Panels have been relocated.
- e. With half of the Deck Panels moved, one crew continues to make these transport runs while the second crew breaks off and starts to set the Deck Panels that are already waiting to be set (See Pages E-21 through E-26 for Setting Procedures).

### C. Strip the Deck Panels (Continued from “f” on Page E-27)

- g. After the first Deck Panels are on their way to the next pour location, a second Deck Panel Dolly is brought into position for the Strip Crew.
- h. Position the Stripping Truss under the Interior Deck Panel and proceed to strip the Panel down in the same manner, by lifting it slightly to take the weight of the Deck Panel off of the Deck Bolt.
- i. With the Interior Deck Panel supported by the Stripping Truss, the first man of the Stripping Crew releases the Deck Panel Bolt from the Deck Insert until it is completely unthreaded.
- k. The second man of the Stripping Crew operates an Electric Forklift to lift the loose Deck Panel off of the Stripping Truss. He then turns 90° and positions the Deck Panel on the Deck Panel Dolly.
- l. Repeat this procedure for the next three Deck Panels, stacking one on top of the other (the Legs of the upper Panel rest on top of the Plywood of the Panel below, do not stack more than three high).
- m. Keep stripping the Bays in this manner, working with the Clean and Oil Crew and keeping in time with the Transport Crew so that there is always a Deck Panel Dolly full of stripped and cleaned Deck panels ready to go as soon as the second Deck Panel Dolly is returned.
- n. Note that having the pathway between the stripping area and the setting area clean and clear of debris is essential to transporting the Deck Panels quickly and efficiently.

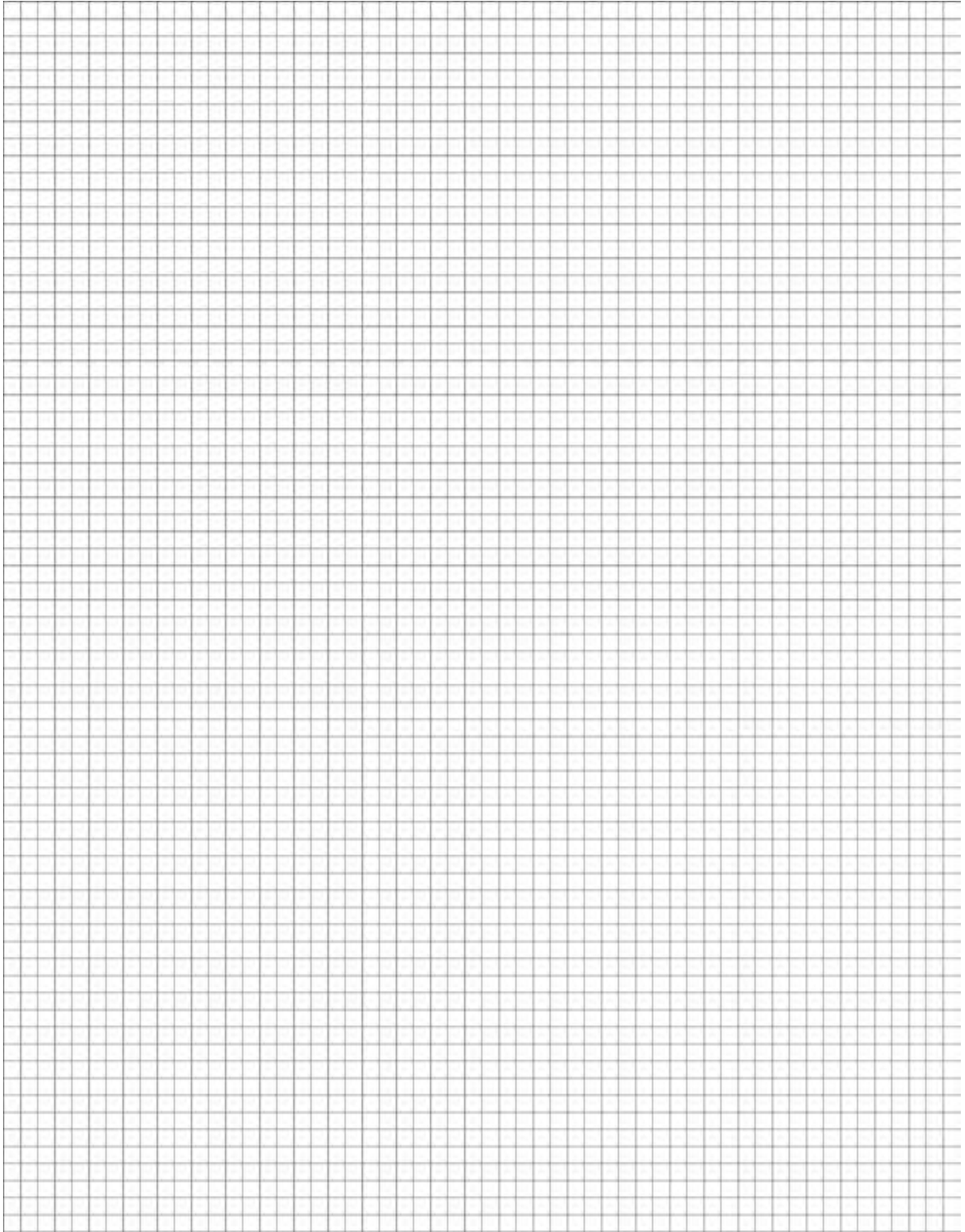



## Labor Management

The intent of this section is to make the Formwork System generate consistent profitability while producing a quality product through good Labor Management.

Whoever said “A tool is only as good as the hands that it is in” understood what we are trying to accomplish in the section.

Before writing this section, we took a look in Webster’s dictionary for the definition of the words we would use the most and found the following:

**System** - To bring together diverse parts subject to a common plan serving a common purpose. (We, in this section, would like to think of the system as the tool).

**Management** - The skilled handling of something (like a tool, a machine, or a system). The conducting or supervision of something. The supervising of an activator with responsibility for results. (In this section, we would like to think of the Labor Manager as the Foreman.)

**Foreman** - A specially trained workman who works with and commonly leads a gang or crew. (Our intent in this section is to identify the role of a Foreman.)

As part of our system’s package, Symons By Dayton Superior offers, on a no charge basis, five days of field time to orient our system to the customer. These five days are normally scheduled in two trips. The first is for systems build-up; the second is for production.

## Labor Management

### SYSTEMS BUILD-UP

The systems' build-up is started when there is slab-on-grade. The systems' build-up should be done on that portion of the job site so as not to affect setting up the first production pour.

Systems build-up entails four components and two crews. Seven men for the Beam Form Assemblies build-up and six men for the Deck Panel Assemblies build-up. If a total crew is not available when a Symons representative is on site, assign four of your best men and let them learn by doing on all four components in the three days our representative is there. Too often, the men our representative trains are reassigned to other work and the new men assigned put it together with no instructions—a costly decision. The Deck Panel crew will also build the ramp capitals. The Beam Form crew will also assemble the standard capitals.

### PRODUCTION

The production section should be read periodically to make sure the system is being handled effectively and the schedule is being met.

### SMALL IS PRODUCTIVE

We believe that two-man teams set the pace on a job site. A crew made up of four, two-man teams will pace each other and more quality production is achieved.

### THE PLAN

If you do not have a plan, everybody looks busy yet production drops.

For lack of a plan, everything on the job site gets moved two or three times. It is more cost effective when the job is done once.

With a plan, people know what they are expected to accomplish and production becomes a reality.

A plan is a measure (e.g. We are going to move sixteen Beams today). What gets measured gets done.

**MATERIAL LOGISTICS** - Plan for each pour. Example: Where do the column forms, wall form up-turns, and form aligner braces go so as not to stop production?

## Labor Management

### GOLDEN RULES:

For columns and capitals, when you strip a Column move it to a staging area. When you strip a Capital transport it and put it back up.

For Beam Forms and Deck Panels, do not take it down until you can put it back up. If the plan or sequence is wrong, change it.

Do not move out of a Pour Area until first, the Area has been swept out, and second, all materials that do not belong there have been moved out.

Do not move into of a Pour Area until first, the area has been swept out, and second, all materials that do not belong there have been moved out.

To master productivity on the Job Site, there is only one rule. You just keep pushing the job plan for that day.

If the whole crew is not available, replace missing people as soon as possible. When you compromise the system or the work, the whole plan gets compromised.

### CAUSE AND EFFECT

The cause is housekeeping. The effect is twofold: First, the production is stopped and started while the crew moves material that should not have been there in the first place. Second, the crew production momentum is lost and this is difficult to regain.

### PEOPLE

People have to believe it can be done; therefore, show them that it can be done.

You cannot build a work environment and motivate men if you have poor housekeeping.

Getting the best from each man is the key to the success of the job.

To work toward achievable objectives, you must have the right attitude and a positive commitment from each man on the job. A negative attitude and complaining cannot be tolerated.

## Labor Management

### PALLETS AND RACKS OR DOLLIES

Everything on the job site should be moved on a Pallet (e.g. Capital Assemblies), Racks (e.g. Post Shores), or Dollies (e.g. Beam Form Assemblies, Transfer Girder Assemblies and Deck Panels).

### GANG BOX

Each morning the Foreman meets his crew at the gang box for the following:

- Outline the work plan and the objectives for the day.
- Assign the two-man teams within the crew.
- Check to see if the right tools are available.
- Make sure all the moving equipment is available and in good condition.

### THE FOREMAN

The Foreman is a Labor Manager, Systems Instructor, and he is key to quality control.

The Foreman should manage by being visible to the crew. Being on the work deck and envisioning the problem before the problem is a problem (e.g. Top and Bottom Jacks need oil, men do not have the right tools for the job assignment, the men do not know the procedure and need training, etc.).

If the Foreman is not present during work, the workers will not believe he is serious about the production plan in the first place.

By making his presence known, the Foreman can assure himself the men are at the right speed and heading in the right direction to accomplish the plan.

### SYMONS BY DAYTON SUPERIOR – GOAL

Our goal is to give the best company service in the Forming industry.

The Symons GBS System is a quality product designed to produce a superior product when disciplined and instructed labor wants to produce such a product.

## Labor Management

### **STUDY AND KNOW THE ARCHITECTURAL AND STRUCTURAL DRAWINGS:**

It is crucial that the Superintendent, the Project Manager and the Foreman have all studied the Architectural and Structural drawings for the job prior to the job start up.

Each should review the drawings and have a clear understanding and vision of the Structure. Potential trouble areas should be noted and addressed very early on. Write RFI's to the Architect or the Structural Engineer and get any mistakes or incomplete drawings corrected before they escalate into a "Field Problem" and slow down the schedule.

The GBS team will be working off of these same drawings and it is highly important that we have the most up-to-date set of Architectural and Structural drawings on hand and that any updates, revisions or answered RFI's are forwarded to us, keep us in the loop, make us part of your team.

### **STUDY AND KNOW THE GBS DRAWINGS:**

The GBS drawings will be supplied to the Contractor in sections that make up a full set of drawings.

1. Cover Sheet, Safety Sheet, Information and Reference Sheet.
2. Plan Views for each level, including: Beam Form and Falsework Layouts, Capital and Ramp Capital Placement Layouts and Deck Panel Layouts.
3. Beam Elevations, including: Beams, Transfer Girders and Falsework. Beam and Deck Sections, as required. Beam and Component Bolt-Up Procedures, Post Shore Usage Standards. High-Bay Assemblies, as required.
4. Capital Assemblies for all included Capitals. Ramp Capital Standards and Ramp Capital Assemblies, as required.
5. Deck Panel Standards and Deck Panel Assemblies for all included Deck Panels.
6. Load-Out Standards.

### **STUDY AND KNOW THE GBS MANUALS:**

The GBS manuals will be supplied to the Contractor ahead of the equipment.

1. The GBS Field Manual: Completely study the Field Manual for a good overview of the benefits of choosing the GBS system.
2. The GBS Equipment Book: Review the Equipment Book and get to know the individual parts by name; this is essential to proper communication.

### **REVIEW THE GBS JOB INFORMATION CONTROL REPORT (JICR):**

The JICR is just another name for Bill of Materials (BOM), all of the supplied equipment is accounted for on the JICR. Revisions are made to adjust for any supply or additional request changes that are made prior to of during the job..



**Forklift Requirements**  
 2 Gas Forklifts  
 2 Electric Forklifts

## TWO FORM-SET PRODUCTION SCHEDULE

### Standard Pour Schedule

**NOTES:**

1. This schedule assumes the concrete can be stressed two days after placement.
2. This schedule is for 24 weeks. Adjust the length to the number of weeks required complete your job.

**Crew Size**  
 1 Foreman  
 8 Carpenters  
 4 Laborers  
 13 Total

EXAMPLE OF LABOR MANAGEMENT



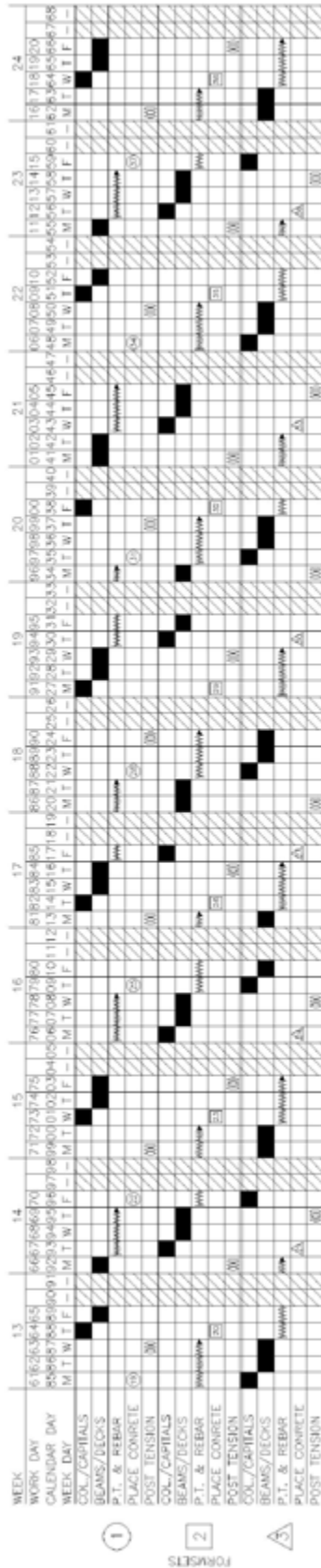
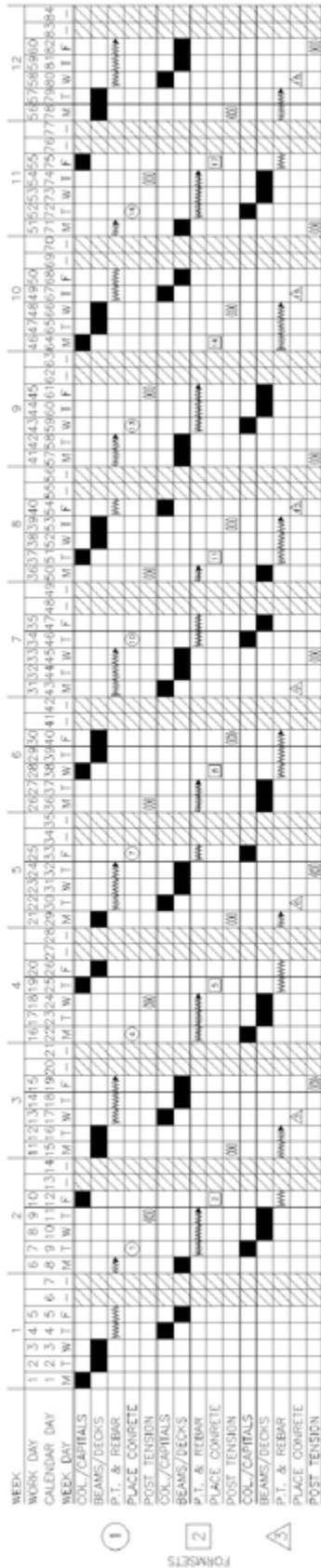

**Forklift Requirements**  
 3 Gas Forklifts  
 2 Electric Forklifts

### THREE FORM-SET PRODUCTION SCHEDULE Accelerated Pour Schedule

**Crew Size**  
 1 Foreman  
 10 Carpenters  
 4 Laborers  
 15 Total

- NOTES:**
1. This schedule assumes the concrete can be stressed two days after placement.
  2. This schedule is for 24 weeks. Adjust the length to the number of weeks required complete your job.

EXAMPLE OF LABOR MANAGEMENT



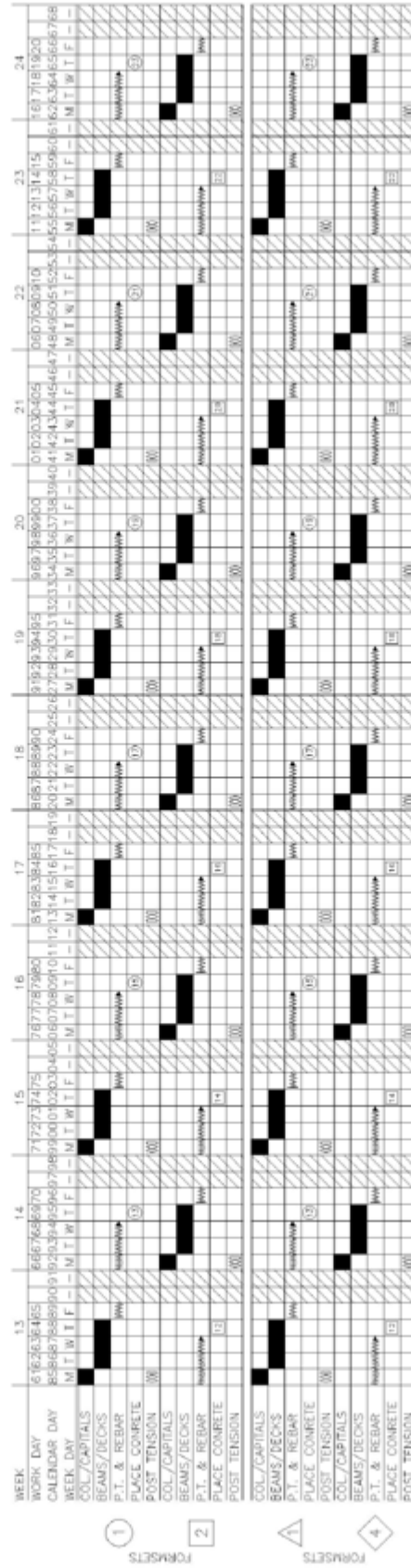
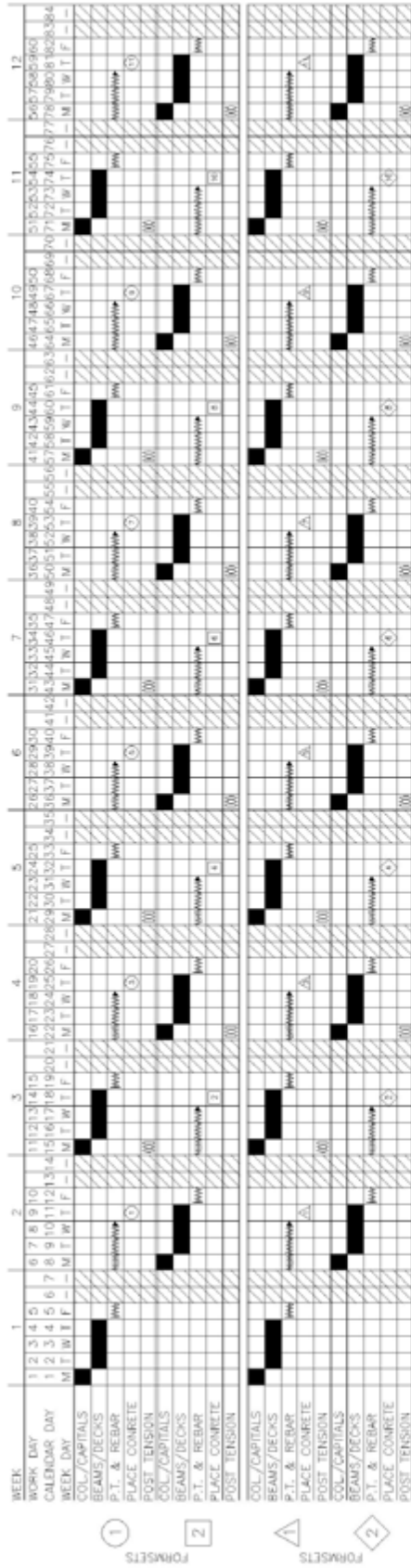

**FOUR FORM-SET PRODUCTION SCHEDULE**  
**Accelerated Pour Schedule**

**NOTES:**

- This schedule assumes the concrete can be stressed two days after placement.
- This schedule is for 24 weeks. Adjust the length to the number of weeks required complete your job.

<b>Crew "A"</b>	<b>Crew "B"</b>	<b>Crew "A"</b>	<b>Crew "A"</b>
<b>Crew Size</b>	<b>Crew Size</b>	<b>Formlift Requirements</b>	<b>Formlift Requirements</b>
1 Foreman	1 Foreman	2 Gas Forklifts	2 Gas Forklifts
8 Carpenters	8 Carpenters	2 Electric Forklifts	2 Electric Forklifts
4 Laborers	4 Laborers		
<b>13 Total</b>	<b>13 Total</b>		
<b>Total Crew Size</b>		<b>Total Forklift Requirements</b>	
2 Foreman	2 Foreman	4 Gas Forklifts	4 Gas Forklifts
16 Carpenters	16 Carpenters	4 Electric Forklifts	4 Electric Forklifts
8 Laborers	8 Laborers		
<b>26 Total</b>	<b>26 Total</b>		

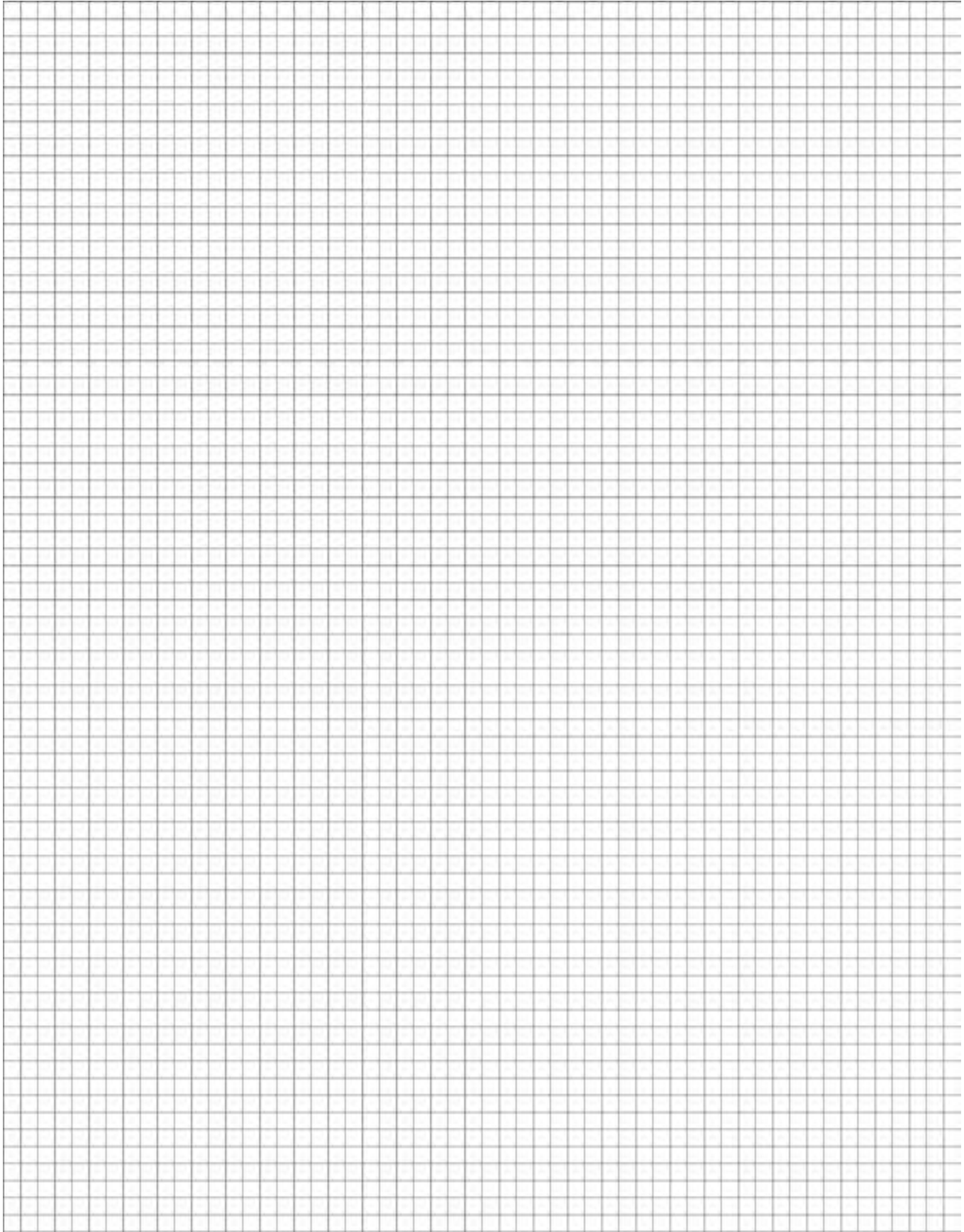



**Cross Braces**

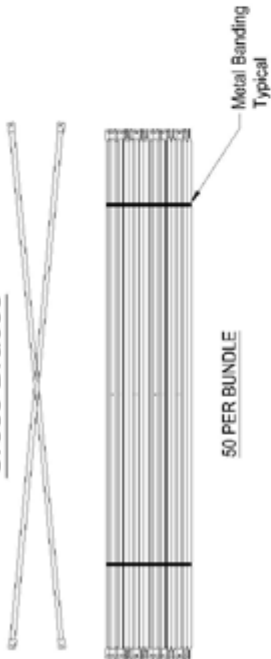

**45° Push/Pull Braces**

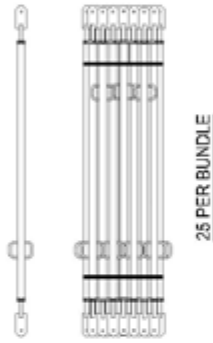

**Leg Extensions**



**Cantilever Frame Base**

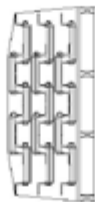

**NOTES:**

1. STACK ALL CANTILEVER FRAME BASES INTERLOCKING ON PALLET(S) AND BAND TOGETHER.
2. PACK ADJUSTABLE LEG SLIDERS AND C-PINS TOGETHER AS SHOWN. (100 PER BOX)
3. PACK FRAME TIE BACK TABS AND SLAB TIE BACK TABS TOGETHER AS SHOWN. (ALL REQUIRED FOR JOB)

**Cantilever Push/Pull Tie-Back Brace**

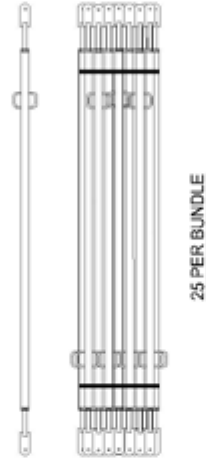

**Adjustable Leg Sliders with "C" Pins**

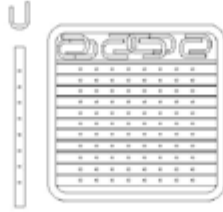

SEE NOTE "2"

**Top Jacks**

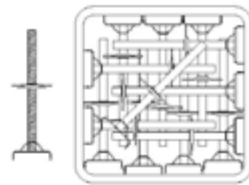

**Bottom Jacks**

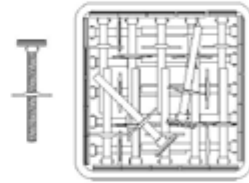

**Jack Retainers and Collars**

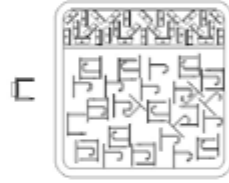

**Frame and Slab Tie-Back Tabs**

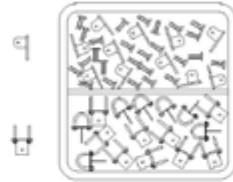

SEE NOTE "3"

**Frame Coupling Pins**



**Packing and Shipping Procedure for Frame Equipment and Jack Equipment**

PACKING AND SHIPPING DETAILS

Post Shores

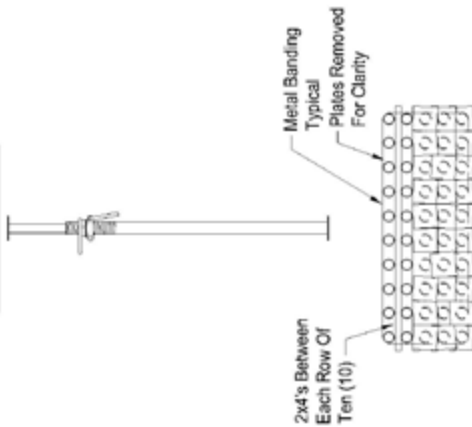

SEE NOTE "1"

Plates Removed For Clarity

Reshore Jacks

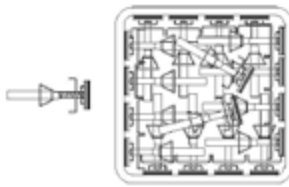

40 PER BOX

Hinged Scaffold Brackets

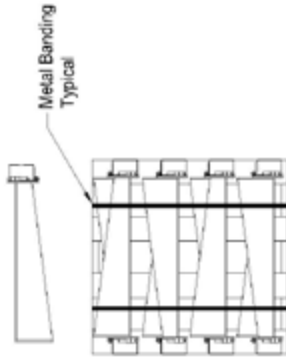

SEE NOTE "2"

Edge Deck Scaffold Brackets

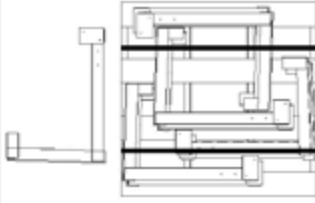

SEE NOTE "3"

Stringer Support Arms

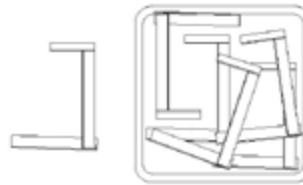

28 PER BOX

Ledger Brackets (Up, Down and Level)

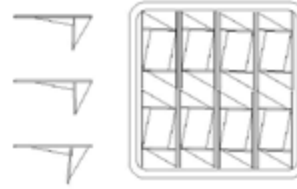

SEE NOTE "4"

Stripping Saddles and Frame Hooks





SEE NOTE "5"

**NOTES:**

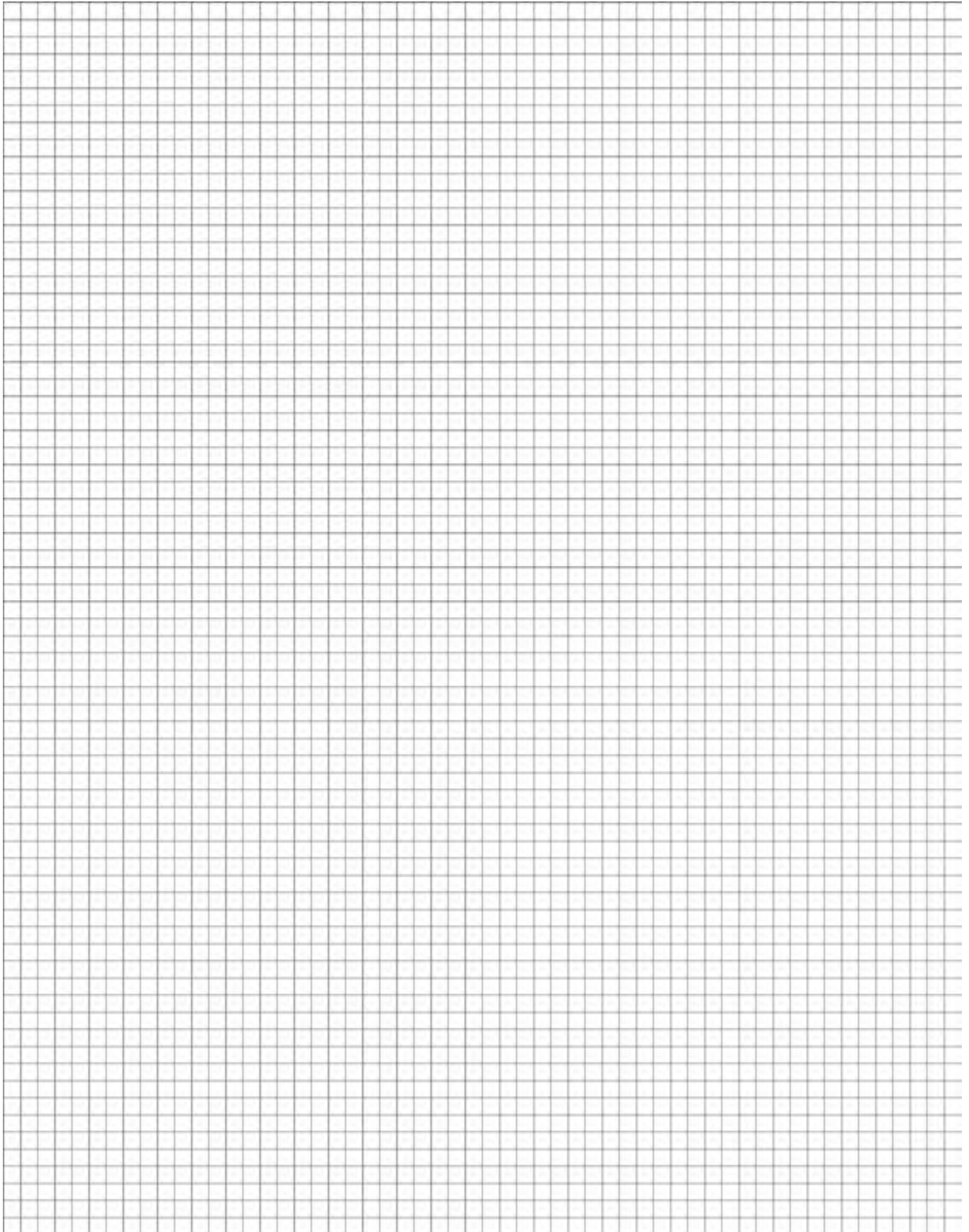
1. STACK POST SHORES TEN (10) WIDE x FIVE (5) HIGH, WITH 2x4's BETWEEN EACH ROW OF TEN (10) & BAND TOGETHER. (50 PER BUNDLE)
2. ALTERNATE HINGE SCAFFOLD BRACKETS END TO END ON PALLET AS SHOWN. (20 PER PALLET)
3. STACK EDGE DECK SCAFFOLD BRACKETS ON PALLET AS SHOWN. USE EXTRA AVAILABLE SPACE FOR MISCELLANEOUS SUPPLIES, NUTS, BOLTS, ETC. BAND WITH METAL BANDING. (20 PER PALLET)
4. PACK LEDGER BRACKETS (UP, DOWN AND/OR LEVEL) INTERLOCKING AS SHOWN. BAND WITH METAL BANDING. (120 SINGLE OR 60 DOUBLE PER BOX)
5. PACK STRIPPING SADDLES & FRAME HOOKS TOGETHER AS SHOWN. (ALL REQUIRED FOR JOB)



	<h2> <b>WARNING</b></h2> <h3>Improper Use of Concrete Forms and Shores Can Cause Severe Injury or Death</h3> <p>Read, understand and follow the information and instructions in this publication before using any of the concrete construction products displayed herein. When in doubt about the proper use or installation of any Dayton Superior concrete accessory, immediately contact the nearest Dayton Superior Service Center or Technical Service Department for clarification. See back cover for your nearest location.</p>
---	--

Dayton Superior products are intended for use by trained, qualified and experienced workmen only. Misuse or lack of supervision and/or inspection can contribute to serious accidents or deaths. Any application other than those shown in this publication should be carefully tested before use.

The user of Dayton Superior products must evaluate the product application, determine the safe working load and control all field conditions to prevent applications of loads in excess of a product's safe working load. Safety factors shown in this publication are approximate minimum values. The data used to develop safe working loads for products displayed in this publication are a combination of actual testing and/or other industry sources. Recommended safe working loads given for the products in this publication must never be exceeded.

---

## Worn Working Parts

For safety, concrete forms must be properly used and maintained. Concrete products shown in this publication may be subject to wear, overloading, corrosion, deformation, intentional alteration and other factors that may affect the device's performance. All reusable products must be inspected regularly by the user to determine if they may be used at the rated safe working load or should be removed from service. The frequency of inspections depends upon factors such as (but not limited to) the amount of use, period of service and environment. It is the responsibility of the user to schedule inspections for wear and remove the hardware from service when wear is noted.

---

## Shop or Field Modification

Welding can compromise a product's safe working load value and cause hazardous situations. Knowledge of materials, heat treating and welding procedures is necessary for proper welding. Consult a local welding supply dealer for assistance in determining required welding procedures.

Since Dayton Superior cannot control workmanship or conditions in which modifications are done, Dayton Superior cannot be responsible for any product altered in the field.

---

## Interchangeability

Many concrete products that Dayton Superior manufactures are designed as part of a system. Dayton Superior strongly discourages efforts to interchange products supplied by other manufacturers with components supplied by Dayton Superior. When used properly, and in accordance with published instructions, Dayton Superior products have proven to be among the best designed and safest in the industry. Used improperly or with incompatible components supplied by other manufacturers, Dayton Superior products or systems may be rendered unsafe.

---

## Installation

### WARNING

1. Dayton Superior Corporation products shall be installed and used only as indicated on the Dayton Superior Corporation installation guidelines and training materials.
2. Dayton Superior Corporation products must never be used for a purpose other than the purpose for which they were designed or in a manner that exceeds specific load ratings.
3. All instructions are to be completely followed to ensure proper and safe installation and performance
4. Any improper misuse, misapplication, installation, or other failure to follow Dayton Superior Corporation's instruction may cause product malfunction, property damage, serious bodily injury and death.

### THE CUSTOMER IS RESPONSIBLE FOR THE FOLLOWING:

1. Conformance to all governing codes
2. Use of appropriate industry standard hardware
3. The integrity of structures to which the products are attached, including their capability to safely accept the loads imposed, as evaluated by a qualified engineer.

### SAFETY INSTRUCTIONS:

All governing codes and regulations and those required by the job site must be observed. Always use appropriate safety equipment

---

## Design Changes

Dayton Superior reserves the right to change product designs, rated loads and product dimensions at any time without prior notice.

**Note: See Safety Notes and Safety Factor Information.**



**SYMONS**<sup>®</sup>  
BY DAYTON SUPERIOR

1125 Byers Road  
Miamisburg, OH 45342  
937-866-0711  
888-977-9600

**THE  
POWER  
OF RED**<sup>™</sup>



More Info