

General Information:

The Styrene and ABS formliners are an economical solution for providing architectural pattern reproductions. The Styrene plastic formliner is a perfect alternative for single use applications which costs less than other liners. The ABS plastic formliner exhibits good impact resistance and excellent overall performance. Its reuse factor is 10, subject to pattern configuration, proper handling and jobsite configurations.

Care and Handling:

To protect from thermal deformation, formliners should not be exposed to temperatures above 140°F (60°C). To avoid discoloration from sunlight exposure, formliners should be covered with a tarpaulin when not in use. This helps prolong the life of the material and keeps the material clean.

Form Liners are subject to thermal expansion and contraction +/- 1/8" @ 70°F. Keep away from steam, acids, and certain fuels.

Styrene	ABS
Product Code #	Product Code #
F70330	F70270
Uses	Uses
1	Up to 10
Material Thickness	Material Thickness
.090	.110
Standard Dimensions	Standard Dimensions
10' x 4'	10' x 4'
Color	Color
White	Gray



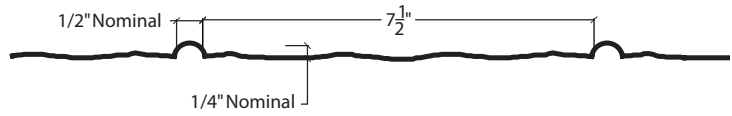
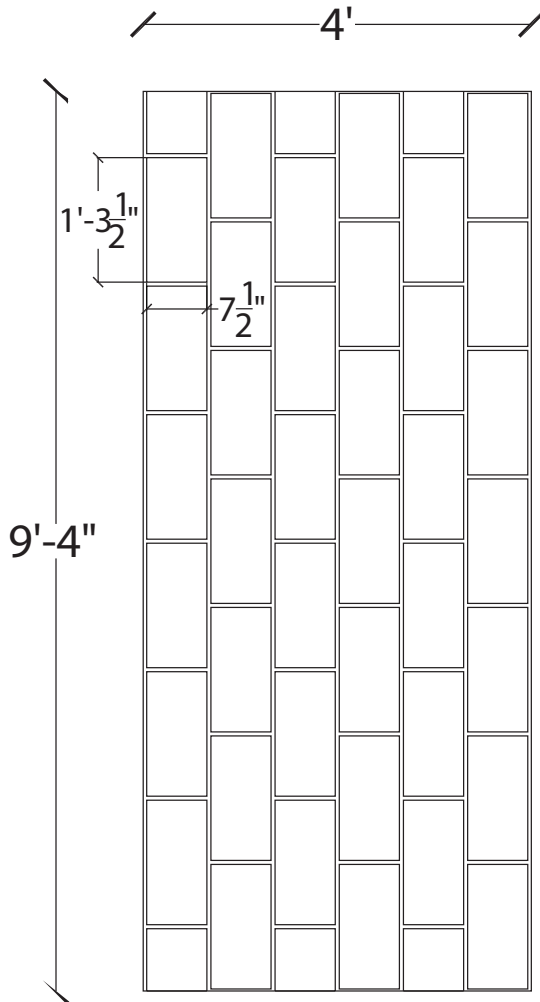

General Information:

The Styrene and ABS formliners are an economical solution for providing architectural pattern reproductions. The Styrene plastic formliner is a perfect alternative for single use applications which costs less than other liners. The ABS plastic formliner exhibits good impact resistance and excellent overall performance. Its reuse factor is 10, subject to pattern configuration, proper handling and jobsite configurations.

Care and Handling:

To protect from thermal deformation, formliners should not be exposed to temperatures above 140°F (60°C). To avoid discoloration from sunlight exposure, formliners should be covered with a tarpaulin when not in use. This helps prolong the life of the material and keeps the material clean.

Form Liners are subject to thermal expansion and contraction +/- 1/8" @ 70°F. Keep away from steam, acids, and certain fuels.



Styrene	ABS
Product Code #	Product Code #
F70331	F70271
Uses	Uses
1	Up to 10
Material Thickness	Material Thickness
.090	.110
Standard Dimensions	Standard Dimensions
9'-4" x 4'	9'-4" x 4'
Color	Color
White	Gray

DAYTON[®] SUPERIOR **8" x 16" ROCK FACE STACKED BOND**
Thermoform Plastic Formliner

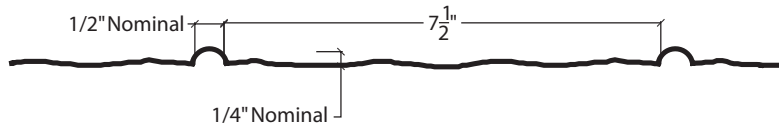
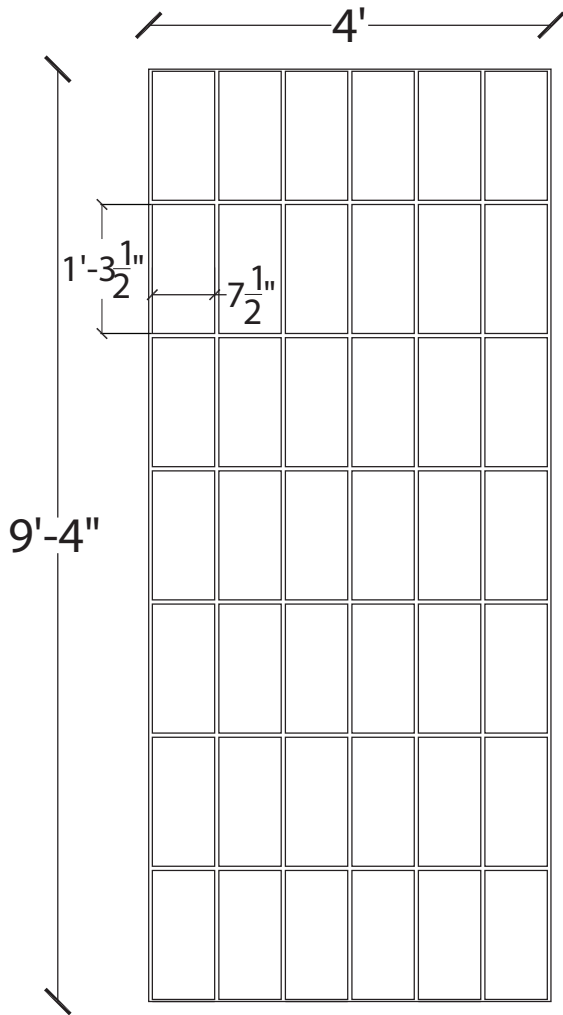

General Information:

The Styrene and ABS formliners are an economical solution for providing architectural pattern reproductions. The Styrene plastic formliner is a perfect alternative for single use applications which costs less than other liners. The ABS plastic formliner exhibits good impact resistance and excellent overall performance. Its reuse factor is 10, subject to pattern configuration, proper handling and jobsite configurations.

Care and Handling:

To protect from thermal deformation, formliners should not be exposed to temperatures above 140°F (60°C). To avoid discoloration from sunlight exposure, formliners should be covered with a tarpaulin when not in use. This helps prolong the life of the material and keeps the material clean.

Form Liners are subject to thermal expansion and contraction +/- 1/8" @ 70°F. Keep away from steam, acids, and certain fuels.



Styrene	ABS
Product Code #	Product Code #
F70332	F70272
Uses	Uses
1	Up to 10
Material Thickness	Material Thickness
.090	.110
Standard Dimensions	Standard Dimensions
9'-4" x 4'	9'-4" x 4'
Color	Color
White	Gray

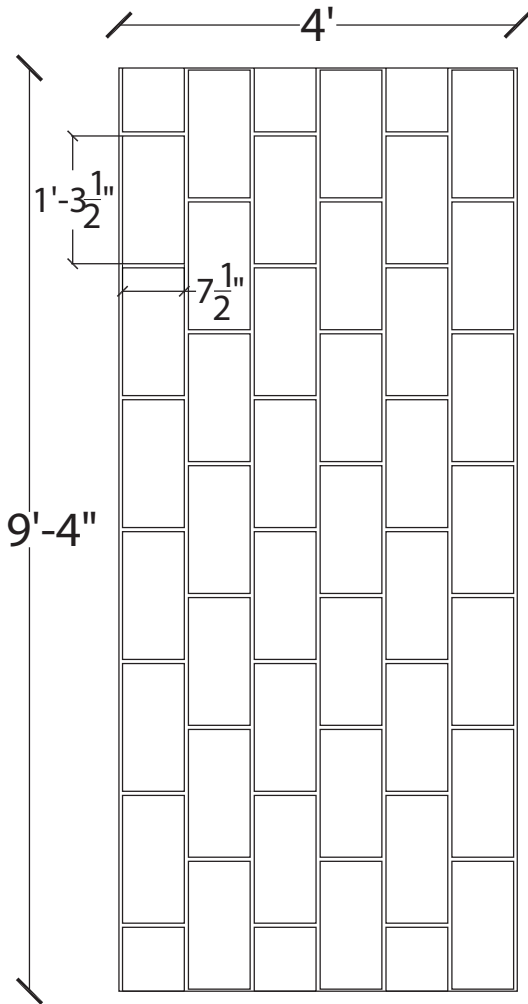

General Information:

The Styrene and ABS formliners are an economical solution for providing architectural pattern reproductions. The Styrene plastic formliner is a perfect alternative for single use applications which costs less than other liners. The ABS plastic formliner exhibits good impact resistance and excellent overall performance. Its reuse factor is 10, subject to pattern configuration, proper handling and jobsite configurations.

Care and Handling:

To protect from thermal deformation, formliners should not be exposed to temperatures above 140°F (60°C). To avoid discoloration from sunlight exposure, formliners should be covered with a tarpaulin when not in use. This helps prolong the life of the material and keeps the material clean.

Form Liners are subject to thermal expansion and contraction +/- 1/8" @ 70°F. Keep away from steam, acids, and certain fuels.

Styrene	ABS
Product Code #	Product Code #
F70333	F70273
Uses	Uses
1	Up to 10
Material Thickness	Material Thickness
.090	.110
Standard Dimensions	Standard Dimensions
9'-4" x 4'	9'-4" x 4'
Color	Color
White	Gray



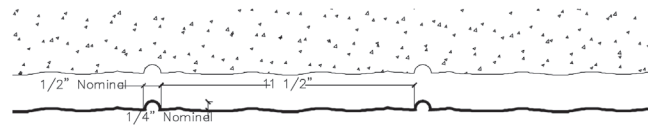
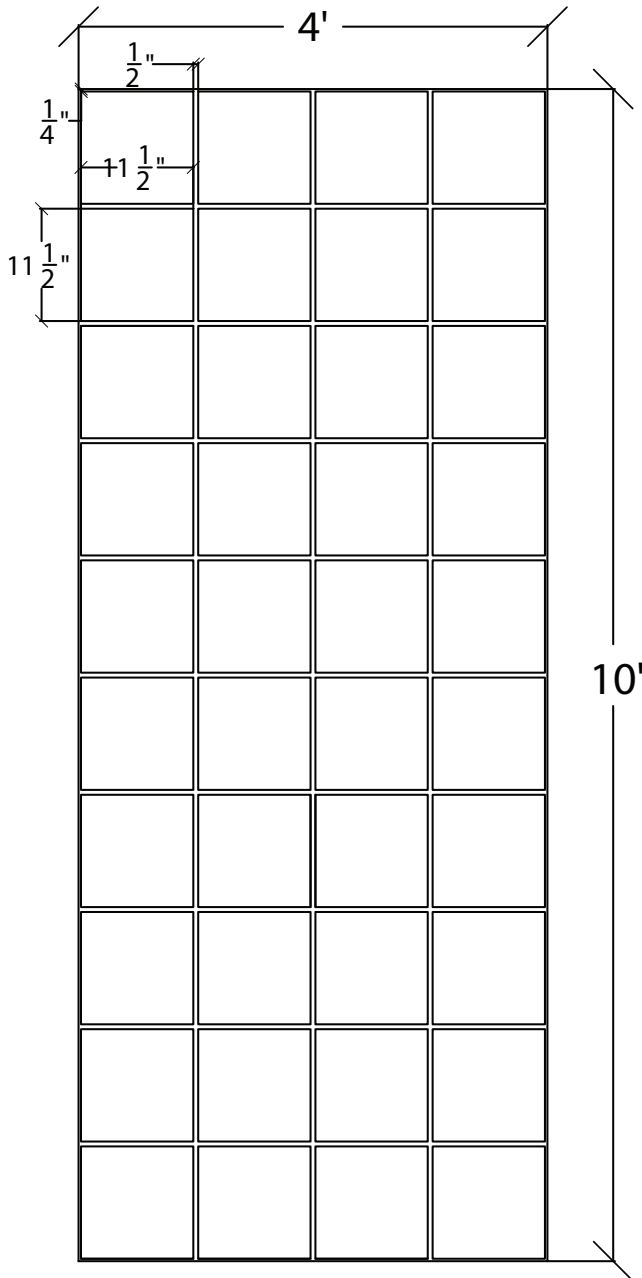

General Information:

The Styrene and ABS formliners are an economical solution for providing architectural pattern reproductions. The Styrene plastic formliner is a perfect alternative for single use applications which costs less than other liners. The ABS plastic formliner exhibits good impact resistance and excellent overall performance. Its reuse factor is 10, subject to pattern configuration, proper handling and jobsite configurations.

Care and Handling:

To protect from thermal deformation, formliners should not be exposed to temperatures above 140°F (60°C). To avoid discoloration from sunlight exposure, formliners should be covered with a tarpaulin when not in use. This helps prolong the life of the material and keeps the material clean.

Form Liners are subject to thermal expansion and contraction +/- 1/8" @ 70°F. Keep away from steam, acids, and certain fuels.

Styrene	ABS
Product Code #	Product Code #
F947042	F940011
Uses	Uses
1	Up to 10
Material Thickness	Material Thickness
.090	.110
Standard Dimensions	Standard Dimensions
4' x 10'	4' x 10'
Color	Color
White	Gray



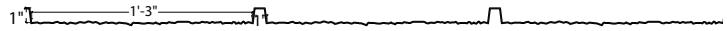
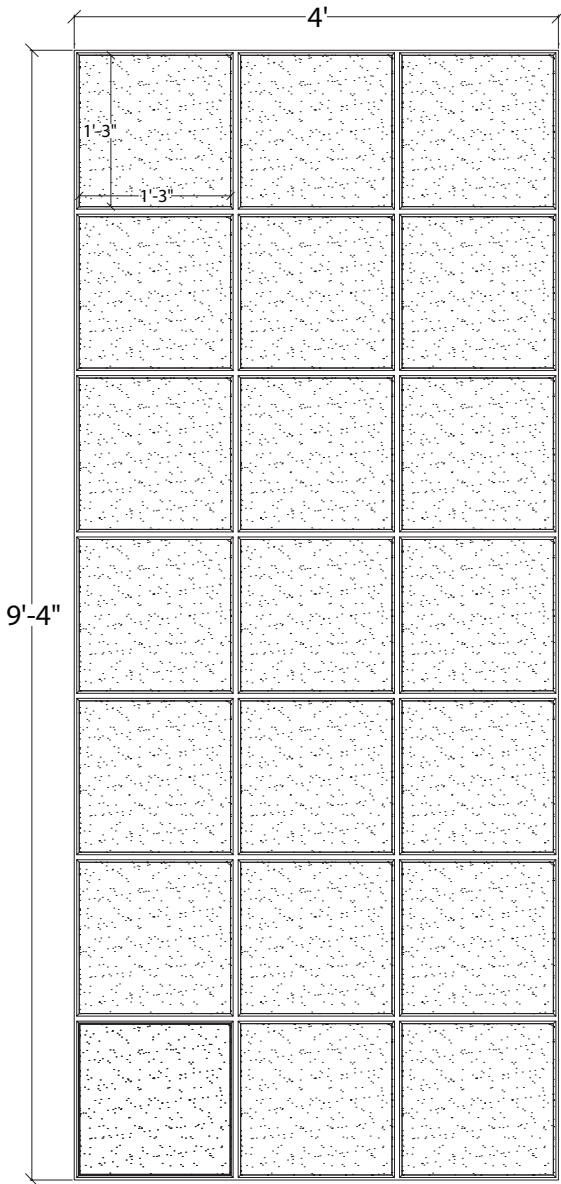

General Information:

The Styrene and ABS formliners are an economical solution for providing architectural pattern reproductions. The Styrene plastic formliner is a perfect alternative for single use applications which costs less than other liners. The ABS plastic formliner exhibits good impact resistance and excellent overall performance. Its reuse factor is 10, subject to pattern configuration, proper handling and jobsite configurations.

Care and Handling:

To protect from thermal deformation, formliners should not be exposed to temperatures above 140°F (60°C). To avoid discoloration from sunlight exposure, formliners should be covered with a tarpaulin when not in use. This helps prolong the life of the material and keeps the material clean.

Form Liners are subject to thermal expansion and contraction +/- 1/8" @ 70°F. Keep away from steam, acids, and certain fuels.

Styrene	ABS
Product Code #	Product Code #
F70607	F70635
Uses	Uses
1	Up to 10
Material Thickness	Material Thickness
.090	.110
Standard Dimensions	Standard Dimensions
9'-4" x 4'	9'-4" x 4'
Color	Color
White	Gray

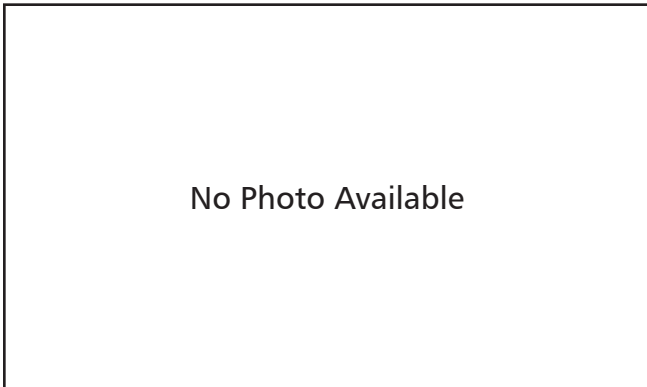

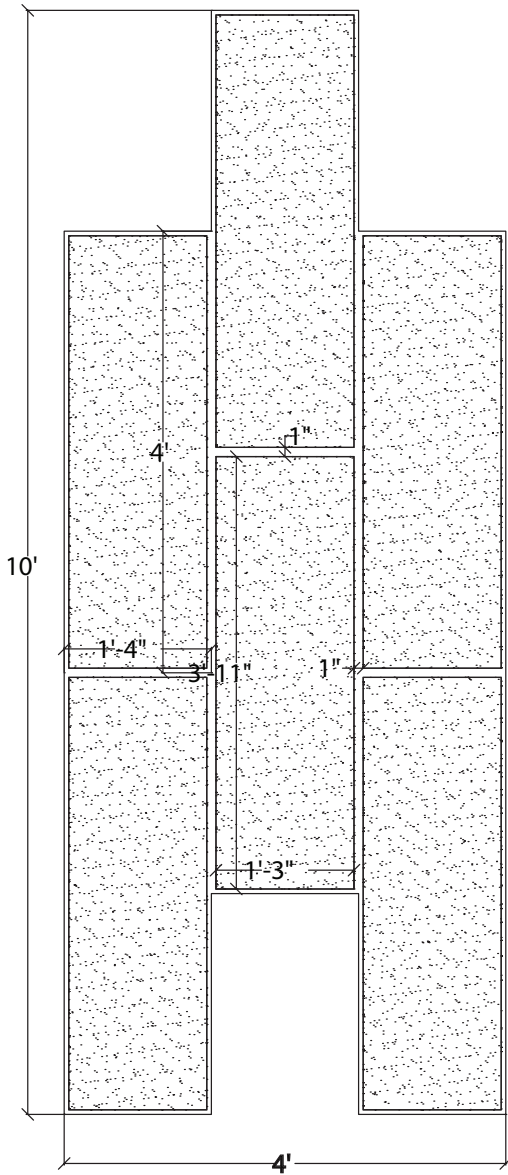

General Information:

The Styrene and ABS formliners are an economical solution for providing architectural pattern reproductions. The Styrene plastic formliner is a perfect alternative for single use applications which costs less than other liners. The ABS plastic formliner exhibits good impact resistance and excellent overall performance. Its reuse factor is 10, subject to pattern configuration, proper handling and jobsite configurations.

Care and Handling:

To protect from thermal deformation, formliners should not be exposed to temperatures above 140°F (60°C). To avoid discoloration from sunlight exposure, formliners should be covered with a tarpaulin when not in use. This helps prolong the life of the material and keeps the material clean.

Form Liners are subject to thermal expansion and contraction +/- 1/8" @ 70°F. Keep away from steam, acids, and certain fuels.

Styrene	ABS
Product Code #	Product Code #
F70608	F70636
Uses	Uses
1	Up to 10
Material Thickness	Material Thickness
.090	.110
Standard Dimensions	Standard Dimensions
10' x 4'	10' x 4'
Color	Color
White	Gray

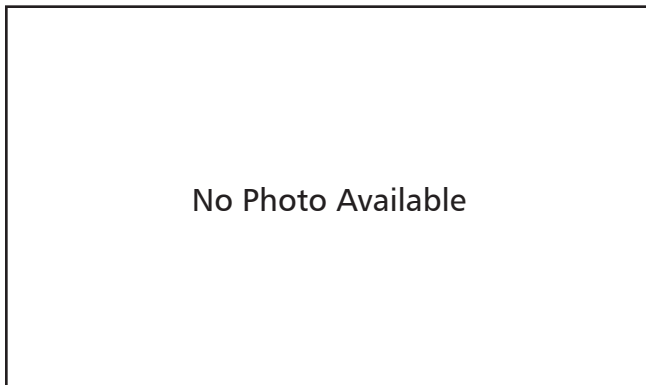

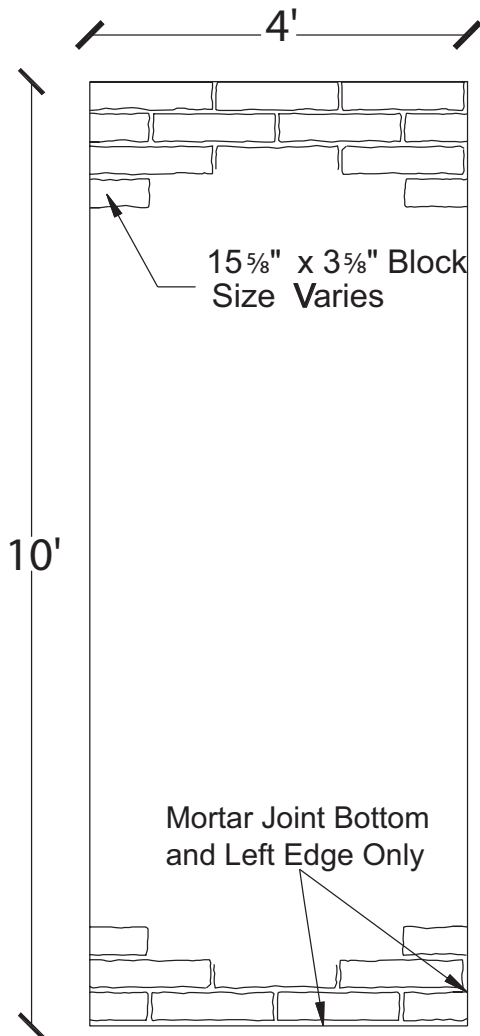

General Information:

The Styrene and ABS formliners are an economical solution for providing architectural pattern reproductions. The Styrene plastic formliner is a perfect alternative for single use applications which costs less than other liners. The ABS plastic formliner exhibits good impact resistance and excellent overall performance. Its reuse factor is 10, subject to pattern configuration, proper handling and jobsite configurations.

Care and Handling:

To protect from thermal deformation, formliners should not be exposed to temperatures above 140°F (60°C). To avoid discoloration from sunlight exposure, formliners should be covered with a tarpaulin when not in use. This helps prolong the life of the material and keeps the material clean.

Form Liners are subject to thermal expansion and contraction +/- 1/8" @ 70°F. Keep away from steam, acids, and certain fuels.

Styrene	ABS
Product Code #	Product Code #
F30734	F30426
Uses	Uses
1	Up to 10
Material Thickness	Material Thickness
.090	.110
Standard Dimensions	Standard Dimensions
4' x 10'	4' x 10'
Color	Color
White	Gray

